

AUGLÝSING

um innleiðingu á viðauka II um staðlaðar matsaðferðir fyrir hávaða í tilskipun framkvæmdastjórnarinnar (ESB) 2015/996 frá 19. maí 2015 um að koma á sameiginlegum matsaðferðum fyrir hávaða samkvæmt tilskipun Evrópuþingsins og ráðsins 2002/49/EB, sbr. reglugerð nr. 830/2019.

1. gr.

Eftirfarandi viðauki öðlast gildi hér á landi með reglugerð nr. 830/2019 um (1.) breytingu á reglugerð nr. 1000/2005 um kortlagningu hávaða og aðgerðaáætlanir sem birt er í B-deild Stjórnartíðinda: Viðauki II um staðlaðar matsaðferðir fyrir hávaða í tilskipun framkvæmdastjórnarinnar (ESB) 2015/996 frá 19. maí 2015 um að koma á sameiginlegum matsaðferðum fyrir hávaða samkvæmt tilskipun Evrópuþingsins og ráðsins 2002/49/EB, sem vísað er til í tölulið 32ga VI. kafla XX. viðauka samningsins um Evrópska efnahagssvæðið eins og honum var breytt með ákvörðun sameiginlegu EES-nefndarinnar nr. 207/2017, þann 27. október 2017. Viðaukinn er birtur á ensku í fylgiskjali með auglýsingu þessari.

2. gr.

Auglýsing þessi er sett með stoð í 15. tölul. 5. gr. laga nr. 7/1998 um hollustuhætti og mengunarvarnir, sbr. heimild í 2. mgr. 4. gr., sbr. 2. mgr. 3. gr. laga nr. 15/2005 um Stjórnartíðindi og Lögbirtingablað og öðlast þegar gildi.

Þetta er hér með gert almenningi kunnugt.

Umhverfis- og auðlindaráðuneytinu, 3. september 2019.

Guðmundur Ingi Guðbrandsson.

Sigríður Auður Arnardóttir.

Fylgiskjal.

ANNEX

ASSESSMENT METHODS FOR THE NOISE INDICATORS

(Referred to in Article 6 of Directive 2002/49/EC)

1. INTRODUCTION

The values of L_{den} and L_{night} shall be determined at the assessment positions by computation, according to the method set out in Chapter 2 and the data described in Chapter 3. Measurements may be performed according to Chapter 4.

2. COMMON NOISE ASSESSMENT METHODS

2.1. **General provisions — Road traffic, railway and industrial noise**2.1.1. *Indicators, frequency range and band definitions*

Noise calculations shall be defined in the frequency range from 63 Hz to 8 kHz. Frequency band results shall be provided at the corresponding frequency interval.

Calculations are performed in octave bands for road traffic, railway traffic and industrial noise, except for the railway noise source sound power, that uses third octave bands. For road traffic, railway traffic and industrial noise, based on these octave band results, the A-weighted long term average sound pressure level for the day, evening and night period, as defined in Annex 1 and referred to in Art. 5 of Directive 2002/49/EC, is computed by summation over all frequencies:

$$L_{Aeq,T} = 10 \times \lg \sum_{i=1} 10^{(L_{eq,T,i} + A_i)/10} \quad (2.1.1)$$

where

A_i denotes the A-weighting correction according to IEC 61672-1

i = frequency band index

and T is the time period corresponding to day, evening or night.

Noise parameters:

L_p	Instantaneous sound pressure level	[dB] (re. $2 \cdot 10^{-5}$ Pa)
$L_{Aeq,LT}$	Global long-term sound level L_{Aeq} due to all sources and image sources at point R	[dB] (re. $2 \cdot 10^{-5}$ Pa)
L_W	'In situ' sound power level of a point source (moving or steady)	[dB] (re. 10^{-12} W)
$L_{W_i,dir}$	Directional 'in situ' sound power level for the i -th frequency band	[dB] (re. 10^{-12} W)
$L_{W'}^r$	Average 'in situ' sound power level per metre of source line	[dB/m] (re. 10^{-12} W)

Other physical parameters:

p	r.m.s. of the instantaneous sound pressure	[Pa]
p_0	Reference sound pressure = $2 \cdot 10^{-5}$ Pa	[Pa]
W_0	Reference sound power = 10^{-12} W	[watt]

2.1.2. Quality framework

Accuracy of input values

All input values affecting the emission level of a source shall be determined with at least the accuracy corresponding to an uncertainty of ± 2 dB(A) in the emission level of the source (leaving all other parameters unchanged).

Use of default values

In the application of the method, the input data shall reflect the actual usage. In general there shall be no reliance on default input values or assumptions. Default input values and assumptions are accepted if the collection of real data is associated with disproportionately high costs.

Quality of the software used for the calculations

Software used to perform the calculations shall prove compliance with the methods herewith described by means of certification of results against test cases.

2.2. Road traffic noise

2.2.1. Source description

Classification of vehicles

The road traffic noise source shall be determined by combining the noise emission of each individual vehicle forming the traffic flow. These vehicles are grouped into five separate categories with regard to their characteristics of noise emission:

Category 1: Light motor vehicles

Category 2: Medium heavy vehicles

Category 3: Heavy vehicles

Category 4: Powered two-wheelers

Category 5: Open category

In the case of powered two-wheelers, two separate subclasses are defined for mopeds and more powerful motorcycles, since they operate in very different driving modes and their numbers usually vary widely.

The first four categories shall be used, and the fifth category is optional. It is foreseen for new vehicles that may be developed in the future and may be sufficiently different in their noise emission to require an additional category to be defined. This category could cover, for example, electric or hybrid vehicles or any vehicle developed in the future substantially different from those in categories 1 to 4.

The details of the different vehicle classes are given in Table [2.2.a].

Table [2.2.a]

Vehicle classes

Category	Name	Description	Vehicle category in EC Whole Vehicle Type Approval ⁽¹⁾
1	Light motor vehicles	Passenger cars, delivery vans \leq 3,5 tons, SUVs ⁽²⁾ , MPVs ⁽³⁾ including trailers and caravans	M1 and N1
2	Medium heavy vehicles	Medium heavy vehicles, delivery vans $>$ 3,5 tons, buses, motorhomes, etc. with two axles and twin tyre mounting on rear axle	M2, M3 and N2, N3
3	Heavy vehicles	Heavy duty vehicles, touring cars, buses, with three or more axles	M2 and N2 with trailer, M3 and N3
4	Powered two-wheelers	4a Two-, Three- and Four-wheel Mopeds	L1, L2, L6
		4b Motorcycles with and without sidecars, Tri-cycles and Quadricycles	L3, L4, L5, L7
5	Open category	To be defined according to future needs	N/A

⁽¹⁾ Directive 2007/46/EC of the European Parliament and of the Council of 5 September 2007 establishing a framework for the approval of motor vehicles and their trailers, and of systems, components and separate technical units intended for such vehicles (OJ L 263, 9.10.2007, p. 1).

⁽²⁾ Sport Utility Vehicles.

⁽³⁾ Multi-Purpose Vehicles.

Number and position of equivalent sound sources

In this method, each vehicle (category 1, 2, 3, 4 and 5) is represented by one single point source radiating uniformly into the 2π half space above the ground. The first reflection on the road surface is treated implicitly. As depicted in Figure [2.2.a], this point source is placed 0,05 m above the road surface.

Figure [2.2.a]

Location of equivalent point source on light vehicles (category 1), heavy vehicles (categories 2 and 3) and two-wheelers (category 4)

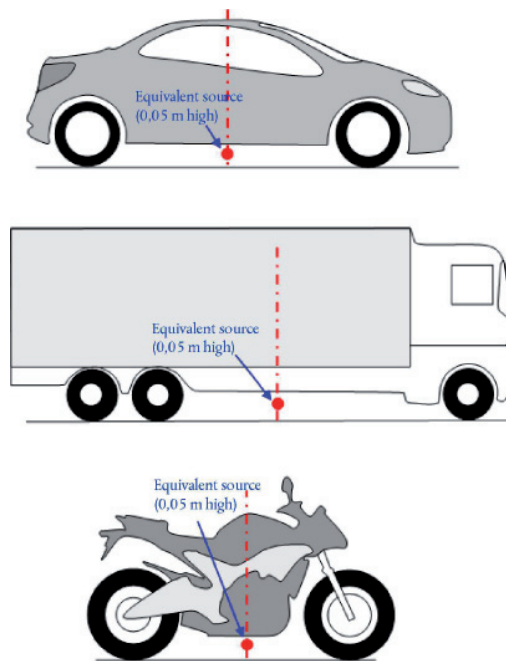

The traffic flow is represented by a source line. In the modelling of a road with multiple lanes, each lane should ideally be represented by a source line placed in the centre of each lane. However, it is also acceptable to model one source line in the middle of a two way road or one source line per carriageway in the outer lane of multi-lane roads.

Sound power emission

General considerations

The sound power of the source is defined in the 'semi-free field', thus the sound power includes the effect of the reflection of the ground immediately under the modelled source where there are no disturbing objects in its immediate surroundings except for the reflection on the road surface not immediately under the modelled source.

Traffic flow

The noise emission of a traffic flow is represented by a source line characterised by its directional sound power per metre per frequency. This corresponds to the sum of the sound emission of the individual vehicles in the traffic flow, taking into account the time spent by the vehicles in the road section considered. The implementation of the individual vehicle in the flow requires the application of a traffic flow model.

If a steady traffic flow of Q_m vehicles of category m per hour is assumed, with an average speed v_m (in km/h), the directional sound power per metre in frequency band i of the source line $L_{W',eq,line,i,m}$ is defined by:

$$L_{W',eq,line,i,m} = L_{W,i,m} + 10 \times \lg\left(\frac{Q_m}{1\,000 \times v_m}\right) \quad (2.2.1)$$

where $L_{W,i,m}$ is the directional sound power of a single vehicle. $L_{W',m}$ is expressed in dB (re. 10^{-12} W/m). These sound power levels are calculated for each octave band i from 125 Hz to 4 kHz.

Traffic flow data Q_m shall be expressed as yearly average per hour, per time period (day-evening-night), per vehicle class and per source line. For all categories, input traffic flow data derived from traffic counting or from traffic models shall be used.

The speed v_m is a representative speed per vehicle category: in most cases the lower of the maximum legal speed for the section of road and the maximum legal speed for the vehicle category. If local measurement data is unavailable the maximum legal speed for the vehicle category shall be used.

Individual vehicle

In the traffic flow, all vehicles of category m are assumed to drive at the same speed, i.e. v_m , the average speed of the flow of vehicles of the category.

A road vehicle is modelled by a set of mathematical equations representing the two main noise sources:

1. Rolling noise due to the tyre/road interaction;
2. Propulsion noise produced by the driveline (engine, exhaust, etc.) of the vehicle.

Aerodynamic noise is incorporated in the rolling noise source.

For light, medium and heavy motor vehicles (categories 1, 2 and 3), the total sound power corresponds to the energetic sum of the rolling and the propulsion noise. Thus, the total sound power level of the source lines $m = 1, 2$ or 3 is defined by:

$$L_{W,i,m}(v_m) = 10 \times \lg(10^{L_{WR,i,m}(v_m)/10} + 10^{L_{WP,i,m}(v_m)/10}) \quad (2.2.2)$$

where $L_{WR,i,m}$ is the sound power level for rolling noise and $L_{WP,i,m}$ is the sound power level for propulsion noise. This is valid on all speed ranges. For speeds less than 20 km/h it shall have the same sound power level as defined by the formula for $v_m = 20$ km/h.

For two-wheelers (category 4), only propulsion noise is considered for the source:

$$L_{W,i,m=4}(v_m=4) = L_{WP,i,m=4}(v_m=4) \quad (2.2.3)$$

This is valid on all speed ranges. For speeds less than 20 km/h it shall have the same sound power level as defined by the formula for $v_m = 20$ km/h.

2.2.2. Reference conditions

The source equations and coefficients are valid for the following reference conditions:

- a constant vehicle speed
- a flat road
- an air temperature $\tau_{ref} = 20$ °C

- a virtual reference road surface, consisting of an average of dense asphalt concrete 0/11 and stone mastic asphalt 0/11, between 2 and 7 years old and in a representative maintenance condition
- a dry road surface
- no studded tyres.

2.2.3. Rolling noise

General equation

The rolling noise sound power level in the frequency band i for a vehicle of class $m = 1, 2$ or 3 is defined as:

$$L_{WR,i,m} = A_{R,i,m} + B_{R,i,m} \times \lg\left(\frac{v_m}{v_{ref}}\right) + \Delta L_{WR,i,m} \quad (2.2.4)$$

The coefficients $A_{R,i,m}$ and $B_{R,i,m}$ are given in octave bands for each vehicle category and for a reference speed $v_{ref} = 70$ km/h. $\Delta L_{WR,i,m}$ corresponds to the sum of the correction coefficients to be applied to the rolling noise emission for specific road or vehicle conditions deviating from the reference conditions:

$$\Delta L_{WR,i,m} = \Delta L_{WR,road,i,m} + \Delta L_{studdedtyres,i,m} + \Delta L_{WR,acc,i,m} + \Delta L_{W,temp} \quad (2.2.5)$$

$\Delta L_{WR,road,i,m}$ accounts for the effect on rolling noise of a road surface with acoustic properties different from those of the virtual reference surface as defined in Chapter 2.2.2. It includes both the effect on propagation and on generation.

$\Delta L_{studdedtyres,i,m}$ is a correction coefficient accounting for the higher rolling noise of light vehicles equipped with studded tyres.

$\Delta L_{WR,acc,i,m}$ accounts for the effect on rolling noise of a crossing with traffic lights or a roundabout. It integrates the effect on noise of the speed variation.

$\Delta L_{W,temp}$ is a correction term for an average temperature τ different from the reference temperature $\tau_{ref} = 20$ °C.

Correction for studded tyres

In situations where a significant number of light vehicles in the traffic flow use studded tyres during several months every year, the induced effect on rolling noise shall be taken into account. For each vehicle of category $m = 1$ equipped with studded tyres, a speed-dependent increase in rolling noise emission is evaluated by:

$$\Delta_{stud,i}(v) = \begin{cases} a_i + b_i \times \lg(50/70) & \text{for } v < 50 \text{ km/h} \\ a_i + b_i \times \lg(v/70) & \text{for } 50 \leq v \leq 90 \text{ km/h} \\ a_i + b_i \times \lg(90/70) & \text{for } v > 90 \text{ km/h} \end{cases} \quad (2.2.6)$$

where coefficients a_i and b_i are given for each octave band.

The increase in rolling noise emission shall only be attributed according to the proportion of light vehicles with studded tyres and during a limited period T_s (in months) over the year. If $Q_{stud,ratio}$ is the average ratio of the total volume of light vehicles per hour equipped with studded tyres during the period T_s (in months), then the yearly average proportion of vehicles equipped with studded tyres p_s is expressed by:

$$p_s = Q_{stud,ratio} \times \frac{T_s}{12} \quad (2.2.7)$$

The resulting correction to be applied to the rolling sound power emission due to the use of studded tyres for vehicles of category $m = 1$ in frequency band i shall be:

$$\Delta L_{\text{studdedtyres},i,m=1} = 10 \times \lg \left[(1 - p_s) + p_s 10^{\frac{\Delta_{\text{stud},i,m=1}}{10}} \right] \quad (2.2.8)$$

For vehicles of all other categories no correction shall be applied:

$$\Delta L_{\text{studdedtyres},i,m \neq 1} = 0 \quad (2.2.9)$$

Effect of air temperature on rolling noise correction

The air temperature affects rolling noise emission; the rolling sound power level decreases when the air temperature increases. This effect is introduced in the road surface correction. Road surface corrections are usually evaluated at an air temperature of $\tau_{\text{ref}} = 20$ °C. In the case of a different yearly average air temperature °C, the road surface noise shall be corrected by:

$$\Delta L_{W,\text{temp},m}(\tau) = K_m \times (\tau_{\text{ref}} - \tau) \quad (2.2.10)$$

The correction term is positive (i.e. noise increases) for temperatures lower than 20 °C and negative (i.e. noise decreases) for higher temperatures. The coefficient K depends on the road surface and the tyre characteristics and in general exhibits some frequency dependence. A generic coefficient $K_{m=1} = 0,08$ dB/°C for light vehicles (category 1) and $K_{m=2} = K_{m=3} = 0,04$ dB/°C for heavy vehicles (categories 2 and 3) shall be applied for all road surfaces. The correction coefficient shall be applied equally on all octave bands from 63 to 8 000 Hz.

2.2.4. Propulsion noise

General equation

The propulsion noise emission includes all contributions from engine, exhaust, gears, air intake, etc. The propulsion noise sound power level in the frequency band i for a vehicle of class m is defined as:

$$L_{WP,i,m} = A_{P,i,m} + B_{P,i,m} \times \frac{(v_m - v_{\text{ref}})}{v_{\text{ref}}} + \Delta L_{WP,i,m} \quad (2.2.11)$$

The coefficients $A_{P,i,m}$ and $B_{P,i,m}$ are given in octave bands for each vehicle category and for a reference speed $v_{\text{ref}} = 70$ km/h.

$\Delta L_{WP,i,m}$ corresponds to the sum of the correction coefficients to be applied to the propulsion noise emission for specific driving conditions or regional conditions deviating from the reference conditions:

$$\Delta L_{WP,i,m} = \Delta L_{WP,\text{road},i,m} + \Delta L_{WP,\text{grad},i,m} + \Delta L_{WP,\text{acc},i,m} \quad (2.2.12)$$

$\Delta L_{WP,\text{road},i,m}$ accounts for the effect of the road surface on the propulsion noise via absorption. The calculation shall be performed according to Chapter 2.2.6.

$\Delta L_{WP,\text{acc},i,m}$ and $\Delta L_{WP,\text{grad},i,m}$ account for the effect of road gradients and of vehicle acceleration and deceleration at intersections. They shall be calculated according to Chapters 2.2.4 and 2.2.5 respectively.

Effect of road gradients

The road gradient has two effects on the noise emission of the vehicle: first, it affects the vehicle speed and thus the rolling and propulsion noise emission of the vehicle; second, it affects both the engine load and the engine speed via the choice of gear and thus the propulsion noise emission of the vehicle. Only the effect on the propulsion noise is considered in this section, where a steady speed is assumed.

The effect of the road gradient on the propulsion noise is taken into account by a correction term $\Delta L_{WP,grad,m}$ which is a function of the slope s (in %), the vehicle speed v_m (in km/h) and the vehicle class m . In the case of a bi-directional traffic flow, it is necessary to split the flow into two components and correct half for uphill and half for downhill. The correction term is attributed to all octave bands equally:

For $m = 1$

$$\Delta L_{WP,grad,i,m=1}(v_m) = \begin{cases} \frac{\text{Min}(12\%; -s) - 6\%}{1\%} & \text{for } s < -6\% \\ 0 & \text{for } -6\% \leq s \leq 2\% \\ \frac{\text{Min}(12\%; s) - 2\%}{1,5\%} \times \frac{v_m}{100} & \text{for } s > 2\% \end{cases} \quad (2.2.13)$$

For $m = 2$

$$\Delta L_{WP,grad,i,m=2}(v_m) = \begin{cases} \frac{\text{Min}(12\%; -s) - 4\%}{0,7\%} \times \frac{v_m - 20}{100} & \text{for } s < -4\% \\ 0 & \text{for } -4\% \leq s \leq 0\% \\ \frac{\text{Min}(12\%; s)}{1\%} \times \frac{v_m}{100} & \text{for } s > 0\% \end{cases} \quad (2.2.14)$$

For $m = 3$

$$\Delta L_{WP,grad,i,m=3}(v_m) = \begin{cases} \frac{\text{Min}(12\%; -s) - 4\%}{0,5\%} \times \frac{v_m - 10}{100} & \text{for } s < -4\% \\ 0 & \text{for } -4\% \leq s \leq 0\% \\ \frac{\text{Min}(12\%; s)}{0,8\%} \times \frac{v_m}{100} & \text{for } s > 0\% \end{cases} \quad (2.2.15)$$

For $m = 4$

$$\Delta L_{WP,grad,i,m=4} = 0 \quad (2.2.16)$$

The correction $\Delta L_{WP,grad,m}$ implicitly includes the effect of slope on speed.

2.2.5. Effect of the acceleration and deceleration of vehicles

Before and after crossings with traffic lights and roundabouts a correction shall be applied for the effect of acceleration and deceleration as described below.

The correction terms for rolling noise, $\Delta L_{WR,acc,m,k}$, and for propulsion noise, $\Delta L_{WP,acc,m,k}$, are linear functions of the distance x (in m) of the point source to the nearest intersection of the respective source line with another source line. They are attributed to all octave bands equally:

$$\Delta L_{WR,acc,m,k} = C_{R,m,k} \times \text{Max}\left(1 - \frac{|x|}{100}; 0\right) \quad (2.2.17)$$

$$\Delta L_{WP,acc,m,k} = C_{P,m,k} \times \text{Max}\left(1 - \frac{|x|}{100}; 0\right) \quad (2.2.18)$$

The coefficients $C_{r,m,k}$ and $C_{p,m,k}$ depend on the kind of junction k ($k = 1$ for a crossing with traffic lights; $k = 2$ for a roundabout) and are given for each vehicle category. The correction includes the effect of change in speed when approaching or moving away from a crossing or a roundabout.

Note that at a distance $|x| \geq 100$ m, $\Delta L_{WR,acc,m,k} = \Delta L_{WP,acc,m,k} = 0$.

2.2.6. Effect of the type of road surface

General principles

For road surfaces with acoustic properties different from those of the reference surface, a spectral correction term for both rolling noise and propulsion noise shall be applied.

The road surface correction term for the rolling noise emission is given by:

$$\Delta L_{WR,road,i,m} = \alpha_{i,m} + \beta_m \times \lg \left(\frac{v_m}{v_{ref}} \right) \quad (2.2.19)$$

where

$\alpha_{i,m}$ is the spectral correction in dB at reference speed v_{ref} for category m (1, 2 or 3) and spectral band i .

β_m is the speed effect on the rolling noise reduction for category m (1, 2 or 3) and is identical for all frequency bands.

The road surface correction term for the propulsion noise emission is given by:

$$\Delta L_{WP,road,i,m} = \min\{\alpha_{i,m}, 0\} \quad (2.2.20)$$

Absorbing surfaces decrease the propulsion noise, while non-absorbing surfaces do not increase it.

Age effect on road surface noise properties

The noise characteristics of road surfaces vary with age and the level of maintenance, with a tendency to become louder over time. In this method the road surface parameters are derived to be representative for the acoustic performance of the road surface type averaged over its representative lifetime and assuming proper maintenance.

2.3. Railway noise

2.3.1. Source description

Classification of vehicles

Definition of vehicle and train

For the purposes of this noise calculation method, a vehicle is defined as any single railway sub-unit of a train (typically a locomotive, a self-propelled coach, a hauled coach or a freight wagon) that can be moved independently and can be detached from the rest of the train. Some specific circumstances may occur for sub-units of a train that are a part of a non-detachable set, e.g. share one bogie between them. For the purpose of this calculation method, all these sub-units are grouped into a single vehicle.

For the purpose of this calculation method, a train consists of a series of coupled vehicles.

Table [2.3.a] defines a common language to describe the vehicle types included in the source database. It presents the relevant descriptors to be used to classify the vehicles in full. These descriptors correspond to properties of the vehicle, which affect the acoustic directional sound power per metre length of the equivalent source line modelled.

The number of vehicles for each type shall be determined on each of the track sections for each of the time periods to be used in the noise calculation. It shall be expressed as an average number of vehicles per hour, which is obtained by dividing the total number of vehicles travelling in a given time period by the duration in hours of this time period (e.g. 24 vehicles in 4 hours means 6 vehicles per hour). All vehicle types travelling on each track section shall be used.

Table [2.3.a]

Classification and descriptors for railway vehicles

Digit	1	2	3	4
Descriptor	Vehicle type	Number of axles per vehicle	Brake type	Wheel measure
Explanation of the descriptor	A letter that describes the type	The actual number of axles	A letter that describes the brake type	A letter that describes the noise reduction measure type
Possible descriptors	h high speed vehicle (> 200 km/h)	1	c cast-iron block	n no measure
	m self-propelled passenger coaches	2	k composite or sinter metal block	d dampers
	p hailed passenger coaches	3	n non-tread braked, like disc, drum, magnetic	s screens
	c city tram or light metro self-propelled and non-self-propelled coach	4		o other
	d diesel loco	etc.		
	e electric loco			
	a any generic freight vehicle			
	o other (i.e. maintenance vehicles etc.)			

Classification of tracks and support structure

The existing tracks may differ because there are several elements contributing to and characterising their acoustic properties. The track types used in this method are listed in Table [2.3.b] below. Some of the elements have a large influence on acoustic properties, while others have only secondary effects. In general, the most relevant elements influencing the railway noise emission are: railhead roughness, rail pad stiffness, track base, rail joints and radius of curvature of the track. Alternatively, the overall track properties can be defined and, in this case, the railhead roughness and the track decay rate according to ISO 3095 are the two acoustically essential parameters, plus the radius of curvature of the track.

A track section is defined as a part of a single track, on a railway line or station or depot, on which the track's physical properties and basic components do not change.

Table [2.3.b] defines a common language to describe the track types included in the source database.

Table [2.3.b]

Digit	1	2	3	4	5	6
Descriptor	Track base	Railhead Roughness	Rail pad type	Additional measures	Rail joints	Curvature
Explanation of the descriptor	Type of track base	Indicator for roughness	Represents an indication of the 'acoustic' stiffness	A letter describing acoustic device	Presence of joints and spacing	Indicate the radius of curvature in m
Codes allowed	B Ballast	E Well maintained and very smooth	S Soft (150-250 MN/m)	N None	N None	N Straight track
	S Slab track	M Normally maintained	M Medium (250 to 800 MN/m)	D Rail damper	S Single joint or switch	L Low (1 000-500 m)
	L Ballasted bridge	N Not well maintained	H Stiff (800-1 000 MN/m)	B Low barrier	D Two joints or switches per 100 m	M Medium (Less than 500 m and more than 300 m)
	N Non-ballasted bridge	B Not maintained and bad condition		A Absorber plate on slab track	M More than two joints or switches per 100 m	H High (Less than 300 m)
	T Embedded track			E Embedded rail		
	O Other			O Other		

Number and position of the equivalent sound sources

Figure [2.3.a]

Equivalent noise sources position

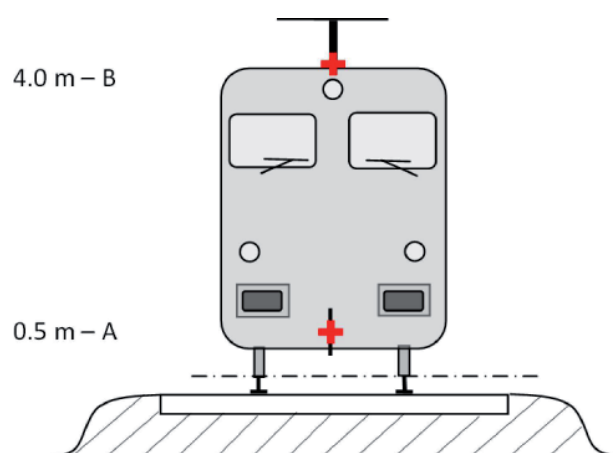

The different equivalent noise line sources are placed at different heights and at the centre of the track. All heights are referred to the plane tangent to the two upper surfaces of the two rails.

The equivalent sources include different physical sources (index p). These physical sources are divided into different categories depending on the generation mechanism, and are: (1) rolling noise (including not only rail and track base vibration and wheel vibration but also, where present, superstructure noise of the freight vehicles); (2) traction noise; (3) aerodynamic noise; (4) impact noise (from crossings, switches and junctions); (5) squeal noise and (6) noise due to additional effects such as bridges and viaducts.

- (1) The roughness of wheels and railheads, through three transmission paths to the radiating surfaces (rails, wheels and superstructure), constitutes the rolling noise. This is allocated to $h = 0,5$ m (radiating surfaces A) to represent the track contribution, including the effects of the surface of the tracks, especially slab tracks (in accordance with the propagation part), to represent the wheel contribution and to represent the contribution of the superstructure of the vehicle to noise (in freight trains).
- (2) The equivalent source heights for traction noise vary between 0,5 m (source A) and 4,0 m (source B), depending on the physical position of the component concerned. Sources such as gear transmissions and electric motors will often be at an axle height of 0,5 m (source A). Louvres and cooling outlets can be at various heights; engine exhausts for diesel-powered vehicles are often at a roof height of 4,0 m (source B). Other traction sources such as fans or diesel engine blocks may be at a height of 0,5 m (source A) or 4,0 m (source B). If the exact source height is in between the model heights, the sound energy is distributed proportionately over the nearest adjacent source heights.

For this reason, two source heights are foreseen by the method at 0,5 m (source A), 4,0 m (source B), and the equivalent sound power associated with each is distributed between the two depending on the specific configuration of the sources on the unit type.

- (3) Aerodynamic noise effects are associated with the source at 0,5 m (representing the shrouds and the screens, source A), and the source at 4,0 m (modelling all over roof apparatus and pantograph, source B). The choice of 4,0 m for pantograph effects is known to be a simple model, and has to be considered carefully if the objective is to choose an appropriate noise barrier height.

- (4) Impact noise is associated with the source at 0,5 m (source A).
- (5) Squeal noise is associated with the sources at 0,5 m (source A).
- (6) Bridge noise is associated with the source at 0,5 m (source A).

2.3.2. Sound power emission

General equations

Individual vehicle

The model for railway traffic noise, analogously to road traffic noise, describes the noise sound power emission of a specific combination of vehicle type and track type which fulfils a series of requirements described in the vehicle and track classification, in terms of a set of sound power per each vehicle ($L_{w,0}$).

Traffic flow

The noise emission of a traffic flow on each track shall be represented by a set of 2 source lines characterised by its directional sound power per metre per frequency band. This corresponds to the sum of the sound emissions due to the individual vehicles passing by in the traffic flow and, in the specific case of stationary vehicles, taking into account the time spent by the vehicles in the railway section under consideration.

The directional sound power per metre per frequency band, due to all the vehicles passing by each track section on the track type (j), is defined:

- for each frequency band (i),
- for each given source height (h) (for sources at 0,5 m h = 1, at 4,0 m h = 2),

and is the energy sum of all contributions from all vehicles running on the specific j-th track section. These contributions are:

- from all vehicle types (t)
- at their different speeds (s)
- under the particular running conditions (constant speed) (c)
- for each physical source type (rolling, impact, squeal, traction, aerodynamic and additional effects sources such as for example bridge noise) (p).

To calculate the directional sound power per metre (input to the propagation part) due to the average mix of traffic on the j-th track section, the following is used:

$$L_{W',eq,T,dir,i} = 10 \cdot \lg \left(\sum_{x=1}^X 10^{L_{w',eq,line,x} / 10} \right) \quad (2.3.1)$$

where

T_{ref} = reference time period for which the average traffic is considered

- x = total number of existing combinations of i, t, s, c, p for each j -th track section
- t = index for vehicle types on the j -th track section
- s = index for train speed: there are as many indexes as the number of different average train speeds on the j -th track section
- c = index for running conditions: 1 (for constant speed), 2 (idling)
- p = index for physical source types: 1 (for rolling and impact noise), 2 (curve squeal), 3 (traction noise), 4 (aerodynamic noise), 5 (additional effects)
- $L_{W',eq,line,x}$ = x -th directional sound power per metre for a source line of one combination of t, s, c, p on each j -th track section

If a steady flow of Q vehicles per hour is assumed, with an average speed v , on average at each moment in time there will be an equivalent number of Q/v vehicles per unit length of the railway section. The noise emission of the vehicle flow in terms of directional sound power per metre $L_{W',eq,line}$ (expressed in dB/m (re. 10^{-12} W)) is integrated by:

$$L_{W',eq,line,i}(\psi,\varphi) = L_{W,0,dir,i}(\psi,\varphi) + 10 \times \lg\left(\frac{Q}{1000v}\right) \quad (\text{for } c = 1) \quad (2.3.2)$$

where

- Q is the average number of vehicles per hour on the j -th track section for vehicle type t , average train speed s and running condition c
- v is their speed on the j -th track section for vehicle type t and average train speed s
- $L_{W,0,dir}$ is the directional sound power level of the specific noise (rolling, impact, squeal, braking, traction, aerodynamic, other effects) of a single vehicle in the directions ψ, φ defined with respect to the vehicle's direction of movement (see Figure [2.3.b]).

In the case of a stationary source, as during idling, it is assumed that the vehicle will remain for an overall time T_{idle} at a location within a track section with length L . Therefore, with T_{ref} as the reference time period for the noise assessment (e.g. 12 hours, 4 hours, 8 hours), the directional sound power per unit length on that track section is defined by:

$$L_{W',eq,line,i}(\psi,\varphi) = L_{W,0,dir,i}(\psi,\varphi) + 10 \times \lg\left(\frac{T_{idle}}{T_{ref}L}\right) \quad (\text{for } c = 2) \quad (2.3.4)$$

In general, directional sound power is obtained from each specific source as:

$$L_{W,0,dir,i}(\psi,\varphi) = L_{W,0,i} + \Delta L_{W,dir,vert,i} + \Delta L_{W,dir,hor,i} \quad (2.3.5)$$

where

- $\Delta L_{W,dir,vert,i}$ is the vertical directivity correction (dimensionless) function of ψ (Figure [2.3.b])
- $\Delta L_{W,dir,hor,i}$ is the horizontal directivity correction (dimensionless) function of φ (Figure [2.3.b]).

And where $L_{W,0,dir,i(\psi,\varphi)}$ shall, after being derived in 1/3 octave bands, be expressed in octave bands by energetically adding each pertaining 1/3 octave band together into the corresponding octave band.

Figure [2.3.b]

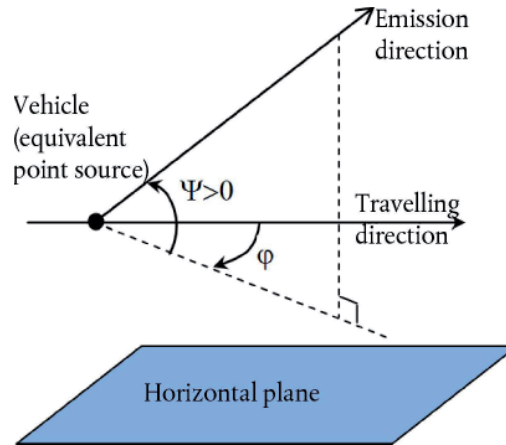
Geometrical definition

For the purpose of the calculations, the source strength is then specifically expressed in terms of directional sound power per 1 m length of track $L_{W',tot,dir,i}$ to account for the directivity of the sources in their vertical and horizontal direction, by means of the additional corrections.

Several $L_{W,0,dir,i}(\psi,\varphi)$ are considered for each vehicle-track-speed-running condition combination:

- for a 1/3 octave frequency band (*i*)
- for each track section (*j*)
- source height (*h*) (for sources at 0,5 m $h = 1$, at 4,0 m $h = 2$)
- directivity (*d*) of the source

A set of $L_{W,0,dir,i}(\psi,\varphi)$ are considered for each vehicle-track-speed-running condition combination, each track section, the heights corresponding to $h = 1$ and $h = 2$ and the directivity.

Rolling noise

The vehicle contribution and the track contribution to rolling noise are separated into four essential elements: wheel roughness, rail roughness, vehicle transfer function to the wheels and to the superstructure (vessels) and track transfer function. Wheel and rail roughness represent the cause of the excitation of the vibration at the contact point between the rail and the wheel, and the transfer functions are two empirical or modelled functions that represent the entire complex phenomena of the mechanical vibration and sound generation on the surfaces of the wheel, the rail, the sleeper and the track substructure. This separation reflects the physical evidence that roughness present on a rail may excite the vibration of the rail, but it will also excite the vibration of the wheel and vice versa. Not including one of these four parameters would prevent the decoupling of the classification of tracks and trains.

Wheel and rail roughness

Rolling noise is mainly excited by rail and wheel roughness in the wavelength range from 5-500 mm.

Definition

The roughness level L_r is defined as 10 times the logarithm to the base 10 of the square of the mean square value r^2 of the roughness of the running surface of a rail or a wheel in the direction of motion (longitudinal level) measured in μm over a certain rail length or the entire wheel diameter, divided by the square of the reference value r_0^2 :

$$L_r = 10 \times \lg \left(\frac{r}{r_0} \right)^2 \text{ dB} \quad (2.3.6)$$

where

$$r_0 = 1 \mu\text{m}$$

r = r.m.s. of the vertical displacement difference of the contact surface to the mean level

The roughness level L_r is typically obtained as a spectrum of wavelength λ and it shall be converted to a frequency spectrum $f = v/\lambda$, where f is the centre band frequency of a given 1/3 octave band in Hz, λ is the wavelength in m, and v is the train speed in km/h. The roughness spectrum as a function of frequency shifts along the frequency axis for different speeds. In general cases, after conversion to the frequency spectrum by means of the speed, it is necessary to obtain new 1/3 octave band spectra values averaging between two corresponding 1/3 octave bands in the wavelength domain. To estimate the total effective roughness frequency spectrum corresponding to the appropriate train speed, the two corresponding 1/3 octave bands defined in the wavelength domain shall be averaged energetically and proportionally.

The rail roughness level (track side roughness) for the i -th wave-number band is defined as $L_{r,TR,i}$

By analogy, **the wheel roughness level** (vehicle side roughness) for the i -th wave-number band is defined as $L_{r,VEH,i}$.

The total and effective roughness level for wave-number band i ($L_{R,tot,i}$) is defined as the energy sum of the roughness levels of the rail and that of the wheel plus the $A3(\lambda)$ contact filter to take into account the filtering effect of the contact patch between the rail and the wheel, and is in dB:

$$L_{R,TOT,i} = 10 \cdot \lg(10^{L_{r,TR,i}/10} + 10^{L_{r,VEH,i}/10}) + A_{3,i} \quad (2.3.7)$$

where expressed as a function of the i -th wave-number band corresponding to the wavelength λ .

The contact filter depends on the rail and wheel type and the load.

The total effective roughness for the j -th track section and each t -th vehicle type at its corresponding v speed shall be used in the method.

Vehicle, track and superstructure transfer function

Three speed-independent transfer functions, $L_{H,TR,i}$, $L_{H,VEH,i}$ and $L_{H,VEH,SUP,P}$ are defined: the first for each j -th track section and the second two for each t -th vehicle type. They relate the total effective roughness level with the sound power of the track, the wheels and the superstructure respectively.

The superstructure contribution is considered only for freight wagons, therefore only for vehicle type 'a'.

For rolling noise, therefore, the contributions from the track and from the vehicle are fully described by these transfer functions and by the total effective roughness level. When a train is idling, rolling noise shall be excluded.

For sound power per vehicle the rolling noise is calculated at axle height, and has as an input the total effective roughness level $L_{R,TOT,i}$ as a function of the vehicle speed v , the track, vehicle and superstructure transfer functions $L_{H,TR,i}$, $L_{H,VEH,i}$ and $L_{H,VEH,SUP,i}$ and the total number of axles N_a :

for $h = 1$:

$$L_{W,0,TR,i} = L_{R,TOT,i} + L_{H,TR,i} + 10 \times \lg(N_a) \quad \text{dB} \quad (2.3.8)$$

$$L_{W,0,VEH,i} = L_{R,TOT,i} + L_{H,VEH,i} + 10 \times \lg(N_a) \quad \text{dB} \quad (2.3.9)$$

$$L_{W,0,VEHSUP,i} = L_{R,TOT,i} + L_{H,VEHSUP,i} + 10 \times \lg(N_a) \quad \text{dB} \quad (2.3.10)$$

where N_a is the number of axles per vehicle for the t -th vehicle type.

Figure [2.3.c]

Scheme of the use of the different roughness and transfer function definitions

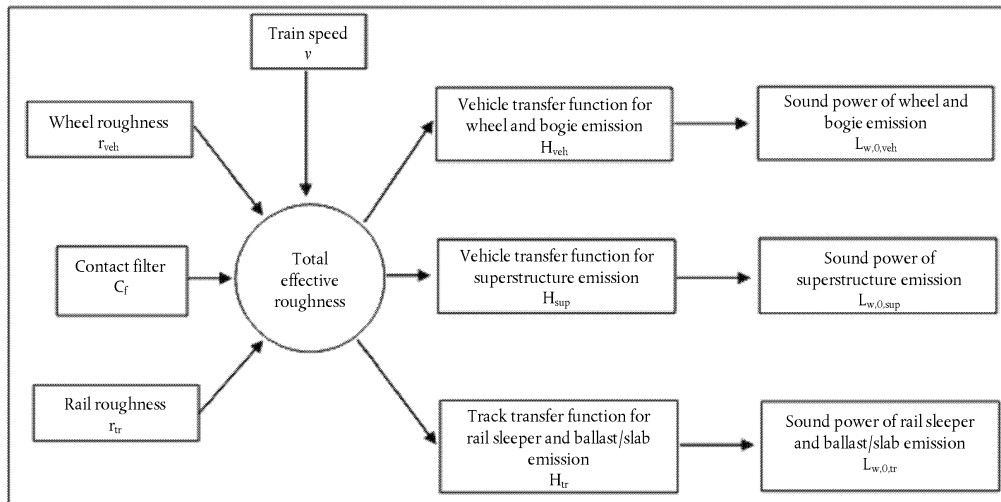

A minimum speed of 50 km/h (30 km/h only for trams and light metro) shall be used to determine the total effective roughness and therefore the sound power of the vehicles (this speed does not affect the vehicle flow calculation) to compensate for the potential error introduced by the simplification of rolling noise definition, braking noise definition and impact noise from crossings and switches definition.

Impact noise (crossings, switches and junctions)

Impact noise can be caused by crossings, switches and rail joints or points. It can vary in magnitude and can dominate rolling noise. Impact noise shall be considered for jointed tracks. For impact noise due to switches, crossings and joints in track sections with a speed of less than 50 km/h (30 km/h only for trams and light metro), since the minimum speed of 50 km/h (30 km/h only for trams and light metro) is used to include more effects according to the description of the rolling noise chapter, modelling shall be avoided. Impact noise modelling shall also be avoided under running condition $c = 2$ (idling).

Impact noise is included in the rolling noise term by (energy) adding a supplementary fictitious impact roughness level to the total effective roughness level on each specific j -th track section where it is present. In this case a new $L_{R,TOT+IMPACT,i}$ shall be used in place of $L_{R,TOT,i}$ and it will then become:

$$L_{R,TOT+IMPACT,i} = 10 \times \lg(10^{L_{R,TOT,i}/10} + 10^{L_{R,IMPACT,i}/10}) \quad \text{dB} \quad (2.3.11)$$

$L_{R,IMPACT,i}$ is a 1/3 octave band spectrum (as a function of frequency). To obtain this frequency spectrum, a spectrum is given as a function of wavelength λ and shall be converted to the required spectrum as a function of frequency using the relation $\lambda = v/f$, where f is the 1/3 octave band centre frequency in Hz and v is the s -th vehicle speed of the t -th vehicle type in km/h.

Impact noise will depend on the severity and number of impacts per unit length or joint density, so in the case where multiple impacts are given, the impact roughness level to be used in the equation above shall be calculated as follows:

$$L_{R,IMPACT,i} = L_{R,IMPACT-SINGLE,i} + 10 \times \lg\left(\frac{n_i}{0,01}\right) \quad \text{dB} \quad (2.3.12)$$

where $L_{R,IMPACT-SINGLE,i}$ is the impact roughness level as given for a single impact and n_i is the joint density.

The default impact roughness level is given for a joint density $n_i = 0,01 \text{ m}^{-1}$, which is one joint per each 100 m of track. Situations with different numbers of joints shall be approximated by adjusting the joint density n_i . It should be noted that when modelling the track layout and segmentation, the rail joint density shall be taken into account, i.e. it may be necessary to take a separate source segment for a stretch of track with more joints. The $L_{W,0}$ of track, wheel/bogie and superstructure contribution are incremented by means of the $L_{R,IMPACT,i}$ for ± 50 m before and after the rail joint. In the case of a series of joints, the increase is extended to between -50 m before the first joint and $+50$ m after the last joint.

The applicability of these sound power spectra shall normally be verified on-site.

For jointed tracks, a default n_i of 0,01 shall be used.

Squeal

Curve squeal is a special source that is only relevant for curves and is therefore localised. As it can be significant, an appropriate description is required. Curve squeal is generally dependent on curvature, friction conditions, train speed and track-wheel geometry and dynamics. The emission level to be used is determined for curves with radius below or equal to 500 m and for sharper curves and branch-outs of points with radii below 300 m. The noise emission should be specific to each type of rolling stock, as certain wheel and bogie types may be significantly less prone to squeal than others.

The applicability of these sound power spectra shall normally be verified on-site, especially for trams.

Taking a simple approach, squeal noise shall be considered by adding 8 dB for $R < 300$ m and 5 dB for $300 \text{ m} < R < 500$ m to the rolling noise sound power spectra for all frequencies. Squeal contribution shall be applied on railway track sections where the radius is within the ranges mentioned above for at least a 50 m length of track.

Traction noise

Although traction noise is generally specific to each characteristic operating condition amongst constant speed, deceleration, acceleration and idling, the only two conditions modelled are constant speed (that is valid as well when the train is decelerating or when it is accelerating) and idling. The source strength modelled only corresponds to maximum load conditions and this results in the quantities $L_{W,0,const,i} = L_{W,0,idling,i}$. Also, the $L_{W,0,idling,i}$ corresponds to the contribution of all physical sources of a given vehicle attributable to a specific height, as described in 2.3.1.

The $L_{W,0,idling,i}$ is expressed as a static noise source in the idling position, for the duration of the idling condition, and to be used modelled as a fixed point source as described in the following chapter for industrial noise. It shall be considered only if trains are idling for more than 0,5 hours.

These quantities can either be obtained from measurements of all sources at each operating condition, or the partial sources can be characterised individually, determining their parameter dependency and relative strength. This may be done by means of measurements on a stationary vehicle, by varying shaft speeds of the traction equipment, following ISO 3095:2005. As far as relevant, several traction noise sources have to be characterised which might not be all directly depending on the train speed:

- noise from the power train, such as diesel engines (including inlet, exhaust and engine block), gear transmission, electrical generators, mainly dependent on engine round per minute speed (rpm), and electrical sources such as converters, which may be mostly load-dependent,
- noise from fans and cooling systems, depending on fan rpm; in some cases fans can be directly coupled to the driveline,
- intermittent sources such as compressors, valves and others with a characteristic duration of operation and corresponding duty cycle correction for the noise emission.

As each of these sources can behave differently at each operating condition, the traction noise shall be specified accordingly. The source strength is obtained from measurements under controlled conditions. In general, locomotives will tend to show more variation in loading as the number of vehicles hauled and thereby the power output can vary significantly, whereas fixed train formations such as electric motored units (EMUs), diesel motored units (DMUs) and high-speed trains have a better defined load.

There is no a priori attribution of the source sound power to the source heights, and this choice shall depend on the specific noise and vehicle assessed. It shall be modelled to be at source A ($h = 1$) and at source B ($h = 2$).

Aerodynamic noise

Aerodynamic noise is only relevant at high speeds above 200 km/h and therefore it should first be verified whether it is actually necessary for application purposes. If the rolling noise roughness and transfer functions are known, it can be extrapolated to higher speeds and a comparison can be made with existing high-speed data to check whether higher levels are produced by aerodynamic noise. If train speeds on a network are above 200 km/h but limited to 250 km/h, in some cases it may not be necessary to include aerodynamic noise, depending on the vehicle design.

The aerodynamic noise contribution is given as a function of speed:

$$L_{W,0,i} = L_{W,0,1,i}(v_0) + \alpha_{1,i} \times \lg\left(\frac{v}{v_0}\right) \quad \text{dB} \quad \text{For } h = 1 \quad (2.3.13)$$

$$L_{W,0,i} = L_{W,0,2,i}(v_0) + \alpha_{2,i} \times \lg\left(\frac{v}{v_0}\right) \quad \text{dB} \quad \text{For } h = 2 \quad (2.3.14)$$

where

v_0 is a speed at which aerodynamic noise is dominant and is fixed at 300 km/h

$L_{W,0,1,i}$ is a reference sound power determined from two or more measurement points, for sources at known source heights, for example the first bogie

$L_{W,0,2,i}$ is a reference sound power determined from two or more measurement points, for sources at known source heights, for example the pantograph recess heights

$\alpha_{1,i}$ is a coefficient determined from two or more measurement points, for sources at known source heights, for example the first bogie

$\alpha_{2,i}$ is a coefficient determined from two or more measurement points, for sources at known source heights, for example the pantograph recess heights.

Source directivity

The horizontal directivity $\Delta L_{W,dir,hor,i}$ in dB is given in the horizontal plane and by default can be assumed to be a dipole for rolling, impact (rail joints etc.), squeal, braking, fans and aerodynamic effects, given for each i -th frequency band by:

$$\Delta L_{W,dir,hor,i} = 10 \times \lg(0,01 + 0,99 \cdot \sin^2\varphi) \quad (2.3.15)$$

The vertical directivity $\Delta L_{W,dir,ver,i}$ in dB is given in the vertical plane for source A ($h = 1$), as a function of the centre band frequency $f_{c,i}$ of each i -th frequency band, and for $-\pi/2 < \psi < \pi/2$ by:

$$\Delta L_{W,dir,ver,i} = \left(\left| \frac{40}{3} \times \left[\frac{2}{3} \times \sin(2 \cdot \psi) - \sin\psi \right] \times \lg \left[\frac{f_{c,i} + 600}{200} \right] \right| \right) \quad (2.3.16)$$

For source B ($h = 2$) for the aerodynamic effect:

$$\Delta L_{W,dir,ver,i} = 10 \times \lg(\cos^2\psi) \quad \text{for } \psi < 0 \quad (2.3.17)$$

$\Delta L_{W,dir,ver,i} = 0$ elsewhere

Directivity $\Delta L_{dir,ver,i}$ is not considered for source B ($h = 2$) for other effects, as omni-directionality is assumed for these sources in this position.

2.3.3. Additional effects

Correction for structural radiation (bridges and viaducts)

In the case where the track section is on a bridge, it is necessary to consider the additional noise generated by the vibration of the bridge as a result of the excitation caused by the presence of the train. Because it is not simple to model the bridge emission as an additional source, given the complex shapes of bridges, an increase in the rolling noise is used to account for the bridge noise. The increase shall be modelled exclusively by adding a fixed increase in the noise sound power per each third octave band. The sound power of only the rolling noise is modified when considering the correction and the new $L_{W,0,rolling-and-bridge,i}$ shall be used instead of $L_{W,0,rolling-only,i}$:

$$L_{W,0,rolling-and-bridge,i} = L_{W,0,rolling-only,i} + C_{bridge} \quad \text{dB} \quad (2.3.18)$$

where C_{bridge} is a constant that depends on the bridge type, and $L_{W,0,rolling-only,i}$ is the rolling noise sound power on the given bridge that depends only on the vehicle and track properties.

Correction for other railway-related noise sources

Various sources like depots, loading/unloading areas, stations, bells, station loudspeakers, etc. can be present and are associated with the railway noise. These sources are to be treated as industrial noise sources (fixed noise sources) and shall be modelled, if relevant, according to the following chapter for industrial noise.

2.4. Industrial noise

2.4.1. Source description

Classification of source types (point, line, area)

The industrial sources are of very variable dimensions. They can be large industrial plants as well as small concentrated sources like small tools or operating machines used in factories. Therefore, it is necessary to use an appropriate modelling technique for the specific source under assessment. Depending on the dimensions and the way several single sources extend over an area, with each belonging to the same industrial site, these may be modelled as point sources, source lines or area sources. In practice, the calculations of the noise effect are always based on point sources, but several point sources can be used to represent a real complex source, which mainly extends over a line or an area.

Number and position of equivalent sound sources

The real sound sources are modelled by means of equivalent sound sources represented by one or more point sources so that the total sound power of the real source corresponds to the sum of the single sound powers attributed to the different point sources.

The general rules to be applied in defining the number of point sources to be used are:

- line or surface sources where the largest dimension is less than 1/2 of the distance between the source and the receiver can be modelled as single point sources,
- sources where the largest dimension is more than 1/2 of the distance between the source and the receiver should be modelled as a series of incoherent point sources in a line or as a series of incoherent point sources over an area, such that for each of these sources the condition of 1/2 is fulfilled. The distribution over an area can include vertical distribution of point sources,
- for sources where the largest dimensions in height are over 2 m or near the ground, special care should be administered to the height of the source. Doubling the number of sources, redistributing them only in the z-component, may not lead to a significantly better result for this source,
- in the case of any source, doubling the number of sources over the source area (in all dimensions) may not lead to a significantly better result.

The position of the equivalent sound sources cannot be fixed, given the large number of configurations that an industrial site can have. Best practices will normally apply.

Sound power emission

General

The following information constitutes the complete set of input data for sound propagation calculations with the methods to be used for noise mapping:

- Emitted sound power level spectrum in octave bands
- Working hours (day, evening, night, on a yearly averaged basis)
- Location (coordinates x , y) and elevation (z) of the noise source
- Type of source (point, line, area)
- Dimensions and orientation
- Operating conditions of the source
- Directivity of the source.

The point, line and area source sound power are required to be defined as:

- For a point source, sound power L_w and directivity as a function of the three orthogonal coordinates (x , y , z);
- Two types of source lines can be defined:
 - source lines representing conveyor belts, pipe lines, etc., sound power per metre length L_w and directivity as a function of the two orthogonal coordinates to the axis of the source line,

- source lines representing moving vehicles, each associated with sound power L_w and directivity as a function of the two orthogonal coordinates to the axis of the source line and sound power per metre L_w derived by means of the speed and number of vehicles travelling along this line during day, evening and night; The correction for the working hours, to be added to the source sound power to define the corrected sound power that is to be used for calculations over each time period, C_w in dB is calculated as follows:

$$C_w = -10 \lg \left(\frac{l \times n}{1\,000 \times V \times T_0} \right) \quad (2.4.1)$$

Where:

V Speed of the vehicle [km/h];

n Number of vehicles passages per period [-];

l Total length of the source [m].

- For an area source, sound power per square metre L_{w/m^2} , and no directivity (may be horizontal or vertical).

The working hours are an essential input for the calculation of noise levels. The working hours shall be given for the day, evening and night period and, if the propagation is using different meteorological classes defined during each of the day, night and evening periods, then a finer distribution of the working hours shall be given in sub-periods matching the distribution of meteorological classes. This information shall be based on a yearly average.

The correction for the working hours, to be added to the source sound power to define the corrected sound power that shall be used for calculations over each time period, C_w in dB is calculated as follows:

$$C_w = 10 \times \lg \left(\frac{T}{T_{ref}} \right) \quad (2.4.2)$$

where

T is the active source time per period based on a yearly averaged situation, in hours;

T_{ref} is the reference period of time in hours (e.g. day is 12 hours, evening is 4 hours, night is 8 hours).

For the more dominant sources, the yearly average working hours correction shall be estimated at least within 0,5 dB tolerance in order to achieve an acceptable accuracy (this is equivalent to an uncertainty of less than 10 % in the definition of the active period of the source).

Source directivity

The source directivity is strongly related to the position of the equivalent sound source next to nearby surfaces. Because the propagation method considers the reflection of the nearby surface as well its sound absorption, it is necessary to consider carefully the location of the nearby surfaces. In general, these two cases will always be distinguished:

- a source sound power and directivity is determined and given relative to a certain real source when this is in free field (excluding the terrain effect). This is in agreement with the definitions concerning the propagation, if it is assumed that there is no nearby surface less than 0,01 m from the source and surfaces at 0,01 m or more are included in the calculation of the propagation,

- a source sound power and directivity is determined and given relative to a certain real source when this is placed in a specific location and therefore the source sound power and directivity is in fact an 'equivalent' one, since it includes the modelling of the effect of the nearby surfaces. This is defined in 'semi-free field' according to the definitions concerning the propagation. In this case, the nearby surfaces modelled shall be excluded from the calculation of propagation.

The directivity shall be expressed in the calculation as a factor $\Delta L_{w,dir,xyz}(x, y, z)$ to be added to the sound power to obtain the right directional sound power of a reference sound source seen by the sound propagation in the direction given. The factor can be given as a function of the direction vector defined by (x,y,z) with $\sqrt{x^2 + y^2 + z^2} = 1$. This directivity can also be expressed by means of other coordinate systems such as angular coordinate systems.

2.5. Calculation of noise propagation for road, railway, industrial sources.

2.5.1. Scope and applicability of the method

This document specifies a method for calculating the attenuation of noise during its outdoor propagation. Knowing the characteristics of the source, this method predicts the equivalent continuous sound pressure level at a receiver point corresponding to two particular types of atmospheric conditions:

- downward-refraction propagation conditions (positive vertical gradient of effective sound celerity) from the source to the receiver,
- homogeneous atmospheric conditions (null vertical gradient of effective sound celerity) over the entire area of propagation.

The method of calculation described in this document applies to industrial infrastructures and land transport infrastructures. It therefore applies in particular to road and railway infrastructures. Aircraft transport is included in the scope of the method only for the noise produced during ground operations and excludes take-off and landing.

Industrial infrastructures that emit impulsive or strong tonal noises as described in ISO 1996-2:2007 do not fall within the scope of this method.

The method of calculation does not provide results in upward-refraction propagation conditions (negative vertical gradient of effective sound speed) but these conditions are approximated by homogeneous conditions when computing L_{den} .

To calculate the attenuation due to atmospheric absorption in the case of transport infrastructure, the temperature and humidity conditions are calculated according to ISO 9613-1:1996.

The method provides results per octave band, from 63 Hz to 8 000 Hz. The calculations are made for each of the centre frequencies.

Partial covers and obstacles sloping, when modelled, more than 15° in relation to the vertical are out of the scope of this calculation method.

A single screen is calculated as a single diffraction calculation, two or more screens in a single path are treated as a subsequent set of single diffractions by applying the procedure described further.

2.5.2. Definitions used

All distances, heights, dimensions and altitudes used in this document are expressed in metres (m).

The notation MN stands for the distance in 3 dimensions (3D) between the points M and N , measured according to a straight line joining these points.

The notation \hat{MN} stands for the curved path length between the points M and N , in favourable conditions.

It is customary for real heights to be measured vertically in a direction perpendicular to the horizontal plane. Heights of points above the local ground are denoted h , absolute heights of points and absolute height of the ground are to be noted by the letter H .

To take into account the actual relief of the land along a propagation path, the notion of 'equivalent height' is introduced, to be noted by the letter z . This substitutes real heights in the ground effect equations.

The sound levels, noted by the capital letter L , are expressed in decibels (dB) per frequency band when index A is omitted. The sound levels in decibels dB(A) are given the index A.

The sum of the sound levels due to mutually incoherent sources is noted by the sign \oplus in accordance with the following definition:

$$L_1 \oplus L_2 = 10 \cdot \lg \left[10^{L_1/10} + 10^{L_2/10} \right] \quad (2.5.1)$$

2.5.3. Geometrical considerations

Source segmentation

Real sources are described by a set of point sources or, in the case of railway traffic or road traffic, by incoherent source lines. The propagation method assumes that line or area sources have previously been split up to be represented by a series of equivalent point sources. This may have occurred as pre-processing of the source data, or may occur within the pathfinder component of the calculation software. The means by which this has occurred is outside the scope of the current methodology.

Propagation paths

The method operates on a geometrical model consisting of a set of connected ground and obstacles surfaces. A vertical propagation path is deployed on one or more vertical planes with respect to the horizontal plane. For trajectories including reflections onto vertical surfaces not orthogonal to the incident plane, another vertical plane is subsequently considered including the reflected part of the propagation path. In these cases, where more vertical planes are used to describe the entire trajectory from the source to the receiver, the vertical planes are then flattened, like an unfolding Chinese screen.

Significant heights above the ground

The equivalent heights are obtained from the mean ground plane between the source and the receiver. This replaces the actual ground with a fictitious plane representing the mean profile of the land.

Figure 2.5.a

Equivalent heights in relation to the ground

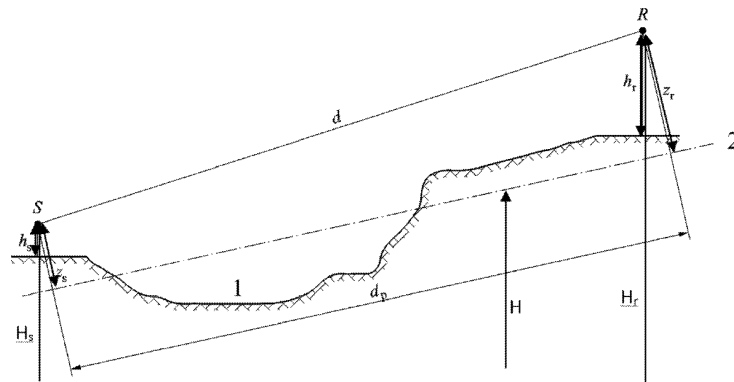

- 1: Actual relief
- 2: Mean plane

The equivalent height of a point is its orthogonal height in relation to the mean ground plane. The equivalent source height z_s and the equivalent receiver height z_r can therefore be defined. The distance between the source and receiver in projection over the mean ground plane is noted by d_p .

If the equivalent height of a point becomes negative, i.e. if the point is located below the mean ground plane, a null height is retained, and the equivalent point is then identical with its possible image.

Calculation of the mean plane

In the plane of the path, the topography (including terrain, mounds, embankments and other man-made obstacles, buildings, ...) may be described by an ordered set of discrete points (x_k, H_k) ; $k \in \{1, \dots, n\}$. This set of points defines a polyline, or equivalently, a sequence of straight segments $H_k = a_k x + b_k$, $x \in [x_k, x_{k+1}]$; $k \in \{1, \dots, n\}$, where:

$$\begin{cases} a_k = (H_{k+1} - H_k)/(x_{k+1} - x_k) \\ b_k = (H_k \cdot x_{k+1} - H_{k+1} \cdot x_k)/(x_{k+1} - x_k) \end{cases} \quad (2.5.2)$$

The mean plane is represented by the straight line $Z = ax + b$; $x \in [x_1, x_n]$, which is adjusted to the polyline by means of a least-square approximation. The equation of the mean line can be worked out analytically.

Using:

$$\begin{cases} A = \frac{2}{3} \sum_{k=1}^{n-1} a_k (x_{k+1}^3 - x_k^3) + \sum_{k=1}^{n-1} b_k (x_{k+1}^2 - x_k^2) \\ B = \sum_{k=1}^{n-1} a_k (x_{k+1}^2 - x_k^2) + 2 \sum_{k=1}^{n-1} b_k (x_{k+1} - x_k) \end{cases} \quad (2.5.3)$$

The coefficients of the straight line are given by:

$$\begin{cases} a = \frac{3(2A - B(x_n + x_1))}{(x_n - x_1)^3} \\ b = \frac{2(x_n^3 - x_1^3)}{(x_n - x_1)^4} B - \frac{3(x_n + x_1)}{(x_n - x_1)^3} A \end{cases} \quad (2.5.4)$$

Where segments with $x_{k+1} = x_k$ shall be ignored when evaluating eq. 2.5.3.

Reflections by building façades and other vertical obstacles

Contributions from reflections are taken into account by the introduction of image sources as described further.

2.5.4. Sound propagation model

For a receiver R the calculations are made according to the following steps:

- (1) on each propagation path:
 - calculation of the attenuation in favourable conditions,
 - calculation of the attenuation in homogeneous conditions,
 - calculation of the long-term sound level for each path;

- (2) accumulation of the long-term sound levels for all paths affecting a specific receiver, therefore allowing the total sound level to be calculated at the receiver point.

It should be noted that only the attenuations due to the ground effect (A_{ground}) and diffraction (A_{dif}) are affected by meteorological conditions.

2.5.5. Calculation process

For a point source S of directional sound power $L_{w,0,dir}$ and for a given frequency band, the equivalent continuous sound pressure level at a receiver point R in given atmospheric conditions is obtained according to the equations following below.

Sound level in favourable conditions (L_F) for a path (S,R)

$$L_F = L_{w,0,dir} - A_F \quad (2.5.5)$$

The term A_F represents the total attenuation along the propagation path in favourable conditions, and is broken down as follows:

$$L_F = A_{div} + A_{atm} + A_{boundary,F} \quad (2.5.6)$$

where

A_{div} is the attenuation due to geometrical divergence;

A_{atm} is the attenuation due to atmospheric absorption;

$A_{boundary,F}$ is the attenuation due to the boundary of the propagation medium in favourable conditions. It may contain the following terms:

$A_{ground,F}$ which is the attenuation due to the ground in favourable conditions;

$A_{dif,F}$ which is the attenuation due to diffraction in favourable conditions.

For a given path and frequency band, the following two scenarios are possible:

- either $A_{ground,F}$ is calculated with no diffraction ($A_{dif,F} = 0$ dB) and $A_{boundary,F} = A_{ground,F}$;
- or $A_{dif,F}$ is calculated. The ground effect is taken into account in the $A_{dif,F}$ equation itself ($A_{ground,F} = 0$ dB). This therefore gives $A_{boundary,F} = A_{dif,F}$.

Sound level in homogeneous conditions (L_H) for a path (S,R)

The procedure is strictly identical to the case of favourable conditions presented in the previous section.

$$L_H = L_{w,0,dir} - A_H \quad (2.5.7)$$

The term A_H represents the total attenuation along the propagation path in homogeneous conditions and is broken down as follows:

$$A_H = A_{div} + A_{atm} + A_{boundary,H} \quad (2.5.8)$$

where

A_{div} is the attenuation due to geometrical divergence;

A_{atm} is the attenuation due to atmospheric absorption;

$A_{boundary,H}$ is the attenuation due to the boundary of the propagation medium in homogeneous conditions. It may contain the following terms:

$A_{ground,H}$ which is the attenuation due to the ground in homogeneous conditions;

$A_{dif,H}$ which is the attenuation due to diffraction in homogeneous conditions.

For a given path and frequency band, the following two scenarios are possible:

- either $A_{ground,H}$ ($A_{dif,H} = 0$ dB) is calculated with no diffraction and $A_{boundary,H} = A_{ground,H}$;
- or $A_{dif,H}$ ($A_{ground,H} = 0$ dB) is calculated. The ground effect is taken into account in the $A_{dif,H}$ equation itself. This therefore gives $A_{boundary,H} = A_{dif,H}$

Statistical approach inside urban areas for a path (S,R)

Inside urban areas, a statistical approach to the calculation of the sound propagation behind the first line of buildings is also allowed, provided that such a method is duly documented, including relevant information on the quality of the method. This method may replace the calculation of the $A_{boundary,H}$ and $A_{boundary,F}$ by an approximation of the total attenuation for the direct path and all reflections. The calculation will be based on the average building density and the average height of all buildings in the area.

Long-term sound level for a path (S,R)

The 'long-term' sound level along a path starting from a given point source is obtained from the logarithmic sum of the weighted sound energy in homogeneous conditions and the sound energy in favourable conditions.

These sound levels are weighted by the mean occurrence p of favourable conditions in the direction of the path (S,R):

$$L_{LT} = 10 \times \lg \left(p \cdot 10^{\frac{L_F}{10}} + (1 - p) \cdot 10^{\frac{L_H}{10}} \right) \quad (2.5.9)$$

NB: The occurrence values for p are expressed in percentages. So for example, if the occurrence value is 82 %, equation (2.5.9) would have $p = 0,82$.

Long-term sound level at point R for all paths

The total long-term sound level at the receiver for a frequency band is obtained by energy summing contributions from all N paths, all types included:

$$L_{tot,LT} = 10 \times \lg \left(\sum_n 10^{\frac{L_{n,LT}}{10}} \right) \quad (2.5.10)$$

where

n is the index of the paths between S and R.

Taking reflections into account by means of image sources is described further. The percentage of occurrences of favourable conditions in the case of a path reflected on a vertical obstacle is taken to be identical to the occurrence of the direct path.

If S' is the image source of S , then the occurrence p' of the path (S',R) is taken to be equal to the occurrence p of the path (S,R) .

Long-term sound level at point R in decibels A (dBA)

The total sound level in decibels A (dBA) is obtained by summing levels in each frequency band:

$$L_{Aeq,LT} = 10 \times \lg \sum_i 10^{(L_{tot,LT,i} + AWC_{fi})/10} \quad (2.5.11)$$

where i is the index of the frequency band. AWC is the A-weighting correction according to the international standard IEC 61672-1:2003.

This level $L_{Aeq,LT}$ constitutes the final result, i.e. the long-term A-weighted sound pressure level at the receiver point on a specific reference time interval (e.g. day or evening, or night or a shorter time during day, evening or night).

2.5.6. Calculation of noise propagation for road, railway, industrial sources.

Geometrical divergence

The attenuation due to geometrical divergence, A_{div} , corresponds to a reduction in the sound level due to the propagation distance. For a point sound source in free field, the attenuation in dB is given by:

$$A_{div} = 20 \times \lg(d) + 11 \quad (2.5.12)$$

where d is the direct 3D slant distance between the source and the receiver.

Atmospheric absorption

The attenuation due to atmospheric absorption A_{atm} during propagation over a distance d is given in dB by the equation:

$$A_{atm} = \alpha_{atm} \cdot d/1000 \quad (2.5.13)$$

where

d is the direct 3D slant distance between the source and the receiver in m;

α_{atm} is the atmospheric attenuation coefficient in dB/km at the nominal centre frequency for each frequency band, in accordance with ISO 9613-1.

The values of the α_{atm} coefficient are given for a temperature of 15 °C, a relative humidity of 70 % and an atmospheric pressure of 101 325 Pa. They are calculated with the exact centre frequencies of the frequency band. These values comply with ISO 9613-1. Meteorological average over the long term shall be used if meteorological data is available.

Ground effect

The attenuation due to the ground effect is mainly the result of the interference between the reflected sound and the sound that is propagated directly from the source to the receiver. It is physically linked to the acoustic absorption of the ground above which the sound wave is propagated. However, it is also significantly dependent on atmospheric conditions during propagation, as ray bending modifies the height of the path above the ground and makes the ground effects and land located near the source more or less significant.

In case the propagation between the source and the receiver is affected by any obstacle in the propagation plane, the ground effect is calculated separately on the source and receiver side. In this case, z_s and z_r refer to the equivalent source and/or receiver position as indicated further where the calculation of the diffraction A_{diff} is presented.

Acoustic characterisation of ground

The acoustic absorption properties of the ground are mainly linked to its porosity. Compact ground is generally reflective and porous ground is absorbent.

For operational calculation requirements, the acoustic absorption of a ground is represented by a dimensionless coefficient G , between 0 and 1. G is independent of the frequency. Table 2.5.a gives the G values for the ground outdoors. In general, the average of the coefficient G over a path takes values between 0 and 1.

Table 2.5.a

G values for different types of ground

Description	Type	(kPa · s/m ²)	G value
Very soft (snow or moss-like)	A	12,5	1
Soft forest floor (short, dense heather-like or thick moss)	B	31,5	1
Uncompacted, loose ground (turf, grass, loose soil)	C	80	1
Normal uncompacted ground (forest floors, pasture field)	D	200	1
Compacted field and gravel (compacted lawns, park area)	E	500	0,7
Compacted dense ground (gravel road, car park)	F	2 000	0,3
Hard surfaces (most normal asphalt, concrete)	G	20 000	0
Very hard and dense surfaces (dense asphalt, concrete, water)	H	200 000	0

G_{path} is defined as the fraction of absorbent ground present over the entire path covered.

When the source and receiver are close-by so that $d_p \leq 30(z_s + z_r)$, the distinction between the type of ground located near the source and the type of ground located near the receiver is negligible. To take this comment into account, the ground factor G_{path} is therefore ultimately corrected as follows:

$$G'_{path} = \begin{cases} G_{path} \frac{d_p}{30(z_s + z_r)} + G_s \left(1 - \frac{d_p}{30(z_s + z_r)} \right) & \text{if } d_p \leq 30(z_s + z_r) \\ G_{path} & \text{otherwise} \end{cases} \quad (2.5.14)$$

where G_s is the ground factor of the source area. $G_s = 0$ for road platforms ⁽¹⁾, slab tracks. $G_s = 1$ for rail tracks on ballast. There is no general answer in the case of industrial sources and plants.

G may be linked to the flow resistivity.

Figure 2.5.b

Determination of the ground coefficient G_{path} over a propagation path

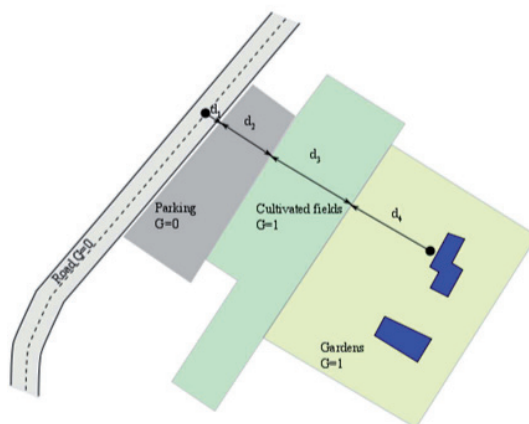

$$d_p = d_1 + d_2 + d_3 + d_4$$

$$G_{path} = (0 \cdot d_1 + 0 \cdot d_2 + 1 \cdot d_3 + 1 \cdot d_4) / d_p = (d_3 + d_4) / d_p$$

The following two subsections on calculations in homogeneous and favourable conditions introduce the generic \bar{G}_w and \bar{G}_m notations for the absorption of the ground. Table 2.5.b gives the correspondence between these notations and the G_{path} and G'_{path} variables.

Table 2.5.b

Correspondence between \bar{G}_w and \bar{G}_m and (G_{path} , G'_{path})

	Homogeneous conditions			Favourable conditions		
	A_{ground}	$\Delta_{ground(S,O)}$	$\Delta_{ground(O,R)}$	A_{ground}	$\Delta_{ground(S,O)}$	$\Delta_{ground(O,R)}$
\bar{G}_w	G'_{path}			G_{path}		
\bar{G}_m	G'_{path}			G_{path}	G'_{path}	G_{path}

⁽¹⁾ The absorption of porous road pavements is taken into account in the emission model.

Calculations in homogeneous conditions

The attenuation due to the ground effect in homogeneous conditions is calculated according to the following equations:

if $\bar{G}_{path} \neq 0$

$$A_{ground,H} = \max \left(-10 \times \lg \left[4 \frac{k^2}{d_p^2} \left(z_s^2 - \sqrt{\frac{2C_f}{k}} z_s + \frac{C_f}{k} \right) \left(z_r^2 - \sqrt{\frac{2C_f}{k}} z_r + \frac{C_f}{k} \right) \right], A_{ground,H,min} \right) \quad (2.5.15)$$

where

$$k = \frac{2\pi f_m}{c}$$

f_m is the nominal centre frequency of the frequency band considered, in Hz, c is the speed of the sound in the air, taken as equal to 340 m/s, and C_f is defined by:

$$C_f = d_p \frac{1 + 3w d_p e^{-\sqrt{w} d_p}}{1 + w d_p} \quad (2.5.16)$$

where the values of w are given by the equation below:

$$w = 0,0185 \frac{f_m^{2.5} \bar{G}_w^{-2.6}}{f_m^{1.5} \bar{G}_w^{-2.6} + 1,3 \cdot 10^3 f_m^{0.75} \bar{G}_w^{-1.3} + 1,16 \cdot 10^6} \quad (2.5.17)$$

\bar{G}_w may be equal to either G_{path} or G'_{path} depending on whether the ground effect is calculated with or without diffraction, and according to the nature of the ground under the source (real source or diffracted). This is specified in the following subsections and summarised in Table 2.5.b.

$$A_{ground,H,min} = -3(1 - \bar{G}_m) \quad (2.5.18)$$

is the lower bound of $A_{ground,H}$.

For a path (S_pR) in homogeneous conditions without diffraction:

$$\bar{G}_w = G'_{path}$$

$$\bar{G}_m = G'_{path}$$

With diffraction, refer to the section on diffraction for the definitions of \bar{G}_w and \bar{G}_m .

if $G_{path} = 0$: $A_{ground,H} = -3$ dB

The term $-3(1 - \bar{G}_m)$ takes into account the fact that when the source and the receiver are far apart, the first reflection source side is no longer on the platform but on natural land.

Calculation in favourable conditions

The ground effect in favourable conditions is calculated with the equation of $A_{ground,H}$ provided that the following modifications are made:

If $G_{path} \neq 0$

(a) In the equation of $A_{ground,H}$ the heights z_s and z_r are replaced by $z_s + \delta z_s + \delta z_T$ and $z_r + \delta z_r + \delta z_T$ respectively where

$$\begin{cases} \delta z_s = a_0 \left(\frac{z_s}{z_s + z_r} \right)^2 \frac{d_p^2}{2} \\ \delta z_r = a_0 \left(\frac{z_r}{z_s + z_r} \right)^2 \frac{d_p^2}{2} \end{cases} \quad (2.5.19)$$

$a_0 = 2 \times 10^{-4} \text{ m}^{-1}$ is the reverse of the radius of curvature

$$\delta z_T = 6 \cdot 10^{-3} \frac{d_p}{z_s + z_r}$$

(b) The lower bound of $A_{ground,F}$ depends on the geometry of the path:

$$A_{ground,F,\min} = \begin{cases} -3(1 - \overline{G}_m) & \text{if } d_p \leq 30(z_s + z_r) \\ -3(1 - \overline{G}_m) \cdot \left(1 + 2 \left(1 - \frac{30(z_s + z_r)}{d_p} \right) \right) & \text{otherwise} \end{cases} \quad (2.5.20)$$

If $G_{path} = 0$

$$A_{ground,F} = A_{ground,F,\min}$$

The height corrections δz_s and δz_r convey the effect of the sound ray bending. δz_T accounts for the effect of the turbulence.

\overline{G}_m may also be equal to either G_{path} or G'_{path} depending on whether the ground effect is calculated with or without diffraction, and according to the nature of the ground under the source (real source or diffracted). This is specified in the following subsections.

For a path (S,R) in favourable conditions without diffraction:

$$\overline{G}_w = G_{path} \text{ in equation (2.5.17);}$$

$$\overline{G}_m = G'_{path}$$

With diffraction, refer to the next section for the definitions of \overline{G}_w and \overline{G}_m .

Diffraction

As a general rule, the diffraction shall be studied at the top of each obstacle located on the propagation path. If the path passes 'high enough' over the diffraction edge, $A_{dif} = 0$ can be set and a direct view calculated, in particular by evaluating A_{ground} .

In practice, for each frequency band centre frequency, the path difference δ is compared with the quantity $-\lambda/20$. If an obstacle does not produce diffraction, this for instance being determined according to Rayleigh's criterion, there is no need to calculate A_{dif} for the frequency band considered. In other words, $A_{dif} = 0$ in this case. Otherwise, A_{dif} is calculated as described in the remainder of this part. This rule applies in both homogeneous and favourable conditions, for both single and multiple diffraction.

When, for a given frequency band, a calculation is made according to the procedure described in this section, A_{ground} is set as equal to 0 dB when calculating the total attenuation. The ground effect is taken into account directly in the general diffraction calculation equation.

The equations proposed here are used to process the diffraction on thin screens, thick screens, buildings, earth berms (natural or artificial), and by the edges of embankments, cuttings and viaducts.

When several diffracting obstacles are encountered on a propagation path, they are treated as a multiple diffraction by applying the procedure described in the following section on calculation of the path difference.

The procedures presented here are used to calculate the attenuations in both homogeneous conditions and favourable conditions. Ray bending is taken into account in the calculation of the path difference and to calculate the ground effects before and after diffraction.

General principles

Figure 2.5.c illustrates the general method of calculation of the attenuation due to diffraction. This method is based on breaking down the propagation path into two parts: the 'source side' path, located between the source and the diffraction point, and the 'receiver side' path, located between the diffraction point and the receiver.

The following are calculated:

- a ground effect, source side, $\Delta_{ground(S,O)}$
- a ground effect, receiver side, $\Delta_{ground(O,R)}$
- and three diffractions:
 - between the source S and the receiver R : $\Delta_{dif(S,R)}$
 - between the image source S' and R : $\Delta_{dif(S',R)}$
 - between S and the image receiver R' : $\Delta_{dif(S,R')}$.

Figure 2.5.c

Geometry of a calculation of the attenuation due to diffraction

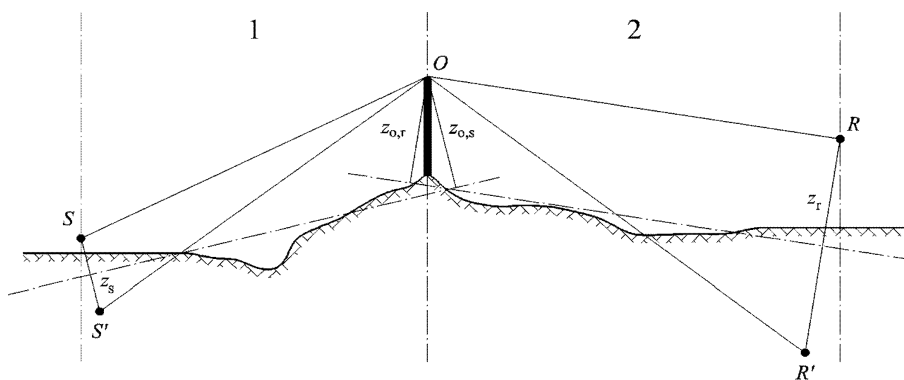

- 1: Source side
- 2: Receiver side

where

S is the source;

R is the receiver;

S' is the image source in relation to the mean ground plane source side;

R' is the image receiver in relation to the mean ground plane receiver side;

O is the diffraction point;

z_s is the equivalent height of the source S in relation to the mean plane source side;

$z_{o,s}$ is the equivalent height of the diffraction point O in relation to the mean ground plane source side;

z_r is the equivalent height of the receiver R in relation to the mean plane receiver side;

$z_{o,r}$ is the equivalent height of the diffraction point O in relation to the mean ground plane receiver side.

The irregularity of the ground between the source and the diffraction point, and between the diffraction point and the receiver, is taken into account by means of equivalent heights calculated in relation to the mean ground plane, source side first and receiver side second (two mean ground planes), according to the method described in the subsection on significant heights above the ground.

Pure diffraction

For pure diffraction, with no ground effects, the attenuation is given by:

$$\Delta_{dif} = \begin{cases} 10C_h \cdot \lg\left(3 + \frac{40}{\lambda} C''\delta\right) & \text{if } \frac{40}{\lambda} C''\delta \geq -2 \\ 0 & \text{otherwise} \end{cases} \quad (2.5.21)$$

where

$$C_h = 1 \quad (2.5.22)$$

λ is the wavelength at the nominal centre frequency of the frequency band considered;

δ is the path difference between the diffracted path and the direct path (see next subsection on calculation of the path difference);

C'' is a coefficient used to take into account multiple diffractions:

$C'' = 1$ for a single diffraction.

For a multiple diffraction, if e is the total distance along the path, O1 to O2 + O2 to O3 + O3 to O4 from the 'rubber band method', (see Figures 2.5.d and 2.5.f) and if e exceeds 0,3 m (otherwise $C'' = 1$), this coefficient is defined by:

$$C'' = \frac{1 + \left(\frac{5\lambda}{e}\right)^2}{\frac{1}{3} + \left(\frac{5\lambda}{e}\right)^2} \quad (2.5.23)$$

The values of Δ_{dif} shall be bound:

- if $\Delta_{dif} < 0$: $\Delta_{dif} = 0$ dB
- if $\Delta_{dif} > 25$: $\Delta_{dif} = 25$ dB for a diffraction on a horizontal edge and only on the term Δ_{dif} which figures in the calculation of A_{dif} . This upper bound shall not be applied in the Δ_{dif} terms that intervene in the calculation of Δ_{ground} , or for a diffraction on a vertical edge (lateral diffraction) in the case of industrial noise mapping.

Calculation of the path difference

The path difference δ is calculated in a vertical plane containing the source and the receiver. This is an approximation in relation to the Fermat principle. The approximation remains applicable here (source lines). The path difference δ is calculated as in the following Figures, based on the situations encountered.

Homogeneous conditions

Figure 2.5.d

Calculation of the path difference in homogeneous conditions. O , O_1 , and O_2 are the diffraction points

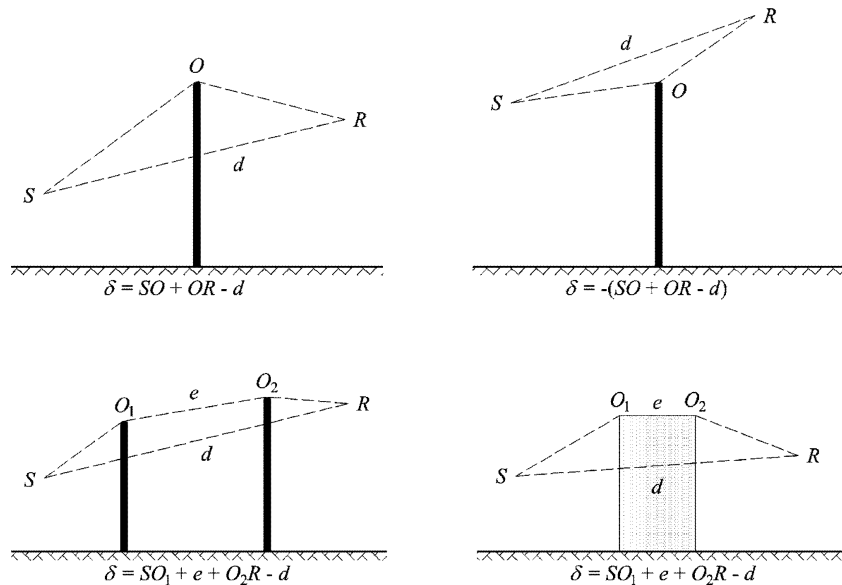

Note: For each configuration, the expression of δ is given.

Favourable conditions

Figure 2.5.e

Calculation of the path difference in favourable conditions (single diffraction)

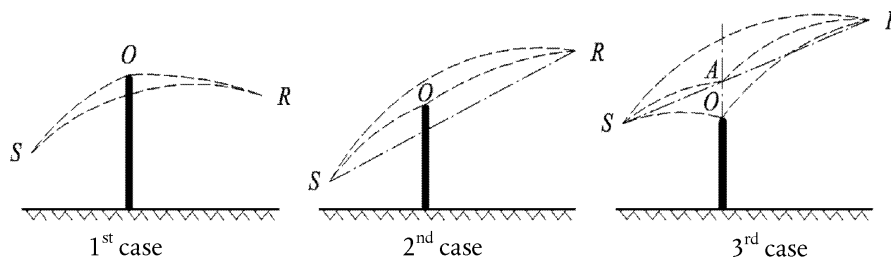

In favourable conditions, it is considered that the three curved sound rays SO , OR , and SR have an identical radius of curvature Γ defined by:

$$\Gamma = \max(1\ 000, 8d) \tag{2.5.24}$$

The length of a sound ray curve MN is noted \hat{MN} in favourable conditions. This length is equal to:

$$\hat{MN} = 2\Gamma \arcsin\left(\frac{MN}{2\Gamma}\right) \tag{2.5.25}$$

In principle, three scenarios should be considered in the calculation of the path difference in favourable conditions δ_F (see Figure 2.5.e). In practice, two equations are sufficient:

— if the straight sound ray SR is masked by the obstacle (1st and 2nd case in Figure 2.5.e):

$$\delta_F = \hat{SO} + \hat{OR} - \hat{SR} \tag{2.5.26}$$

— if the straight sound ray SR is not masked by the obstacle (3rd case in Figure 2.5.e):

$$\delta_F = 2\hat{SA} + 2\hat{AR} - \hat{SO} - \hat{OR} - \hat{SR} \tag{2.5.27}$$

where A is the intersection of the straight sound ray SR and the extension of the diffracting obstacle.

For the multiple diffractions in favourable conditions:

- determine the convex hull defined by the various potential diffraction edges;
- eliminate the diffraction edges which are not on the boundary of the convex hull;
- calculate δ_F based on the lengths of the curved sound ray, by breaking down the diffracted path into as many curved segments as necessary (see Figure 2.5.f)

$$\delta_F = \hat{SO}_1 + \sum_{i=1}^{i=n-1} O_i \hat{O}_{i+1} + \hat{O}_n R - \hat{SR} \tag{2.5.28}$$

Figure 2.5.f

Example of calculation of the path difference in favourable conditions, in the case of multiple diffractions

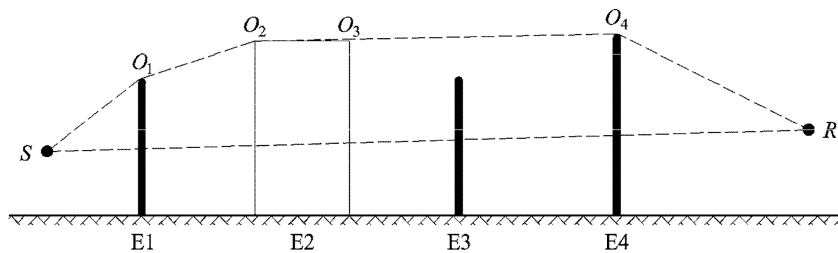

In the scenario presented in Figure 2.5.f, the path difference is:

$$\delta_F = \hat{S}O_1 + O_1\hat{O}_2 + O_2\hat{O}_3 + O_3\hat{O}_4 + \hat{O}_4R - \hat{S}R \quad (2.5.29)$$

Calculation of the attenuation A_{dif}

The attenuation due to diffraction, taking the ground effects on the source side and receiver side into account, is calculated according to the following general equations:

$$A_{dif} = \Delta_{dif(S,R)} + \Delta_{ground(S,O)} + \Delta_{ground(O,R)} \quad (2.5.30)$$

where

- $\Delta_{dif(S,R)}$ is the attenuation due to the diffraction between the source S and the receiver R
- $\Delta_{ground(S,O)}$ is the attenuation due to the ground effect on the source side, weighted by the diffraction on the source side; where it is understood that $O = O_1$ in case of multiple diffractions as in Figure 2.5.f
- $\Delta_{ground(O,R)}$ is the attenuation due to the ground effect on the receiver side, weighted by the diffraction on the receiver side (see the following subsection on calculation of the term $\Delta_{ground(O,R)}$).

Calculation of the term $\Delta_{ground(S,O)}$

$$\Delta_{ground(S,O)} = -20 \times \lg \left(1 + \left(10^{\frac{-A_{ground(S,O)}}{20}} - 1 \right) \cdot 10^{\frac{-(\Delta_{dif(S',R)} - \Delta_{dif(S,R)})}{20}} \right) \quad (2.5.31)$$

where

- $A_{ground(S,O)}$ is the attenuation due to the ground effect between the source S and the diffraction point O . This term is calculated as indicated in the previous subsection on calculations in homogeneous conditions and in the previous subsection on calculation in favourable conditions, with the following hypotheses:
 - $z_r = z_{o,s}$,
 - G_{path} is calculated between S and O ,
 - In homogeneous conditions: $\overline{G}_w = G'_{path}$ in equation (2.5.17), $\overline{G}_m = G'_{path}$ in equation (2.5.18),
 - In favourable conditions: $\overline{G}_w = G_{path}$ in equation (2.5.17), $\overline{G}_m = G'_{path}$ in equation (2.5.20),
 - $\Delta_{dif(S',R)}$ is the attenuation due to the diffraction between the image source S' and R , calculated as in the previous subsection on pure diffraction,
 - $\Delta_{dif(S,R)}$ is the attenuation due to the diffraction between S and R , calculated as in Subsection VI.4.4.b.

Calculation of the term $\Delta_{ground(O,R)}$

$$\Delta_{ground(O,R)} = -20 \times \lg \left(1 + \left(10^{\frac{-A_{ground(O,R)}}{20}} - 1 \right) \cdot 10^{\frac{(\Delta_{dif(S,R')} - \Delta_{dif(S,R)})}{20}} \right) \quad (2.5.32)$$

where

- $A_{ground(O,R)}$ is the attenuation due to the ground effect between the diffraction point O and the receiver R . This term is calculated as indicated in the previous subsection on calculation in homogeneous conditions and in the previous subsection on calculation in favourable conditions, with the following hypotheses:
 - $z_s = z_{o,r}$,
 - G_{path} is calculated between O and R .

The G'_{path} correction does not need to be taken into account here as the source considered is the diffraction point. Therefore, G_{path} shall indeed be used in the calculation of ground effects, including for the lower bound term of the equation which becomes $-3(1 - G_{path})$.

- In homogeneous conditions, $\overline{G}_w = G_{path}$ in equation (2.5.17) and $\overline{G}_m = G_{path}$ in equation (2.5.18);
- In favourable conditions, $\overline{G}_w = G_{path}$ in equation (2.5.17) and $\overline{G}_m = G_{path}$ in equation (2.5.20);
- $\Delta_{dif(S,R')}$ is the attenuation due to the diffraction between S and the image receiver R' , calculated as in the previous section on pure diffraction;
- $\Delta_{dif(S,R)}$ is the attenuation due to the diffraction between S and R , calculated as in the previous subsection on pure diffraction.

Vertical edge scenarios

Equation (2.5.21) may be used to calculate the diffractions on vertical edges (lateral diffractions) in case of industrial noise. If this is the case, $A_{dif} = \Delta_{dif(S,R)}$ is taken and the term A_{ground} is kept. In addition, A_{atm} and A_{ground} shall be calculated from the total length of the propagation path. A_{div} is still calculated from the direct distance d . Equations (2.5.8) and (2.5.6) respectively become:

$$A_H = A_{div} + A_{atm}^{path} + A_{ground,H}^{path} + \Delta_{dif,H(S,R)} \quad (2.5.33)$$

$$A_F = A_{div} + A_{atm}^{path} + A_{ground,F}^{path} + \Delta_{dif,H(S,R)} \quad (2.5.34)$$

Δ_{dif} is indeed used in homogeneous conditions in equation (2.5.34).

Reflections on vertical obstacles

Attenuation through absorption

The reflections on vertical obstacles are dealt with by means of image sources. Reflections on building façades and noise barriers are thus treated in this way.

An obstacle is considered to be vertical if its slope in relation to the vertical is less than 15°.

When dealing with reflections on objects which slope in relation to the vertical is more or equal to 15° the object is not considered.

The obstacles where at least one dimension is less than 0,5 m shall be ignored in the reflection calculation, except for special configurations ⁽¹⁾.

Note that reflections on the ground are not dealt with here. They are taken into account in the calculations of attenuation due to the boundary (ground, diffraction).

If L_{WS} is the power level of the source S and α_r the absorption coefficient of the surface of the obstacle as defined by the EN 1793-1:2013, then the power level of the image source S' is equal to:

$$L_{WS'} = L_{WS} + 10 \cdot \lg(1 - \alpha_r) = L_{WS} + A_{regl} \quad (2.5.35)$$

where $0 \leq \alpha_r < 1$

⁽¹⁾ A network of small obstacles in a plane and at regular intervals constitutes one example of a special configuration.

The propagation attenuations described above are then applied to this path (image source, receiver), as for a direct path.

Figure 2.5.g

Specular reflection on an obstacle dealt with by the image source method (S: source, S': image source, R: receiver)

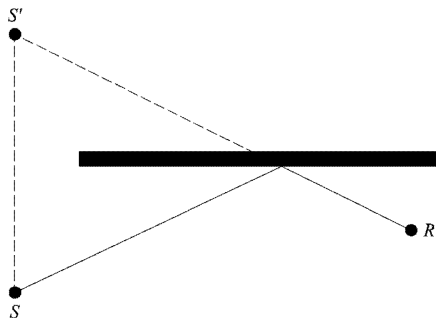

Attenuation through retrodiffraction

In the geometrical research of sound paths, during reflection on a vertical obstacle (barrier wall, building), the position of the impact of the ray in relation to the upper edge of this obstacle determines the more or less significant proportion of energy effectively reflected. This loss of acoustic energy when the ray undergoes a reflection is called attenuation through retrodiffraction.

In the case of potential multiple reflections between two vertical walls, at least the first reflection shall be considered.

In the case of a trench (see for example Figure 2.5.h), the attenuation through retrodiffraction shall be applied to each reflection on the retaining walls.

Figure 2.5.h

Sound ray reflected to the order of 4 in a track in a trench: actual cross-section (top), unfolded cross-section (bottom)

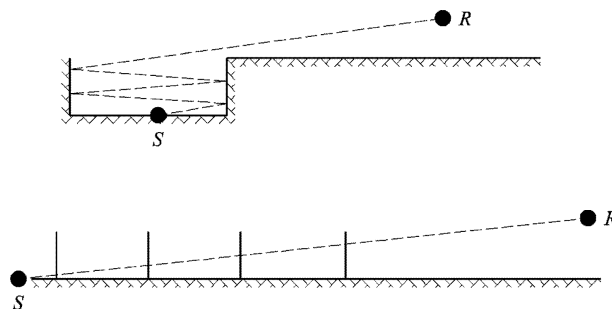

In this representation, the sound ray reaches the receiver 'by successively passing through' the retaining walls of the trench, which can therefore be compared to openings.

When calculating propagation through an opening, the sound field at the receiver is the sum of the direct field and the field diffracted by the edges of the opening. This diffracted field ensures the continuity of the transition between the clear area and the shadow area. When the ray approaches the edge of the opening, the direct field is attenuated. The calculation is identical to that of the attenuation by a barrier in the clear area.

The path difference δ' associated with each retrodiffraction is the opposite of the path difference between S and R relatively at each upper edge O, and this in a view according to a deployed cross-section (see Figure 2.5.i).

$$\delta' = -(SO + OR - SR) \tag{2.5.36}$$

Figure 2.5.i

The path difference for the second reflection

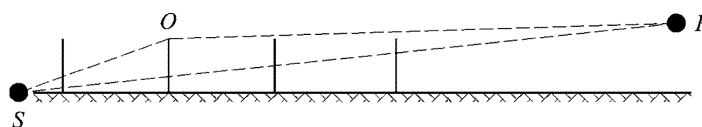

The 'minus' sign of equation (2.5.36) means that the receiver is considered here in the clear area.

Attenuation through retrodiffraction $\Delta_{retrodif}$ is obtained by equation (2.5.37), which is similar to equation (2.5.21) with reworked notations.

$$\Delta_{retrodif} = \begin{cases} 10C_h \cdot \lg\left(3 + \frac{40}{\lambda} \delta'\right) & \text{if } \frac{40}{\lambda} \delta' \geq -2 \\ 0 & \text{otherwise} \end{cases} \tag{2.5.37}$$

This attenuation is applied to the direct ray each time it 'passes through' (reflects on) a wall or building. The power level of the image source S' therefore becomes:

$$L_{W'} = L_W + 10 \times \lg(1 - \alpha) - \Delta_{retrodif} \tag{2.5.38}$$

In complex propagation configurations, diffractions may exist between reflections, or between the receiver and the reflections. In this case, the retrodiffraction by the walls is estimated by considering the path between source and first diffraction point R' (therefore considered as the receiver in equation (2.5.36)). This principle is illustrated in Figure 2.5.j.

Figure 2.5.j

The path difference in the presence of a diffraction: actual cross-section (top), unfolded cross-section (bottom)

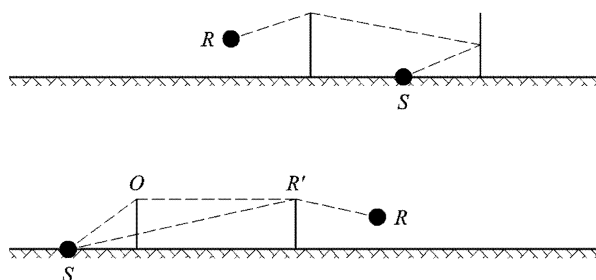

In case of multiple reflections the reflections due to every single reflections are added.

2.6. General provisions — Aircraft noise

2.6.1. Definitions and symbols

Some important *terms* are described here by the general meanings attributed to them in this document. The list is not exhaustive; only expressions and acronyms used frequently are included. Others are described where they first occur.

The mathematical *symbols* (listed after the terms) are the main ones used in equations in the main text. Other symbols used locally in both the text and the appendices are defined where they are used.

The reader is reminded periodically of the interchangeability of the words *sound* and *noise* in this document. Although the word *noise* has subjective connotations — it is usually defined by acousticians as ‘unwanted sound’ — in the field of aircraft noise control it is commonly taken to mean just sound — airborne energy transmitted by acoustic wave motion. The symbol → denotes cross references to other terms included in the list.

Terms

AIP	Aeronautical Information Publication
Aircraft configuration	The positions of slats, flaps and landing gear
Aircraft movement	An arrival, departure or other aircraft action that affects noise exposure around an aerodrome
Aircraft noise and performance data	Data describing the acoustic and performance characteristics of different aeroplanes types that are required by the modelling process. They include → <i>NPD relationships</i> and information that allows engine thrust/power to be calculated as a function of → <i>flight configuration</i> . The data are usually supplied by the aircraft manufacturer although when that is not possible it is sometimes obtained from other sources. When no data are available, it is usual to represent the aircraft concerned by adapting data for a suitably similar aircraft — this is referred to as <i>substitution</i>
Altitude	Height above mean sea level
ANP database	The Aircraft Noise and Performance database included in Appendix I
A-weighted sound level, L_A	Basic sound/noise level scale used for measuring environmental noise including that from aircraft and on which most noise contour metrics are based
Backbone ground track	A representative or nominal ground track which defines the centre of a swathe of tracks
Baseline noise event level	The noise event level read from an NPD database
Brake release	→ <i>Start of roll</i>
Corrected net thrust	At a given power setting (e.g. <i>EPR</i> or N_1) net thrust falls with air density and thus with increasing aircraft altitude; corrected net thrust is the value at sea level
Cumulative sound/noise level	A decibel measure of the noise received over a specified period of time, at a point near an airport, from aeroplane traffic using normal operating conditions and flight paths. It is calculated by accumulating in some way the event sound/noise levels occurring at that point
Decibel sum or average	Sometimes referred to elsewhere as ‘energy’ or ‘logarithmic’ (as opposed to arithmetic) values. Used when it is appropriate to sum or average the underlying energy-like quantities; e.g. $decibel\ sum = 10 \cdot \lg \sum 10^{L_i/10}$

Energy fraction, F	Ratio of sound energy received from segment to energy received from infinite flight path
Engine power setting	Value of the \rightarrow <i>noise related power parameter</i> used to determine noise emission from the NPD database
Equivalent (continuous) sound level, L_{eq}	A measure of long-term sound. The level of a hypothetical steady sound, which over a specified period of time, contains the same total energy as the actual variable sound
Event sound/noise level	A decibel measure of the finite quantity of sound (or noise) received from a passing aeroplane \rightarrow <i>sound exposure level</i>
Flight configuration	= \rightarrow <i>Aircraft configuration</i> + \rightarrow <i>Flight parameters</i>
Flight parameters	Aircraft power setting, speed, bank angle and weight
Flight path	The path of an aeroplane through the air, defined in three dimensions, usually with reference to an origin at the start of take-off roll or at the landing threshold
Flight path segment	Part of an aircraft flight path represented for noise modelling purposes by a straight line of finite length
Flight procedure	The sequence of operational steps followed by the aircraft crew or flight management system: expressed as changes of flight configuration as a function of distance along the ground track
Flight profile	Variation of aeroplane height along the ground track (sometimes includes changes of \rightarrow <i>flight configuration</i> too) — described by a set of \rightarrow <i>profile points</i>
Ground plane	(Or Nominal Ground Plane) Horizontal ground surface through the aerodrome reference point on which the contours are normally calculated
Ground speed	Aircraft speed relative to a fixed point on the ground
Ground track	Vertical projection of the flight path onto the ground plane
Height	Vertical distance between aircraft and \rightarrow <i>ground plane</i>
Integrated sound level	Otherwise termed \rightarrow <i>single event sound exposure level</i>
ISA	International Standard Atmosphere — defined by ICAO. Defines variation of air temperature, pressure, and density with height above mean sea level. Used to normalise the results of aircraft design calculations and analysis of test data
Lateral attenuation	Excess attenuation of sound with distance attributable, directly or indirectly, to the presence of the ground surface. Significant at low angles of elevation (of the aircraft above the ground plane)
Maximum noise/sound level	The maximum sound level reached during an event
Mean Sea Level, MSL	The standard earth surface elevation to which the \rightarrow ISA is referred
Net thrust	The propulsive force exerted by an engine on the airframe

Noise	Noise is defined as unwanted sound. But metrics such as <i>A-weighted sound level</i> (L_A) and <i>effective perceived noise level</i> (EPNL) effectively convert sound levels into noise levels. Despite a consequent lack of rigour, the terms sound and noise are sometimes used interchangeably in this document, as elsewhere — especially in conjunction with the word <i>level</i>
Noise contour	A line of constant value of a cumulative aircraft noise level or index around an airport
Noise impact	The adverse effect(s) of noise on its recipients; importantly it is implied that noise metrics are indicators of noise impact
Noise index	A measure of long term, or cumulative sound which correlates with (i.e. is considered to be a predictor of) its effects on people. May take some account of factors in addition to the magnitude of sound (especially time of day). An example is day-evening-night level L_{DEN}
Noise level	A decibel measure of sound on a scale which indicates its loudness or noisiness. For environmental noise from aircraft, two scales are generally used: A-weighted sound level and Perceived Noise Level. These scales apply different weights to sound of different frequencies — to mimic human perception
Noise metric	An expression used to describe any measure of quantity of noise at a receiver position whether it be a single event or an accumulation of noise over extended time. There are two commonly used measures of single event noise: the <i>maximum level</i> reached during the event, or its <i>sound exposure level</i> , a measure of its total sound energy determined by time integration
Noise-power-distance (NPD) relationships/data	Noise event levels tabulated as a function of distance below an aeroplane in steady level flight at a reference speed in a reference atmosphere, for each of a number of → <i>engine power settings</i> . The data account for the effects of sound attenuation due to spherical wave spreading (inverse-square law) and atmospheric absorption. The distance is defined perpendicular to the aeroplane flight path and the aircraft wing-axis (i.e. vertically below the aircraft in non-banked flight)
Noise-related power parameter	Parameter that describes or indicates the propulsive effort generated by an aircraft engine to which acoustic power emission can logically be related; usually taken to be → <i>corrected net thrust</i> . Loosely termed ‘power’ or ‘power setting’ throughout the text
Noise significance	The contribution from a flight path segment is ‘noise significant’ if it affects the event noise level to an appreciable extent. Disregarding segments that are not noise-significant yields massive savings in computer processing
Observer	→ <i>Receiver</i>
Procedural steps	Prescription for flying a profile — steps include changes of speed and/or altitude
Profile point	Height of flight path segment end point — in vertical plane above the ground track
Receiver	A recipient of noise that arrives from a source; principally at a point on or near the ground surface
Reference atmosphere	A tabulation of sound absorption rates used to standardise NPD data (see Appendix D)
Reference day	A set of atmospheric conditions on which ANP data are standardised
Reference duration	A nominal time interval used to standardise single event sound exposure level measurements; equal to 1 second in the case of → <i>SEL</i>

Reference speed	Aeroplane groundspeed to which <i>NPD</i> → <i>SEL</i> data are normalised
<i>SEL</i>	→ <i>Sound Exposure Level</i>
Single event sound exposure level	The sound level an event would have if all its sound energy were compressed uniformly into a standard time interval known as the → <i>reference duration</i>
Soft ground	A ground surface that is acoustically 'soft', typically grassy, that surrounds most aerodromes. Acoustically hard, i.e. highly reflective, ground surfaces includes concrete and water. The noise contour methodology described herein applies to soft ground conditions
Sound	Energy transmitted through air by (longitudinal) wave motion which is sensed by the ear
Sound attenuation	The decrease in sound intensity with distance along a propagation path. For aircraft noise its causes include spherical wave spreading, atmospheric absorption and → <i>lateral attenuation</i>
Sound exposure	A measure of total sound energy immission over a period of time
Sound Exposure Level, L_{AE}	(Acronym SEL) A metric standardised in ISO 1996-1 or ISO 3891 = A-weighted single event sound exposure level referenced to 1 second
Sound intensity	The strength of sound immission at a point — related to acoustical energy (and indicated by measured sound levels)
Sound level	A measure of sound energy expressed in decibel units. Received sound is measured with or without 'frequency weighting'; levels measured with a weighting are often termed → <i>noise levels</i>
Stage/trip length	Distance to first destination of departing aircraft; taken to be an indicator of aircraft weight
Start of Roll, SOR	The point on the runway from which a departing aircraft commences its take-off. Also termed 'brake release'
True airspeed	Actual speed of aircraft relative to air (= groundspeed in still air)
Weighted equivalent sound level, $L_{eq,W}$	An modified version of L_{eq} in which different weights are assigned to noise occurring during different period of the day (usually day, evening and night)

Symbols

d	Shortest distance from an observation point to a flight path segment
d_p	Perpendicular distance from an observation point to the flight path (slant distance or slant range)
d_λ	Scaled distance
F_n	Actual net thrust per engine
F_n/δ	Corrected net thrust per engine
h	Aircraft altitude (above MSL)
L	Event noise level (scale undefined)
$L(t)$	Sound level at time t (scale undefined)

$L_A, L_A(t)$	A-weighted sound pressure level (at time t) — measured on the <i>slow</i> sound level meter scale
L_{AE}	(SEL) Sound Exposure Level
L_{Amax}	Maximum value of $L_A(t)$ during an event
L_E	Single event sound exposure level
L_{Eso}	Single event sound exposure level determined from NPD database
L_{EPN}	Effective Perceived Noise Level
L_{eq}	Equivalent (continuous) sound level
L_{max}	Maximum value of $L(t)$ during an event
$L_{max,seg}$	Maximum level generated by a segment
ℓ	Perpendicular distance from an observation point to the ground track
\lg	Logarithm to base 10
N	Number of segments or sub-segments
NAT	Number of events with L_{max} exceeding a specified threshold
P	Power parameter in NPD variable $L(P,d)$
P_{seg}	Power parameter relevant to a particular segment
q	Distance from start of segment to closest point of approach
R	Radius of turn
S	Standard deviation
s	Distance along ground track
s_{RWY}	Runway length
t	Time
t_e	Effective duration of single sound event
t_0	Reference time for integrated sound level
V	Groundspeed
V_{seg}	Equivalent segment groundspeed
V_{ref}	Reference groundspeed for which NPD data are defined
x,y,z	Local coordinates
x',y',z'	Aircraft coordinates
$X_{ARP}, Y_{ARP}, Z_{ARP}$	Position of aerodrome reference point in geographical coordinates
z	Height of aircraft above ground plane/aerodrome reference point
α	Parameter used for calculation of the finite segment correction D_F
β	Elevation angle of aircraft relative to ground plane
ϵ	Aircraft bank angle
γ	Climb/descent angle

φ	Depression angle (lateral directivity parameter)
λ	Total segment length
ψ	Angle between direction of aircraft movement and direction to observer
ξ	Aircraft heading, measured clockwise from magnetic north
$\Lambda(\beta, \ell)$	Air-to-ground lateral attenuation
$\Lambda(\beta)$	Long range air-to-ground lateral attenuation
$\Gamma(\ell)$	Lateral attenuation distance factor
Δ	Change in value of a quantity, or a correction (as indicated in the text)
Δ_F	Finite segment correction
Δ_I	Engine installation correction
Δ_i	Weighting for <i>i</i> th time of day period, dB
Δ_{rev}	Reverse thrust
Δ_{SOR}	Start of roll correction
Δ_V	Duration (speed) correction

Subscripts

1, 2	Subscripts denoting start and end values of an interval or segment
<i>E</i>	Exposure
<i>i</i>	Aircraft type/category summation index
<i>j</i>	Ground track/subtrack summation index
<i>k</i>	Segment summation index
<i>max</i>	Maximum
<i>ref</i>	Reference value
<i>seg</i>	Segment specific value
<i>SOR</i>	Related to start of roll
<i>TO</i>	Takeoff

2.6.2. Quality framework

Accuracy of input values

All input values affecting the emission level of a source, including the position of the source, shall be determined with at least the accuracy corresponding to an uncertainty of $\pm 2\text{dB(A)}$ in the emission level of the source (leaving all other parameters unchanged).

Use of default values

In the application of the method, the input data shall reflect the actual usage. In general there shall be no reliance on default input values or assumptions. Specifically, flight paths derived from radar data to derive the flight paths shall be used whenever they exist and is of sufficient quality. Default input values and assumptions are accepted, for example, to be used for modelled routes instead of radar derived flight paths, if the collection of real data is associated with disproportionately high costs.

Quality of the software used for the calculations

Software used to perform the calculations shall prove compliance with the methods herewith described by means of certification of results against test cases.

2.7. Aircraft noise

2.7.1. Aim and scope of document

Contour maps are used to indicate the extent and magnitude of aircraft noise impact around airports, that impact being indicated by values of a specified noise metric or index. A contour is a line along which the index value is constant. The index value aggregates in some way all the individual aircraft noise events that occur during some specified period of time, normally measured in days or months.

The noise at points on the ground from aircraft flying into and out of a nearby aerodrome depends on many factors. Principal among these are the types of aeroplane and their powerplant; the power, flap and airspeed management procedures used on the aeroplanes themselves; the distances from the points concerned to the various flight paths; and local topography and weather. Airport operations generally include different types of aeroplanes, various flight procedures and a range of operational weights.

Contours are generated by calculating surfaces of local noise index values mathematically. This document explains in detail how to calculate, at one observer point, the individual aircraft noise event levels, each for a specific aircraft flight or type of flight, that are subsequently averaged in some way, or *accumulated*, to yield index values at that point. The required surface of index values is generated merely by repeating the calculations as necessary for different aircraft movements — taking care to maximise efficiency by excluding events that are not ‘noise-significant’ (i.e. which do not contribute significantly to the total).

Where noise generating activities associated with airport operations do not contribute materially to the overall population exposure to aircraft noise and associated noise contours, they may be excluded. These activities include: helicopters, taxiing, engine testing and use of auxiliary power-units. This does not necessarily mean that their impact is insignificant and where these circumstances occur assessment of the sources can be undertaken as set out in paragraphs 2.7.21 and 2.7.22.

2.7.2. Outline of the document

The noise contour generation process is illustrated in **Figure 2.7.a**. Contours are produced for various purposes and these tend to control the requirements for sources and pre-processing of input data. Contours that depict historical noise impact might be generated from actual records of aircraft operations — of movements, weights, radar-measured flight paths, etc. Contours used for future planning purposes of necessity rely more on forecasts — of traffic and flight tracks and the performance and noise characteristics of future aircraft.

Figure 2.7.a

The noise contour generation process

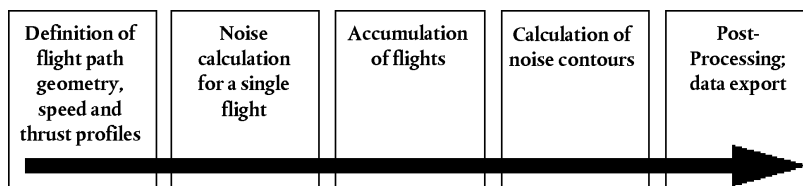

Whatever the source of flight data, each different aircraft movement, arrival or departure, is defined in terms of its flight path geometry and the noise emission from the aircraft as it follows that path (movements that are essentially the same in noise and flight path terms are included by simple multiplication). The noise emission depends on the characteristics of the aircraft — mainly on the power generated by its engines. The recommended methodology involves dividing the flight path into segments. **Sections 2.7.3 to 2.7.6** outline the elements of the methodology and explain the principle of segmentation on which it is based; that the observed event noise level is an aggregation of contributions from all 'noise-significant' segments of the flight path, each of which can be calculated independently of the others. **Sections 2.7.3 to 2.7.6** also outline the input data requirements for producing a set of noise contours. Detailed specifications for the operational data needed are set out in **Appendix A**.

How the flight path segments are calculated from pre-processed input data is described in **Sections 2.7.7 to 2.7.13**. This involves applications of aircraft flight performance analysis, equations for which are detailed in **Appendix B**. Flight paths are subject to significant variability — aircraft following any route are dispersed across a swathe due to the effects of differences in atmospheric conditions, aircraft weights and operating procedures, air traffic control constraints, etc. This is taken into account by describing each flight path statistically — as a central or 'backbone' path which is accompanied by a set of dispersed paths. This too is explained in **Sections 2.7.7 to 2.7.13** with reference to additional information in **Appendix C**.

Sections 2.7.14 to 2.7.19 set out the steps to be followed in calculating the noise level of one single event — the noise generated at a point on the ground by one aircraft movement. **Appendix D** deals with the re-calculation of NPD-data for non-reference conditions. **Appendix E** explains the acoustic dipole source used in the model to define sound radiation from flight path segments of finite length.

Applications of the modelling relationships described in Chapters 3 and 4 require, apart from the relevant flight paths, appropriate noise and performance data for the aircraft in question.

Determining the event level for a single aircraft movement at a single observer point is the core calculation. It has to be repeated for all aircraft movements at each of a prescribed array of points covering the expected extent of the required noise contours. At each point the event levels are aggregated or averaged in some way to arrive at a 'cumulative level' or noise index value. This part of the process is described in **Sections 2.7.20 and 2.7.23 to 2.7.25**.

Sections 2.7.26 to 2.7.28 summarise the options and requirement for fitting noise contours to arrays of noise index values. They provide guidance on contour generation and post-processing.

2.7.3. *The concept of segmentation*

For any specific aircraft, the database contains baseline Noise-Power-Distance (NPD) relationships. These define, for steady straight flight at a *reference speed* in specified *reference atmospheric conditions* and in a specified flight configuration, the received sound event levels, both maximum and time integrated, directly beneath the aircraft ⁽¹⁾ as a function of distance. For noise modelling purposes, the all-important propulsive power is represented by a *noise-related power parameter*; the parameter generally used is *corrected net thrust*. Baseline event levels determined from the database are adjusted to account for, firstly, differences between actual (i.e. modelled) and reference atmospheric conditions and (in the case of sound exposure levels) aircraft speed and, secondly, for receiver points that are not directly beneath the aircraft, differences between downwards and laterally radiated noise. This latter difference is due to *lateral directivity* (engine installation effects) and *lateral attenuation*. But the event levels so adjusted still apply only to the total noise from the aircraft in steady level flight.

⁽¹⁾ Actually beneath the aircraft perpendicular to the wing axis and direction of flight; taken to be vertically below the aircraft when in non-turning (i.e. non-banked) flight.

Segmentation is the process by which the recommended noise contour model adapts the infinite path NPD and lateral data to calculate the noise reaching a receiver from a non-uniform flight path, i.e. one along which the aircraft flight configuration varies. For the purposes of calculating the event sound level of an aircraft movement, the flight path is represented by a set of contiguous straight-line segments, each of which can be regarded as a finite part of an infinite path for which an NPD and the lateral adjustments are known. The maximum level of the event is simply the greatest of the individual segment values. The time integrated level of the whole noise event is calculated by summing the noise received from a sufficient number of segments, i.e. those which make a significant contribution to the total event noise.

The method for estimating how much noise one finite segment contributes to the integrated event level is a purely empirical one. The *energy fraction* F — the segment noise expressed as a proportion of the total infinite path noise — is described by a relatively simple expression which allows for the longitudinal directivity of aircraft noise and the receiver's 'view' of the segment. One reason why a simple empirical method is generally adequate is that, as a rule, most of the noise comes from the nearest, usually, adjacent segment — for which the *closest point of approach* (CPA) to the receiver lies within the segment (not at one of its ends). This means that estimates of the noise from non-adjacent segments can be increasingly approximate as they get further away from the receiver without compromising the accuracy significantly.

2.7.4. *Flight paths: Tracks and profiles*

In the modelling context, a *flight path* (or trajectory) is a full description of the motion of the aircraft in space and time ⁽¹⁾. Together with the propulsive thrust (or other noise related power parameter) this is the information required to calculate the noise generated. The *ground track* is the vertical projection of the flight path on level ground. This is combined with the vertical *flight profile* to construct the 3-D flight path. Segmentation modelling requires that the flight path of every different aircraft movement is described by a series of contiguous straight segments. The manner in which the segmentation is performed is dictated by a need to balance accuracy and efficiency — it is necessary to approximate the real curved flight path sufficiently closely while minimising the computational burden and data requirements. Each segment has to be defined by the geometrical coordinates of its end points and the associated speed and engine power parameters of the aircraft (on which sound emission depends). Flight paths and engine power may be determined in various ways, the main ones involving (a) synthesis from a series of procedural steps and (b) analysis of measured flight profile data.

Synthesis of the flight path (a) requires knowledge of (or assumptions for) ground tracks and their lateral dispersions, aircraft weight, speed, flap and thrust-management procedures, airport elevation, and wind and air temperature. Equations for calculating the flight profile from the required propulsion and aerodynamic parameters are given in **Appendix B**. Each equation contains coefficients (and/or constants) which are based on empirical data for each specific aircraft type. The aerodynamic-performance equations in **Appendix B** permit the consideration of any reasonable combination of aircraft operational weight and flight procedure, including operations at different takeoff gross weights.

Analysis of measured data (b), e.g. from flight data recorders, radar or other aircraft tracking equipment, involves 'reverse engineering', effectively a reversal of the synthesis process (a). Instead of estimating the aircraft and powerplant states at the ends of the flight segments by integrating the effects of the thrust and aerodynamic forces acting on the airframe, the forces are estimated by differentiating the changes of height and speed of the airframe. Procedures for processing the flight path information are described in Section 2.7.12.

In an ultimate noise modelling application, each individual flight could, theoretically, be represented independently; this would guarantee accurate accounting for the spatial dispersion of flight paths — which can be very significant. But to keep data preparation and computer time within reasonable bounds it is normal practice to represent flight path swathes by a small number of laterally displaced 'subtracks'. (Vertical dispersion is usually represented satisfactorily by accounting for the effects of varying aircraft weights on the vertical profiles.)

⁽¹⁾ Time is accounted for via the aircraft speed.

2.7.5. *Aircraft noise and performance*

The ANP database provided in Appendix I covers most existing aircraft types. For aircraft types or variants for which data are not currently listed, they can best be represented by data for other, normally similar, aircraft that are listed.

The ANP database includes default 'procedural steps' to enable the construction of flight profiles for at least one common noise abatement departure procedure. More recent database entries cover two different noise abatement departure procedures.

2.7.6. *Airport and aircraft operations*

Case-specific data from which to calculate the noise contours for a particular airport scenario includes the following.

General airport data

- The aerodrome reference point (simply to locate the aerodrome in appropriate geographic coordinates). The reference point is set as the origin of the local Cartesian coordinate system used by the calculation procedure.
- The aerodrome reference altitude (= altitude of aerodrome reference point). This is the altitude of the nominal ground plane on which, in the absence of topography corrections, the noise contours are defined.
- Average meteorological parameters at or close to the aerodrome reference point (temperature, relative humidity, average windspeed and wind direction).

Runway data

For each runway:

- Runway designation
- Runway reference point (centre of runway expressed in local coordinates)
- Runway length, direction and mean gradient
- Location of start-of-roll and landing threshold ⁽¹⁾.

Ground track data

Aircraft ground tracks shall be described by a series of coordinates in the (horizontal) ground-plane. The source of ground track data depends on whether relevant radar data are available or not. If they are, a reliable backbone track and suitable associated (dispersed) sub-tracks shall be established by statistical analysis of the data. If not, backbone tracks are usually constructed from appropriate procedural information, e.g. using standard instrument departure procedures from Aeronautical Information Publications. This conventional description includes the following information:

- Designation of the runway the track originates from
- Description of the track origin (start of roll, landing threshold)
- Length of segments (for turns, radius and change of direction).

⁽¹⁾ Displaced thresholds can be taken into account by defining additional runways.

This information is the minimum necessary to define the core (backbone) track. But average noise levels calculated on the assumption that aircraft follow the nominal routes exactly can be liable to localised errors of several decibels. Thus lateral dispersion shall be represented, and the following additional information is necessary:

- Width of the swathe (or other dispersion statistic) at each segment end
- Number of subtracks
- Distribution of movements perpendicular to the backbone track.

Air traffic data

Air traffic data are

- the time period covered by the data and
- the number of movements (arrivals or departures) of each aircraft type on each flight track, subdivided by (1) time of day as appropriate for specified noise descriptors, (2) for departures, operating weights or stage lengths, and (3), if necessary, operating procedures.

Most noise descriptors require that events (i.e. aircraft movements) are defined as average daily values during specified periods of the day (e.g. day, evening and night) — see **Sections 2.7.23 to 2.7.25**.

Topographical data

The terrain around most airports is relatively flat. However this is not always the case and there may sometimes be a need to account for variations in terrain elevation relative to the airport reference elevation. The effect of terrain elevation can be especially important in the vicinity of approach tracks, where the aircraft is operating at relatively low altitudes.

Terrain elevation data are usually provided as a set of (x,y,z) coordinates for a rectangular grid of certain mesh-size. But the parameters of the elevation grid are likely to be different from those of the grid used for the noise computation. If so linear interpolation may be used to estimate the appropriate z-coordinates in the latter.

Comprehensive analysis of the effects of markedly non-level ground on sound propagation is complex and beyond the scope of this method. Moderate unevenness can be accounted for by assuming 'pseudo-level' ground; i.e. simply raising or lowering the level ground plane to the local ground elevation (relative to the reference ground plane) at each receiver point (see Section 2.7.4).

Reference conditions

The international aircraft noise and performance (ANP) data are normalised to standard reference conditions that are widely used for airport noise studies (see **Appendix D**).

Reference conditions for NPD data

- (1) Atmospheric pressure: 101,325 kPa (1 013,25 mb)
- (2) Atmospheric absorption: Attenuation rates listed in **Table D-1 of Appendix D**

- (3) Precipitation: None
- (4) Wind Speed: Less than 8 m/s (15 knots)
- (5) Groundspeed: 160 knots
- (6) Local terrain: Flat, soft ground free of large structures or other reflecting objects within several kilometres of aircraft ground tracks.

Standardised aircraft sound measurements are made 1,2 m above the ground surface. However no special account of this is necessary as, for modelling purposes, it may be assumed that event levels are relatively insensitive to receiver height ⁽¹⁾.

Comparisons of estimated and measured airport noise levels indicate that the NPD data can be assumed applicable when the near surface average conditions lie within the following envelope:

- Air temperature less than 30 °C
- Product of air temperature (°C), and relative humidity, (percent) greater than 500
- Wind speed less than 8 metres per second (15 knots).

This envelope is believed to encompass conditions encountered at most of the world's major airports. **Appendix D** provides a method for converting NPD data to average local conditions which fall outside it, but, in extreme cases, it is suggested that the relevant aeroplane manufacturers be consulted.

Reference conditions for aeroplane aerodynamic and engine data

- (1) Runway Elevation: Mean sea level
- (2) Air temperature: 15 °C
- (3) Takeoff gross weight: As defined as a function of stage length in the ANP database
- (4) Landing gross weight: 90 percent of maximum landing gross weight
- (5) Engines supplying thrust: All

Although ANP aerodynamic and engine data are based on these conditions, they can be used as tabulated for non-reference runway elevations and average air temperatures in ECAC states without significantly affecting the accuracy of the calculated contours of cumulative average sound level. (see **Appendix B**.)

The ANP database tabulates aerodynamic data for the takeoff and landing gross weights noted in items 3 and 4 above. Although, for cumulative noise calculations, the aerodynamic data themselves need not be adjusted for other gross weights, calculation of the takeoff and climbout flight profiles, using the procedures described in **Appendix B**, shall be based on the appropriate operational takeoff gross weights.

⁽¹⁾ Calculated levels at 4 m or higher are sometimes requested. Comparison of measurements at 1,2 m and 10 m and theoretical calculation of ground effects show that variations of the A-weighted sound exposure level are relatively insensitive to receiver height. The variations are in general smaller than one decibel, except if the maximum angle of sound incidence is below 10° and if the A-weighted spectrum at the receiver has its maximum in the range of 200 to 500 Hz. Such low frequency dominated spectra may occur e.g. at long distances for low-bypass ratio engines and for propeller engines with discrete low frequency tones.

2.7.7. Description of the flight path

The noise model requires that each different aircraft movement is described by its three-dimensional flight path and the varying engine power and speed along it. As a rule, one modelled movement represents a subset of the total airport traffic, e.g. a number of (assumed) identical movements, with the same aircraft type, weight and operating procedure, on a single ground track. That track may itself be one of several dispersed 'sub-tracks' used to model what is really a swathe of tracks following one designated route. The ground track swathes, the vertical profiles and the aircraft operational parameters are all determined from the input scenario data — in conjunction with aircraft data from the ANP database.

The noise-power-distance data (in the ANP database) define noise from aircraft traversing idealised horizontal flight paths of infinite length at constant speed and power. To adapt this data to terminal area flight paths that are characterised by frequent changes of power and velocity, every path is broken into finite straight-line segments; the noise contributions from each of these are subsequently summed at the observer position.

2.7.8. Relationships between flight path and flight configuration

The three-dimensional flight path of an aircraft movement determines the geometrical aspects of sound radiation and propagation between aircraft and observer. At a particular aircraft weight and in particular atmospheric conditions, the flight path is governed entirely by the sequence of power, flap and altitude changes that are applied by the pilot (or automatic flight management system) in order to follow routes and maintain heights and speeds specified by ATC — in accordance with the aircraft operator's standard operating procedures. These instructions and actions divide the flight path into distinct phases which form natural segments. In the horizontal plane they involve straight legs, specified as a distance to the next turn, and turns, defined by radius and change of heading. In the vertical plane, segments are defined by the time and/or distance taken to achieve required changes of forward speed and/or height at specified power and flap settings. The corresponding vertical coordinates are often referred to as *profile points*.

For noise modelling, flight path information is generated either by *synthesis* from a set of procedural steps (i.e. those followed by the pilot) or by *analysis* of radar data — physical measurements of actual flight paths flown. Whatever method is used, both horizontal and vertical shapes of the flight path, are reduced to segmented forms. Its horizontal shape (i.e. its 2-dimensional projection on the ground) is the *ground track* defined by the inbound or outbound routeing. Its vertical shape, given by the profile points, and the associated flight parameters speed, bank angle and power setting, together define the *flight profile* which depends on the *flight procedure* that is normally prescribed by the aircraft manufacturer and/or the operator. The flight path is constructed by merging the 2-D flight profile with the 2-D ground track to form a sequence of 3-D flight path segments.

It should be remembered that, for a given set of procedural steps, the profile depends on the ground track; e.g. at the same thrust and speed the aircraft climb rate is less in turns than in straight flight. Although this guidance explains how to take this dependency into account, it has to be acknowledged that doing so would normally involve a very large computing overhead and users may prefer to assume that, for noise modelling purposes, the flight profile and ground track can be treated as independent entities; i.e. that the climb profile is unaffected by any turns. However, it is important to determine changes of bank angle that turns require as this has an important bearing on the directionality of sound emission.

The noise received from a flight path segment depends on the geometry of the segment in relation to the observer and the aircraft flight configuration. But these are interrelated — a change in one causes a change in the other and it is necessary to ensure that, at all points on the path, the configuration of the aircraft is consistent with its motion along the path.

In a flight path synthesis, i.e. when constructing a flight path from a set of 'procedural steps' that describe the pilot's selections of engine power, flap angle, and acceleration/vertical speed, it is the motion that has to be calculated. In a flight path analysis, the reverse is the case: the engine power settings have to be estimated from the observed motion of the aeroplane — as determined from radar data, or sometimes, in special studies, from aircraft flight recorder data (although in the latter case engine power is usually part of the data). In either case, the coordinates and flight parameters at all segment end points have to be fed into the noise calculation.

Appendix B presents the equations that relate the forces acting on an aircraft and its motion and explains how they are solved to define the properties of the segments that make up the flight paths. The different kinds of segments (and the sections of **Appendix B** that cover them) are *take-off ground roll* (B5), *climb at constant speed* (B6), *power cutback* (B7), *accelerating climb and flap retraction* (B8), *accelerating climb after flap retraction* (B9), *descent and deceleration* (B10) and *final landing approach* (B11).

Inevitably, practical modelling involves varying degrees of simplification — the requirement for this depends on the nature of the application, the significance of the results and the resources available. A general simplifying assumption, even in the most elaborate applications, is that when accounting for flight track dispersion, the flight profiles and configurations on all the sub-tracks are the same as those on the backbone track. As at least 6 subtracks are to be used (see Section 2.7.11) this reduces computations massively for an extremely small penalty in fidelity.

2.7.9. Sources of flight path data

Radar data

Although aircraft flight data recorders can yield very high quality data, this is difficult to obtain for noise modelling purposes and radar data shall be regarded as the most readily accessible source of information on actual flight paths flown at airports ⁽¹⁾. As it is usually available from airport noise and flight path monitoring systems, it is now used increasingly for noise modelling purposes.

Secondary surveillance radar presents the flight path of an aircraft as a sequence of positional coordinates at intervals equal to the period of rotation of the radar scanner, typically about 4 seconds. The position of the aircraft over the ground is determined in polar coordinates — range and azimuth — from the reflected radar return (although the monitoring system normally transforms these to Cartesian coordinates); its height ⁽²⁾ is measured by the aeroplane's own altimeter and transmitted to the ATC computer by a radar-triggered transponder. But inherent positional errors due to radio interference and limited data resolution are significant (although of no consequence for the intended air traffic control purposes). Thus, if the flight path of a specific aircraft movement is required, it is necessary to smooth the data using an appropriate curve-fitting technique. However, for noise modelling purposes the usual requirement is for a statistical description of a swathe of flight paths; e.g. for all movements on a route or for just those of a specific aircraft type. Here the measurement errors associated with the relevant statistics can be reduced to insignificance by the averaging processes.

Procedural steps

In many cases is not possible to model flight paths on the basis of radar data — because the necessary resources are not available or because the scenario is a future one for which there are no relevant radar data.

In the absence of radar data, or when its use is inappropriate, it is necessary to estimate the flight paths on the basis of operational guidance material, for example instructions given to flight crews via AIPs and aircraft operating manuals — referred to here as *procedural steps*. Advice on interpreting this material shall be sought from air traffic control authorities and the aircraft operators where necessary.

⁽¹⁾ Aircraft flight data recorders provide comprehensive operational data. However this is not readily accessible and is costly to provide; thus its use for noise modelling purposes is normally restricted to special projects and model development studies.

⁽²⁾ Usually measured as altitude above MSL (i.e. relative to 1 013 mb) and corrected to airport elevation by the airport monitoring system.

2.7.10. Coordinate systems

The local coordinate system

The local coordinate system (x,y,z) is a Cartesian one and has its origin $(0,0,0)$ at the aerodrome reference point $(X_{ARP}, Y_{ARP}, Z_{ARP})$, where Z_{ARP} is the airport reference altitude and $z = 0$ defines the nominal ground plane on which contours are usually calculated. The aircraft heading ξ in the xy -plane is measured clockwise from magnetic north (see **Figure 2.7.b**). All observer locations, the basic calculation grid and the noise contour points are expressed in local coordinates ⁽¹⁾.

Figure 2.7.b

Local coordinate system (x,y,z) and ground-track fixed coordinate s

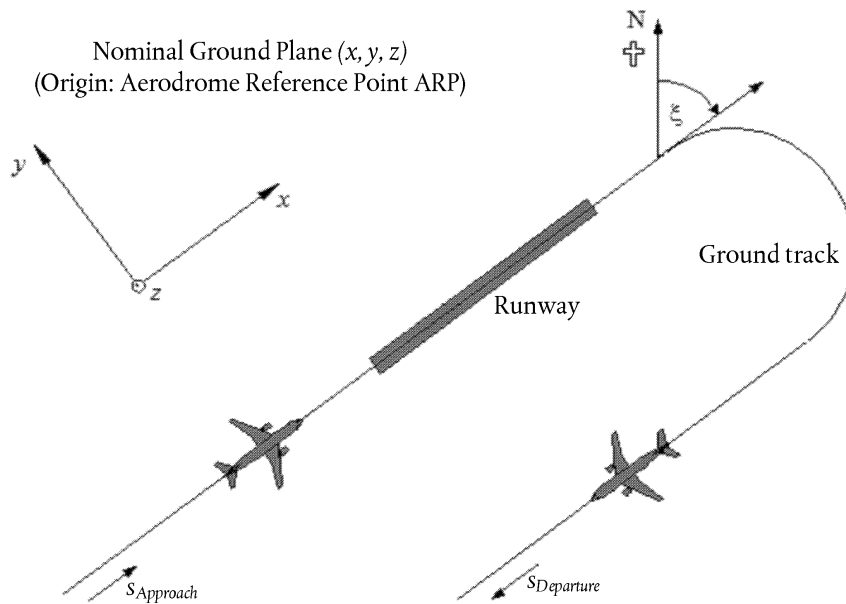

The ground-track fixed coordinate system

This coordinate is specific for each ground track and represents distance s measured along the track in the flight direction. For departure tracks s is measured from the start of roll, for approach tracks from the landing threshold. Thus s becomes negative in areas

- behind the start of roll for departures and
- before crossing the runway landing threshold for approaches.

⁽¹⁾ Usually the axes of the local coordinate are parallel to the axis of the map that contours are drawn on. However it is sometimes useful to choose the x-axis parallel to a runway in order to get symmetrical contours without using a fine computational grid (see **Sections 2.7.26 to 2.7.28**).

Flight operational parameters such as height, speed and power setting are expressed as functions of s .

The aircraft coordinate system

The aircraft-fixed Cartesian coordinate system (x', y', z') has its origin at the actual aircraft location. The axis-system is defined by the climb-angle γ , the flight direction ξ and the bank-angle ε (see **Figure 2.7.c**).

Figure 2.7.c

Aircraft fixed coordinate system (x', y', z')

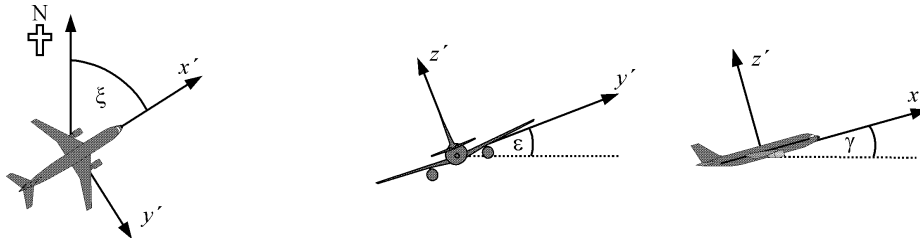

Accounting for topography

In cases where topography has to be taken into account (see Section 2.7.6), the aircraft height coordinate z has to be replaced by $z' = z - z_o$ (where z_o is the z -coordinate of the observer location O) when estimating the propagation distance d . The geometry between aircraft and observer is shown in **Figure 2.7.d**. For the definitions of d and ℓ see Sections 2.7.14 to 2.7.19 ⁽¹⁾.

Figure 2.7.d

Ground elevation along (left) and lateral (right) to ground track

(The nominal ground plane $z = 0$ passes through the aerodrome reference point. O is the observer location.)

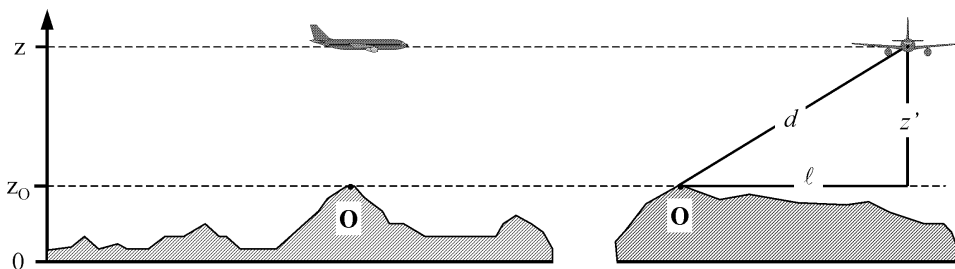

⁽¹⁾ For non-level ground it is possible for the observer to be above the aircraft in which case, for calculating sound propagation z' (and the corresponding elevation angle β — see Chapter 4) is put equal to zero.

2.7.11. Ground Tracks

Backbone tracks

The backbone track defines the centre of the swathe of tracks followed by aircraft using a particular routing. For the purposes of aircraft noise modelling it is defined either (i) by prescriptive operational data such as the instructions given to pilots in AIPs, or (ii) by statistical analysis of radar data as explained in Section 2.7.9 — when this is available and appropriate to the needs of the modelling study. Constructing the track from operational instructions is normally quite straightforward as these prescribe a sequence of legs which are either straight — defined by length and heading, or circular arcs defined by turn rate and change of heading; see **Figure 2.7.e** for an illustration.

Figure 2.7.e

Ground track geometry in terms of turns and straight segments

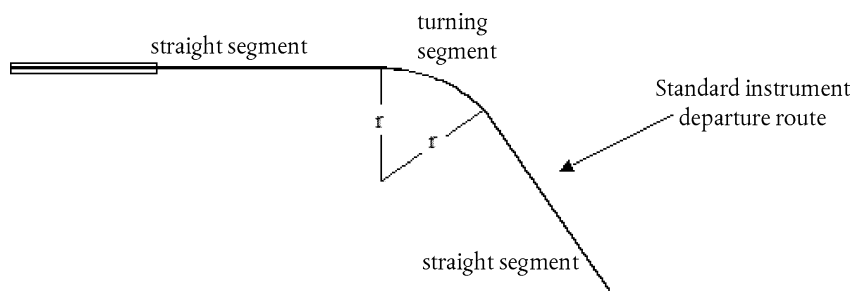

Fitting a backbone track to radar data is more complex, firstly because actual turns are made at a varying rate and secondly because its line is obscured by the scatter of the data. As explained, formalised procedures have not yet been developed and it is common practice to match segments, straight and curved, to the average positions calculated from cross-sections of radar tracks at intervals along the route. Computer algorithms to perform this task are likely to be developed in future but, for the present, it is for the modeller to decide how to use available data to best advantage. A major factor is that the aircraft speed and turn radius dictate the angle of bank and, as will be seen in Section 2.7.19, non-symmetries of sound radiation around the flight path govern noise on the ground, as well as the position of the flight path itself.

Theoretically, seamless transition from straight flight to fixed radius turn would require an instantaneous application of bank angle ϵ , which is physically impossible. In reality it takes a finite time for the bank angle to reach the value required to maintain a specified speed and turn radius r , during which the turn radius tightens from infinity to r . For modelling purposes the radius transition can be disregarded and the bank angle assumed to increase steadily from zero (or other initial value) to ϵ at the start of the turn and to be the next value of ϵ at the end of the turn ⁽¹⁾.

Track dispersion

Where possible, definitions of lateral dispersion and representative sub-tracks shall be based on relevant past experience from the study airport; normally via an analysis of radar data samples. The first step is to group the data by route. Departure tracks are characterised by substantial lateral dispersion which, for accurate modelling, has to be taken into account. Arrival routes normally coalesce into a very narrow swathe about the final approach path and it is usually sufficient to represent all arrivals by a single track. But if the approach swathes are wide within the region of the noise contours they might need to be represented by sub-tracks in the same way as departure routes.

⁽¹⁾ How best to implement this is left to the user as this will depend on the way in which turn radii are defined. When the starting point is a sequence of straight or circular legs, a relatively simple option is to insert bank angle transition segments at the start of the turn and at its end in which the aircraft rolls at a constant rate (e.g. expressed in $^{\circ}/m$ or $^{\circ}/s$).

It is common practice to treat the data for a single route as a sample from a single population; i.e. to be represented by one backbone track and one set of dispersed subtracks. However, if inspection indicates that the data for different categories of aircraft or operations differ significantly (e.g. should large and small aircraft have substantially different turn radii), further subdivision of the data into different swathes may be desirable. For each swathe, the lateral track dispersions are determined as a function of distance from the origin; movements then being apportioned between a backbone track and a suitable number of dispersed sub-tracks on the basis of the distribution statistics.

As it is normally unwise to disregard the effects of track dispersion, in the absence of measured swathe data a nominal lateral spread across and perpendicular to the backbone track shall be defined by a conventional distribution function. Calculated values of noise indices are not particularly sensitive to the precise shape of the lateral distribution: the Normal (Gaussian) Distribution provides an adequate description of many radar-measured swathes.

Typically a 7-point discrete approximation is used (i.e. representing the lateral dispersion by 6 subtracks equally spaced around the backbone track). The spacing of the subtracks depends on the standard deviation of the lateral dispersion function.

For normally distributed tracks with a standard deviation S , 98,8 % of the tracks are located within a corridor with boundaries located at $\pm 2,5 \cdot S$. **Table 2.7.a** gives the spacing of the six subtracks and the percentage of the total movements assigned to each. **Appendix C** gives values for other numbers of subtracks.

Table 2.7.a

Percentages of movements for a normal distribution function with standard deviation S for 7 subtracks (backbone track is subtrack 1)

Subtrack number	Location of subtrack	Percentage of movements on subtrack
7	$- 2,14 \cdot S$	3 %
5	$- 1,43 \cdot S$	11 %
3	$- 0,71 \cdot S$	22 %
1	0	28 %
2	$0,71 \cdot S$	22 %
4	$1,43 \cdot S$	11 %
6	$2,14 \cdot S$	3 %

The standard deviation S is a function of the coordinate s along the backbone-track. It can be specified — together with the description of the backbone-track — in the flight track data sheet shown in **Appendix A3**. In the absence of any indicators of the standard deviation — e.g. from radar data describing comparable flight tracks — the following values are recommended:

For tracks involving turns of less than 45 degrees:

$$\begin{aligned}
 S(s) &= 0,055 \cdot s - 150 && \text{for } 2\,700 \text{ m} \leq s \leq 30\,000 \text{ m} \\
 S(s) &= 1\,500 && \text{for } s > 30\,000 \text{ m}
 \end{aligned}
 \tag{2.7.1}$$

For tracks involving turns of more than 45 degrees:

$$\begin{aligned} S(s) &= 0,128 \cdot s - 420 && \text{for } 3\,300 \text{ m} \leq s \leq 15\,000 \text{ m} \\ S(s) &= 1\,500 \text{ m} && \text{for } s > 15\,000 \text{ m} \end{aligned} \tag{2.7.2}$$

For practical reasons, $S(s)$ is assumed to be zero between the start of roll and $s = 2\,700 \text{ m}$ or $s = 3\,300 \text{ m}$ depending on the amount of turn. Routes involving more than one turn shall be treated as per equation (2.7.2). For arrivals, lateral dispersion can be neglected within 6 000 m of touchdown.

2.7.12. Flight profiles

The flight profile is a description of the aircraft motion in the vertical plane above the ground track, in terms of its position, speed, bank angle and engine power setting. One of the most important tasks facing the model user is that of defining aircraft flight profiles that adequately meet the requirements of the modelling application — efficiently, without consuming excessive time and resources. Naturally, to achieve high accuracy, the profiles have to reflect closely the aircraft operations they are intended to represent. This requires reliable information on the atmospheric conditions, aircraft types and variants, operating weights and the operating procedures — the variations of thrust and flap settings and the trade-offs between changes of height and speed — all appropriately averaged over the time period(s) of interest. Often such detailed information are not available but this is not necessarily an obstacle; even if they are, the modeller has to exercise judgement to balance the accuracy and detail of the input information with the needs for, and uses of, the contour outputs.

The synthesis of flight profiles from 'procedural steps' obtained from the ANP database or from aircraft operators is described in Section 2.7.13 and **Appendix B**. That process, usually the only recourse open to the modeller when no radar data are available, yields both the flight path geometry and the associated speed and thrust variations. It would normally be assumed that all (alike) aircraft in a swathe, whether assigned to the backbone or the dispersed subtracks, follow the backbone track profile.

Beyond the ANP database, which provides default information on procedural steps, the aircraft operators are the best source of reliable information, i.e. the procedures they use and the typical weights flown. For individual flights, the 'gold standard' source is the aircraft flight data recorder (FDR) from which all relevant information can be obtained. But even if such data are available, the pre-processing task is formidable. Thus, and in keeping with the necessary modelling economies, the normal practical solution is to make educated assumptions about mean weights and operating procedures.

Caution must be exercised before adopting *default* procedural steps provided in the ANP database (customarily assumed when actual procedures are not known). These are standardised procedures that are widely followed but which may or may not be used by operators in particular cases. A major factor is the definition of take-off (and sometimes climb) engine thrust that can depend to an extent on prevailing circumstances. In particular, it is common practice to reduce thrust levels during departure (from maximum available) in order to extend engine life. **Appendix B** gives guidance on representing typical practice; this will generally produce more realistic contours than a full thrust assumption. However, if, for example, runways are short and/or average air temperatures are high, full thrust is likely to be a more realistic assumption.

When modelling actual scenarios, improved accuracy can be achieved by using radar data to supplement or replace this nominal information. Flight profiles can be determined from radar data in a similar way to the lateral backbone tracks — but only after segregating the traffic by aircraft type and variant and sometimes by weight or stage length (but not by dispersion) — to yield for each sub-group a mean profile of height and speed against ground distance travelled. Again, when merging with the ground tracks subsequently, this single profile is normally assigned to the backbone and subtracks alike.

Knowing the aircraft weight, the variation of speed and propulsive thrust can be calculated via step-by-step solution of the equations of motion. Before doing so it is helpful to pre-process the data to minimise the effects

of radar errors which can make acceleration estimates unreliable. The first step in each case is to redefine the profile by fitting straight line segments to represent the relevant stages of flight; with each segment being appropriately classified; i.e. as a ground roll, constant speed climb or descent, thrust cutback, or acceleration/deceleration with or without flap change. The aircraft weight and atmospheric state are also required inputs.

Section 2.7.11 makes it clear that special provision has to be made to account for the lateral dispersion of flight tracks about the nominal or backbone routings. Radar data samples are characterised by similar dispersions of flight paths in the vertical plane. However it is not usual practice to model vertical dispersion as an independent variable; it arises mainly due to differences in aircraft weights and operating procedures that are taken into account when pre-processing traffic input data.

2.7.13. Construction of flight path segments

Each flight path has to be defined by a set of segment coordinates (nodes) and flight parameters. The starting point is to determine the coordinates of the ground track segments. The flight profile is then calculated, remembering that for a given set of procedural steps, the profile depends on the ground track; e.g. at the same thrust and speed the aircraft climb rate is less in turns than in straight flight. Finally the 3-D flight path segments are constructed by merging the 2-D flight profile with the 2-D ground track ⁽¹⁾.

Ground track

A ground track, whether a backbone track or a dispersed sub-track, is defined by a series of (x,y) coordinates in the ground plane (e.g. from radar information) or by a sequence of vectoring commands describing straight segments and circular arcs (turns of defined radius r and change of heading $\Delta\xi$).

For segmentation modelling, an arc is represented by a sequence of straight segments fitted to sub-arcs. Although they do not appear explicitly in the ground-track segments, the banking of aircraft during turns influences their definition. **Appendix B4** explains how to calculate bank angles during a steady turn but of course these are not actually applied or removed instantaneously. How to handle the transitions between straight and turning flight, or between one turn and an immediately sequential one, is not prescribed. As a rule, the details, which are left to the user (see Section 2.7.11), are likely to have a negligible effect on the final contours; the requirement is mainly to avoid sharp discontinuities at the ends of the turn and this can be achieved simply, for example, by inserting short transition segments over which the bank angle changes linearly with distance. Only in the special case that a particular turn is likely to have a dominating effect on the final contours would it be necessary to model the dynamics of the transition more realistically, to relate bank angle to particular aircraft types and to adopt appropriate roll rates. Here it is sufficient to state that the end sub-arcs $\Delta\xi_{\text{trans}}$ in any turn are dictated by bank angle change requirements. The remainder of the arc with change of heading $\Delta\xi - 2 \cdot \Delta\xi_{\text{trans}}$ degrees is divided into n_{sub} sub-arcs according to the equation:

$$n_{\text{sub}} = \text{int}(1 + (\Delta\xi - 2 \cdot \Delta\xi_{\text{trans}})/30) \quad (2.7.3)$$

where $\text{int}(x)$ is a function that returns the integer part of x . Then the change of heading $\Delta\xi_{\text{sub}}$ of each sub-arc is computed as

$$\Delta\xi_{\text{sub}} = (\Delta\xi - 2 \cdot \Delta\xi_{\text{trans}})/n_{\text{sub}} \quad (2.7.4)$$

where n_{sub} needs to be large enough to ensure that $\Delta\xi_{\text{sub}} \leq 30$ degrees. The segmentation of an arc (excluding the terminating transition sub-segments) is illustrated in **Figure 2.7.f** ⁽²⁾.

⁽¹⁾ For this purpose the total length of the ground track should always exceed that of the flight profile. This can be achieved, if necessary, by adding straight segments of suitable length to the last segment of the ground track.

⁽²⁾ Defined in this simple way, the total length of the segmented path is slightly less than that of the circular path. However the consequent contour error is negligible if the angular increments are below 30°.

Figure 2.7f

Construction of flight path segments dividing turn into segments of length D_s (upper view in horizontal plane, lower view in vertical plane)

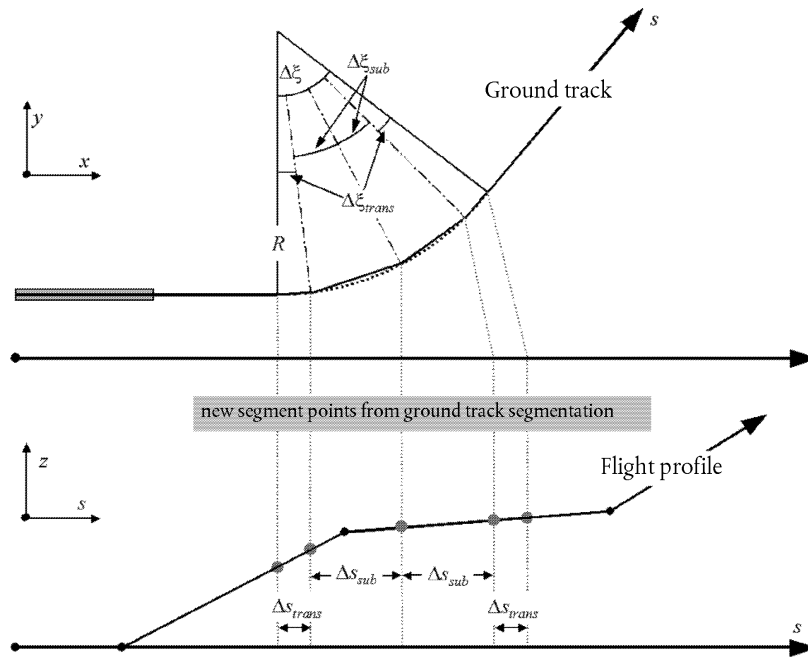

Flight profile

The parameters describing each flight profile segment at the start (suffix 1) and end (suffix 2) of the segment are:

s_1, s_2 distance along the ground track,

z_1, z_2 aeroplane height,

V_1, V_2 groundspeed,

P_1, P_2 noise-related power parameter (matching that for which the NPD-curves are defined), and

ϵ_1, ϵ_2 bank angle.

To build a flight profile from a set of procedural steps (*flight path synthesis*), segments are constructed in sequence to achieve required conditions at the end points. The end-point parameters for each segment become the start-point parameters for the next segment. In any segment calculation the parameters are known at the start; required conditions at the end are specified by the procedural step. The steps themselves are defined either by the ANP defaults or by the user (e.g. from aircraft flight manuals). The end conditions are usually height and speed; the profile building task is to determine the track distance covered in reaching those conditions. The undefined parameters are determined via flight performance calculations described in **Appendix B**.

If the ground track is straight, the profile points and associated flight parameters can be determined independently of the ground track (bank angle is always zero). However ground tracks are rarely straight; they usually incorporate turns and, to achieve best results, these have to be accounted for when determining the 2-dimensional flight profile, where necessary splitting profile segments at ground track nodes to inject changes of bank angle. As a rule the length of the next segment is unknown at the outset and it is calculated provisionally assuming no change of bank angle. If the provisional segment is then found to span one or more ground track nodes, the first being at s , i.e. $s_1 < s < s_2$, the segment is truncated at s , calculating the parameters there by interpolation (see below). These become the end-point parameters of the current segment and the start-point parameters of a new segment — which still has the same target end conditions. If there is no intervening ground track node the provisional segment is confirmed.

If the effects of turns on the flight profile are to be disregarded, the straight flight, single segment solution is adopted although the bank angle information is retained for subsequent use.

Whether or not turn effects are fully modelled, each 3-dimensional flight path is generated by merging its 2-dimensional flight profile with its 2-dimensional ground track. The result is a sequence of coordinate sets (x, y, z), each being either a node of the segmented ground track, a node of the flight profile or both, the profile points being accompanied by the corresponding values of height z , ground speed V , bank angle ε and engine power P . For a track point (x, y) which lies between the end points of a flight profile segment, the flight parameters are interpolated as follows:

$$z = z_1 + f \cdot (z_2 - z_1) \quad (2.7.5)$$

$$V = \sqrt{V_1^2 + f \cdot (V_2^2 - V_1^2)} \quad (2.7.6)$$

$$\varepsilon = \varepsilon_1 + f \cdot (\varepsilon_2 - \varepsilon_1) \quad (2.7.7)$$

$$P = \sqrt{P_1^2 + f \cdot (P_2^2 - P_1^2)} \quad (2.7.8)$$

Where

$$f = (s - s_1)/(s_2 - s_1) \quad (2.7.9)$$

Note that whilst z and ε are assumed to vary linearly with distance, V and P are assumed to vary linearly with time (i.e. constant acceleration ⁽¹⁾).

When matching flight profile segments to radar data (*flight path analysis*) all end-point distances, heights, speeds and bank angles are determined directly from the data; only the power settings have to be calculated using the performance equations. As the ground track and flight profile coordinates can also be matched appropriately, this is usually quite straightforward.

Segmentation of the takeoff ground roll

When taking off, as an aircraft accelerates between the point of brake release (alternatively termed Start-of-Roll SOR) and the point of lift-off, speed changes dramatically over a distance of 1 500 to 2 500 m, from zero to between around 80 and 100 m/s.

⁽¹⁾ Even if engine power settings remain constant along a segment, propulsive force and acceleration can change due to variation of air density with height. However, for the purposes of noise modelling these changes are normally negligible.

The takeoff roll is thus divided into segments with variable lengths over each of which the aircraft speed changes by specific increment ΔV of no more than 10 m/s (about 20 kt). Although it actually varies during the takeoff roll, an assumption of constant acceleration is adequate for this purpose. In this case, for the takeoff phase, V_1 is initial speed, V_2 is the takeoff speed, n_{TO} is the number of takeoff segment and s_{TO} is the equivalent takeoff distance. For equivalent takeoff distance s_{TO} (see **Appendix B**), start speed V_1 and takeoff speed V_2 the number n_{TO} of segments for the ground roll is

$$n_{TO} = \text{int}(1 + (V_2 - V_1)/10) \quad (2.7.10)$$

and hence the change of velocity along a segment is

$$\Delta V = (V_2 - V_1)/n_{TO} \quad (2.7.11)$$

and the time Δt on each segment is (constant acceleration assumed)

$$\Delta t = \frac{2 \cdot s_{TO}}{(V_2 + V_1) \cdot n_{TO}} \quad (2.7.12)$$

The length $s_{TO,k}$ of segment k ($1 \leq k \leq n_{TO}$) of the takeoff roll is then:

$$s_{TO,k} = (k - 0,5) \cdot \Delta V \cdot \Delta t = \frac{(2k - 1) \cdot s_{TO}}{n_{TO}^2} \quad (2.7.13)$$

Example:

For a takeoff distance $s_{TO} = 1\,600$ m, $V_1 = 0$ m/s and $V_2 = 75$ m/s, this yields $n_{TO} = 8$ segments with lengths ranging from 25 to 375 meters (see **Figure 2.7.g**):

Figure 2.7.g

Segmentation of a takeoff roll (example for 8 segments)

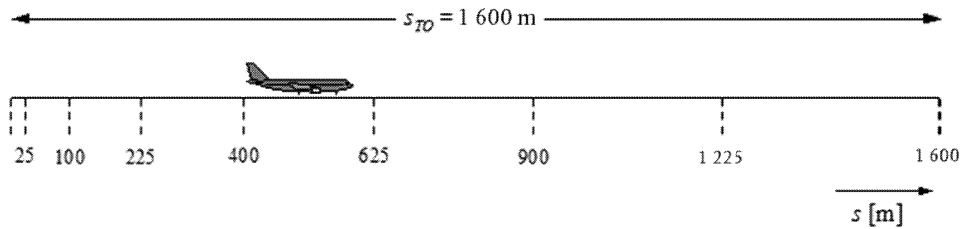

Similarly to the speed changes, the aircraft thrust changes over each segment by a constant increment ΔP , calculated as

$$\Delta P = (P_{TO} - P_{mit})/n_{TO} \quad (2.7.14)$$

where P_{TO} and P_{mit} respectively designate the aircraft thrust at the point of lift-off and the aircraft thrust at the start of takeoff roll.

The use of this constant thrust increment (instead of using the quadratic form (equation (2.7.8)) aims at being consistent with the linear relationship between thrust and speed in the case of jet-engine aircraft (eq. B-1).

Segmentation of the initial climb segment

During the initial climb segment the geometry is changing rapidly particularly with respect to observer locations to the side of the flight track, where *beta angle* will change rapidly as the aircraft climbs through this initial segment. Comparisons with very small segment calculations show that a single climb segment results in a poor approximation of noise to the side of the flight track for integrated metrics. Calculation accuracy is improved by sub-segmenting the first lift-off segment. The length of each segment and number is strongly influenced by lateral attenuation. Noting the expression of total lateral attenuation for aircraft with fuselage-mounted engines, it can be shown that for a limiting change in lateral attenuation of 1,5 dB per sub-segment, that the initial climb segment shall be sub-segmented based on the following set of height values:

$$z = \{18,9, 41,5, 68,3, 102,1, 147,5, 214,9, 334,9, 609,6, 1\ 0289,6\} \text{ metres, or}$$

$$z = \{62, 136, 224, 335, 484, 705, 1\ 099, 2\ 000, 4\ 231\} \text{ feet}$$

The above heights are implemented by identifying which height in the set above is closest to the original segment endpoint. The actual sub-segment heights would then be calculated using:

$$z'_i = z [z_i/z_N] \quad (i = 1 \dots N) \quad (2.7.15)$$

where z is the original segment end height, z_i is the i th member of the set of height values and z_N is the closest upper bound to height z . This process results in the lateral attenuation change across each sub-segment remaining constant, producing more accurate contours, but without the expense of using very short segments.

Example:

If the original segment endpoint height is at $z = 304,8$ m, then from the set of height values, $214,9 < 304,8 < 334,9$ and the closest upper bound is to $z = 304,8$ m is $z_7 = 334,9$ m. The sub-segment endpoint heights are then computed by:

$$z'_i = 304,8 [z_i/334,9] \quad (i = 1..N)$$

Thus z'_1 would be 17,2 m and z'_2 would be 37,8 m, etc.

The speed and engine power values on the inserted points are interpolated using respectively equations (2.7.11) and (2.7.13)

Segmentation of airborne segments

After the segmented flight path has been derived according to the procedure described in Section 2.7.13 and the sub-segmenting described is applied, further segmentation adjustments may be necessary. These include

— the removal of flight path points which are too close together and

— the insertion of additional points when speed changes along segments are too long.

When adjacent points are within 10 metres of each other, and when the associated speeds and thrusts are the same, one of the points shall be eliminated.

For airborne segments where there is a significant speed change along a segment, this shall be subdivided as for the ground roll, i.e.

$$n_{\text{seg}} = \text{int}(1 + |V_2 - V_1|/10) \quad (2.7.16)$$

where V_1 and V_2 are the segment start and end speeds respectively. The corresponding sub-segment parameters are calculated in a similar manner as for the takeoff ground roll, using equations (2.7.11) to (2.7.13).

The landing ground roll

Although the landing ground roll is essentially a reversal of the takeoff ground roll, special account has to be taken of

- *reverse thrust* which is sometimes applied to decelerate the aircraft and
- aeroplanes leaving the runway after deceleration (aircraft that leave the runway no longer contribute to air noise as noise from taxiing is disregarded).

In contrast to the takeoff roll distance, which is derived from aircraft performance parameters, the stop distance s_{stop} (i.e. the distance from touchdown to the point where the aircraft leaves the runway) is not purely aircraft specific. Although a minimum stop distance can be estimated from aircraft mass and performance (and available reverse thrust), the actual stop distance depends also on the location of the taxiways, on the traffic situation, and on airport-specific regulations on the use of reverse thrust.

The use of reverse thrust is not a standard procedure — it is only applied if the needed deceleration cannot be achieved by the use of the wheel brakes. (Reverse thrust can be exceptionally disturbing as a rapid change of engine power from idle to reverse settings produces a sudden burst of noise.)

However, most runways are used for departures as well as for landings so that reverse thrust has a very small effect on the noise contours since the total sound energy in the vicinity of the runway is dominated by the noise produced from takeoff operations. Reverse thrust contributions to contours may only be significant when runway use is limited to landing operations.

Physically, reverse thrust noise is a very complex process but because of its relatively minor significance to air noise contours it can be modelled simplistically — the rapid change in engine power being taken into account by suitable segmentation.

It is clear that modelling the landing ground roll is less straightforward than for takeoff roll noise. The following simplified modelling assumptions are recommended for general use, when no detailed information is available (see **Figure 2.7.h**).

Figure 2.7.h

Modelling of landing ground roll

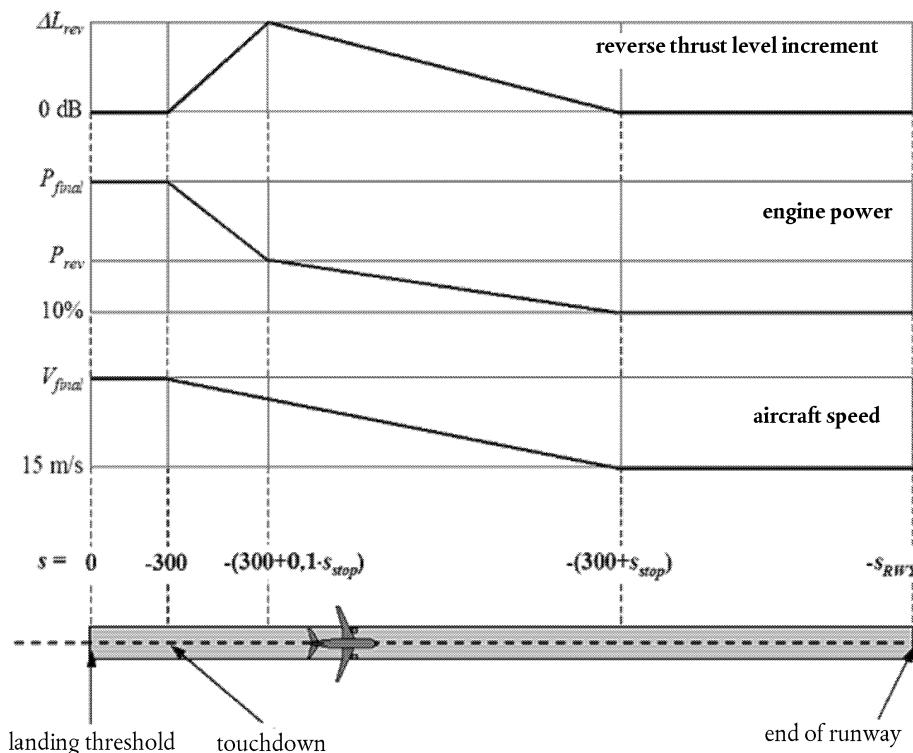

The aeroplane touches down 300 meters beyond the landing threshold (which has the coordinate $s = 0$ along the approach ground track). The aircraft is then decelerated over a stop-distance s_{stop} — aircraft specific values of which are given in the ANP database — from final approach speed V_{final} to 15 m/s. Because of the rapid changes in speed during this segment it shall be sub-segmented in the same manner as for the takeoff ground roll (or airborne segments with rapid speed changes), using equations (2.7.10) to (2.7.13).

The engine power changes from final approach power at touchdown to a reverse thrust power setting P_{rev} over a distance $0,1 \cdot s_{stop}$, then decreases to 10 % of the maximum available power over the remaining 90 percent of the stop distance. Up to the end of the runway (at $s = -s_{RWY}$) aircraft speed remains constant.

NPD curves for reverse thrust are not at present included in the ANP database, and it is therefore necessary to rely on the conventional curves for modelling this effect. Typically the reverse thrust power P_{rev} is around 20 % of the full power setting and this is recommended when no operational information is available. However, at a given power setting, reverse thrust tends to generate significantly more noise than forward thrust and an increment ΔL shall be applied to the NPD-derived event level, increasing from zero to a value ΔL_{rev} (5 dB is recommended provisionally ⁽¹⁾) along $0,1 \cdot s_{stop}$ and then falling linearly to zero along the remainder of the stop distance.

2.7.14. Noise calculation for a single event

The core of the modelling process, described here in full, is the calculation of the event noise level from the flight path information described in **Sections 2.7.7 to 2.7.13**.

⁽¹⁾ This was recommended in the previous edition of ECAC Doc 29 but is still considered provisional pending the acquisition of further corroborative experimental data.

2.7.15. *Single event metrics*

The sound generated by an aircraft movement at the observer location is expressed as a 'single event sound (or noise) level', a quantity which is an indicator of its impact on people. The received sound is measured in noise terms using a basic decibel scale $L(t)$ which applies a frequency weighting (or filter) to mimic a characteristic of human hearing. The scale of most importance in aircraft noise contour modelling is A-weighted sound level, L_A .

The metric most commonly used to encapsulate entire events is 'single event sound (or noise) exposure levels', L_E , which account for all (or most of) the sound energy in the events. Making provisions for the time integration that this involves gives rise to the main complexities of segmentation (or simulation) modelling. Simpler to model is an alternative metric L_{max} which is the maximum instantaneous level occurring during the event; however it is L_E which is the basic building block of most modern aircraft noise indices and practical models can in future be expected to embody both L_{max} and L_E . Either metric can be measured on different scales of noise; in this document only A-weighted sound level is considered. Symbolically, the scale is usually indicated by extending the metric suffix, i.e. L_{AE} , L_{Amax} .

The single event sound (or noise) exposure level is expressed exactly as

$$L_E = 10 \cdot \lg \left(\frac{1}{t_0} \int_{t_1}^{t_2} 10^{L(t)/10} dt \right) \quad (2.7.17)$$

where t_0 denotes a reference time. The integration interval $[t_1, t_2]$ is chosen to ensure that (nearly) all significant sound in the event is encompassed. Very often, the limits t_1 and t_2 are chosen to span the period for which the level $L(t)$ is within 10 dB of L_{max} . This period is known as the '10-dB down' time. Sound (noise) exposure levels tabulated in the ANP database are 10-dB down values ⁽¹⁾.

For aircraft noise contour modelling, the main application of equation (2.7.17) is the standard metric *Sound Exposure Level* L_{AE} (acronym SEL):

$$L_{AE} = 10 \cdot \lg \left(\frac{1}{t_0} \int_{t_1}^{t_2} 10^{L_A(t)/10} dt \right) \text{ with } t_0 = 1 \text{ second} \quad (2.7.18)$$

The exposure level equations above can be used to determine event levels when the entire time history of $L(t)$ is known. Within the recommended noise modelling methodology such time histories are not defined; event exposure levels are calculated by summing segment values, partial event levels each of which defines the contribution from a single, finite segment of the flight path.

2.7.16. *Determination of event levels from NPD-data*

The principal source of aircraft noise data is the international Aircraft Noise and Performance (ANP) database. This tabulates L_{max} and L_E as functions of propagation distance d — for specific aircraft types, variants, flight configurations (approach, departure, flap settings), and power settings P . They relate to steady flight at specific reference speeds V_{ref} along a notionally infinite, straight flight path ⁽²⁾.

⁽¹⁾ 10dB-down L_E may be up to 0,5 dB lower than L_E evaluated over a longer duration. However, except at short slant distances where event levels are high, extraneous ambient noise often makes longer measurement intervals impractical and 10-dB down values are the norm. As studies of the effects of noise (used to 'calibrate' the noise contours) also tend to rely on 10-dB down values, the ANP tabulations are considered to be entirely appropriate.

⁽²⁾ Although the notion of an infinitely long flight path is important to the definition of event sound exposure level L_E , it has less relevance in the case of event maximum level L_{max} which is governed by the noise emitted by the aircraft when at a particular position at or near its closest point of approach to the observer. For modelling purposes the NPD distance parameter is taken to be the minimum distance between the observer and segment.

How values of the independent variables P and d are specified is described later. In a single look-up, with input values P and d , the output values required are the *baseline levels* $L_{max}(P,d)$ and/or $L_{Evo}(P,d)$ (applicable to an infinite flight path). Unless values happen to be tabulated for P and/or d exactly, it will generally be necessary to estimate the required event noise level(s) by interpolation. A linear interpolation is used between tabulated power-settings, whereas a logarithmic interpolation is used between tabulated distances (see **Figure 2.7.i**).

Figure 2.7.i

Interpolation in noise-power-distance curves

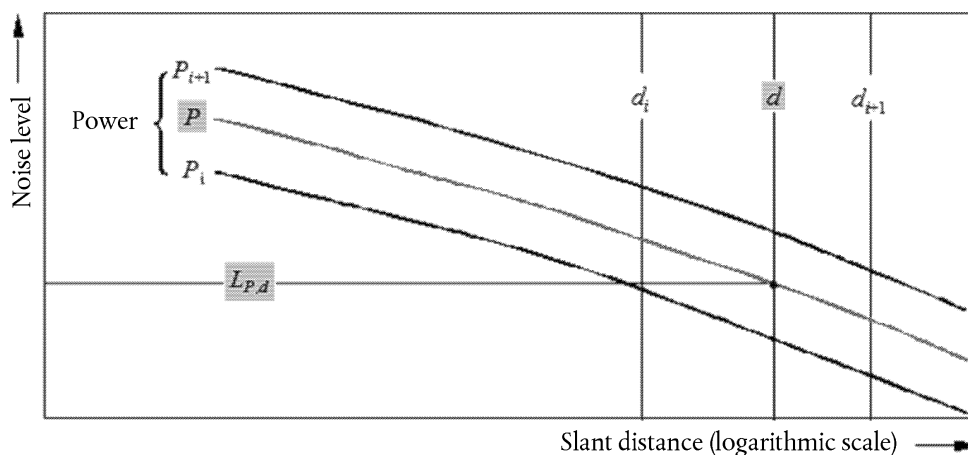

If P_i and P_{i+1} are engine power values for which noise level versus distance data are tabulated, the noise level $L(P)$ at a given distance for intermediate power P , between P_i and P_{i+1} , is given by:

$$L(P) = L(P_i) + \frac{L(P_{i+1}) - L(P_i)}{P_{i+1} - P_i} \cdot (P - P_i) \tag{2.7.19}$$

If, at any power setting, d_i and d_{i+1} are distances for which noise data are tabulated, the noise level $L(d)$ for an intermediate distance d , between d_i and d_{i+1} is given by

$$L(d) = L(d_i) + \frac{L(d_{i+1}) - L(d_i)}{\lg d_{i+1} - \lg d_i} \cdot (\lg d - \lg d_i) \tag{2.7.20}$$

By using equations (2.7.19) and (2.7.20), a noise level $L(P,d)$ can be obtained for any power setting P and any distance d that is within the envelope of the NPD data base.

For distances d that lie outside the NPD envelope, equation (2.7.20) is used to extrapolate from the last two values, i.e. inwards from $L(d_1)$ and $L(d_2)$ or outwards from $L(d_{i-1})$ and $L(d_i)$ where I is the total number of NPD points on the curve. Thus

Inwards:
$$L(d) = L(d_2) + \frac{L(d_1) - L(d_2)}{\lg d_2 - \lg d_1} \cdot (\lg d_2 - \lg d) \tag{2.7.21}$$

Outwards:
$$L(d) = L(d_{i-1}) - \frac{L(d_{i-1}) - L(d_i)}{\lg d_i - \lg d_{i-1}} \cdot (\lg d - \lg d_{i-1}) \tag{2.7.22}$$

As, at short distances d , noise levels increase very rapidly with decreasing propagation distance, it is recommended that a lower limit of 30 m be imposed on d , i.e. $d = \max(d, 30 \text{ m})$.

Impedance adjustment of standard NPD data

The NPD data provided in the ANP database are normalised to specific atmospheric conditions (temperature of 25 °C and pressure of 101,325 kPa). Before applying the interpolation/extrapolation method previously described, an acoustic impedance adjustment shall be applied to these standard NPD data.

Acoustic impedance is related to the propagation of sound waves in an acoustic medium, and is defined as the product of the density of air and the speed of sound. For a given sound intensity (power per unit area) perceived at a specific distance from the source, the associated sound pressure (used to define SEL and L_{Amax} metrics) depends on the acoustic impedance of the air at the measurement location. It is a function of temperature, atmospheric pressure (and indirectly altitude). There is therefore a need to adjust the standard NPD data of the ANP database to account for the actual temperature and pressure conditions at the receiver point, which are generally different from the normalised conditions of the ANP data.

The impedance adjustment to be applied to the standard NPD levels is expressed as follows:

$$\Delta_{Impedance} = 10 \cdot \lg \left(\frac{\rho \cdot c}{409,81} \right) \quad (2.7.23)$$

where:

$\Delta_{Impedance}$	Impedance adjustment for the actual atmospheric conditions at the receiver point (dB)
$\rho \cdot c$	Acoustic impedance (newton · seconds/m ³) of the air at the receiver point (409,81 being the air impedance associated to the reference atmospheric conditions of the NPD data in the ANP database).

Impedance $\rho \cdot c$ is calculated as follows:

$$\rho \cdot c = 416,86 \cdot \left[\frac{\delta}{\vartheta^{1/2}} \right] \quad (2.7.24)$$

δ	p/p_o , the ratio of the ambient air pressure at the observer altitude to the standard air pressure at mean sea level: $p_o = 101,325$ kPa (or 1013,25 mb)
ϑ	$(T + 273,15)/(T_o + 273,15)$ the ratio of the air temperature at the observer altitude to the standard air temperature at mean sea level: $T_o = 15,0$ °C

The acoustic impedance adjustment is usually less than a few tenths of one dB. In particular, it should be noted that under the standard atmospheric conditions ($p_o = 101,325$ kPa and $T_o = 15,0$ °C), the impedance adjustment is less than 0,1 dB (0,074 dB). However, when there is a significant variation in temperature and atmospheric pressure relative to the reference atmospheric conditions of the NPD data, the adjustment can be more substantial.

2.7.17. General expressions

Segment event level L_{seg}

The segment values are determined by applying adjustments to the baseline (infinite path) values read from the NPD data. The maximum noise level from one flight path segment $L_{max,seg}$ can be expressed in general as

$$L_{max,seg} = L_{max}(P, d) + \Delta_I(\varphi) - \Lambda(\beta, \ell) \quad (2.7.25)$$

and the contribution from one flight path segment to L_E as

$$L_{E,seg} = L_{E\infty}(P, d) + \Delta_V + \Delta_I(\varphi) - \Lambda(\beta, \ell) + \Delta_F \quad (2.7.26)$$

The 'correction terms' in equations (2.7.25) and (2.7.26) — which are described in detail in Section 2.7.19 — account for the following effects:

- Δ_V *Duration correction*: the NPD data relate to a reference flight speed. This adjusts exposure levels to non-reference speeds. (It is not applied to $L_{max,seg}$.)
- $\Delta_I(\varphi)$ *Installation effect*: describes a variation in *lateral directivity* due to shielding, refraction and reflection caused by the airframe, engines and surrounding flow fields.
- $\Lambda(\beta, \ell)$ *Lateral attenuation*: significant for sound propagating at low angles to the ground, this accounts for the interaction between direct and reflected sound waves (ground effect) and for the effects of atmospheric non-uniformities (primarily caused by the ground) that refract sound waves as they travel towards the observer to the side of the flight path.
- Δ_F *Finite segment correction (noise fraction)*: accounts for the finite length of the segment which obviously contributes less noise exposure than an infinite one. It is only applied to exposure metrics.

If the segment is part of the take-off or landing ground roll and the observer is located behind the segment under consideration, special steps are taken to represent the pronounced directionality of jet engine noise that is observed behind an aircraft about to takeoff. These special steps result in particular in the use of a particular form of the noise for the exposure level:

$$L_{max,seg} = L_{max}(P, d) + \Delta_I(\varphi) - \Lambda(\beta, \ell) + \Delta_{SOR} \quad (2.7.27)$$

$$L_{E,seg} = L_{E\infty}(P, d) + \Delta_V + \Delta_I(\varphi) - \Lambda(\beta, \ell) + \Delta'_F + \Delta_{SOR} \quad (2.7.28)$$

- Δ'_F Particular form of the *Segment correction*
- Δ_{SOR} *Directivity correction*: accounts for the pronounced directionality of jet engine noise behind the ground roll segment

The specific treatment of ground roll segments is described in Section 2.7.19.

Sections below describe the calculation of segment noise levels.

Event noise level L of an aircraft movement

Maximum level L_{max} is simply the greatest of the segment values $L_{max,seg}$ (see equations (2.7.25) and (2.7.27))

$$L_{max} = \max(L_{max,seg}) \quad (2.7.29)$$

where each segment value is determined from the aircraft NPD data for power P and distance d . These parameters and the modifier terms $\Delta_I(\varphi)$ and $\Lambda(\beta, \ell)$ are explained below.

Exposure level L_E is calculated as the decibel sum of the contributions $L_{E,seg}$ from each noise-significant segment of its flight path; i.e.

$$L_E = 10 \cdot \lg\left(\sum 10^{L_{E,seg}/10}\right) \quad (2.7.30)$$

The summation proceeds step by step through the flight path segments.

The remainder of this chapter is concerned with the determination of the segment noise levels $L_{\max, \text{seg}}$ and $L_{E, \text{seg}}$.

2.7.18. *Flight path segment parameters*

The power P , and distance d , for which the baseline levels $L_{\max, \text{seg}}(P, d)$ and $L_{E, \text{seg}}(P, d)$ are interpolated from the NPD tables, are determined from geometric and operational parameters that define the segment. How this is done is explained below with the aid of illustrations of the plane containing the segment and the observer.

Geometric parameters

Figures 2.7.j to 2.7.l show the source-receiver geometries when the observer O is (a) behind, (b) alongside and (c) ahead of the segment S_1S_2 where the flight direction is from S_1 to S_2 . In these diagrams

- O is the observer location
- S_1, S_2 are the start and end of the segment
- S_p is the point of perpendicular closest approach to the observer on the segment or its extension
- d_1, d_2 are the distances between start, end of segment and observer
- d_s is the shortest distance between observer and segment
- d_p is the perpendicular distance between observer and extended segment (*minimum slant range*)
- λ is the length of flight path segment
- q is the distance from S_1 to S_p (negative if the observer position is behind the segment)

Figure 2.7.j

Flight path segment geometry for observer behind segment

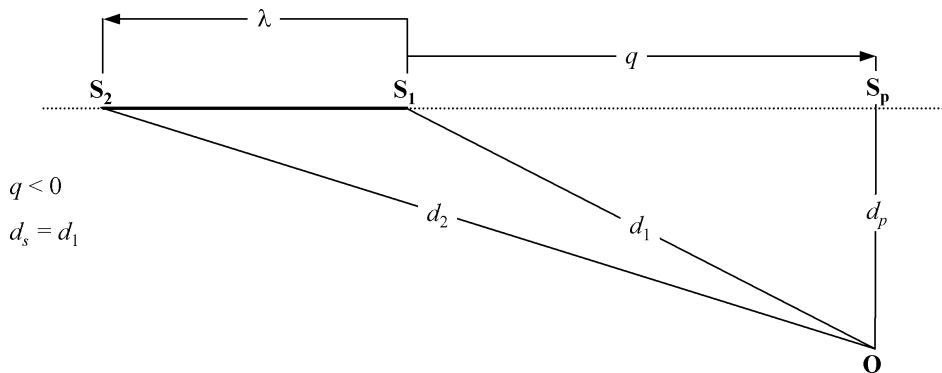

Figure 2.7.k

Flight path segment geometry for observer alongside segment

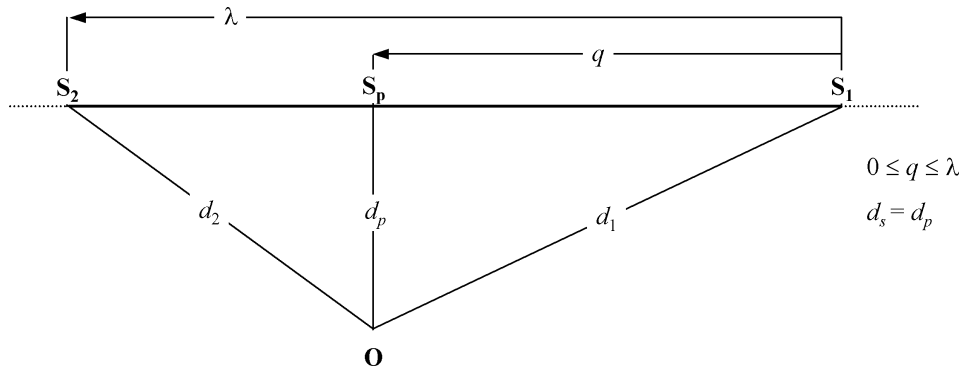
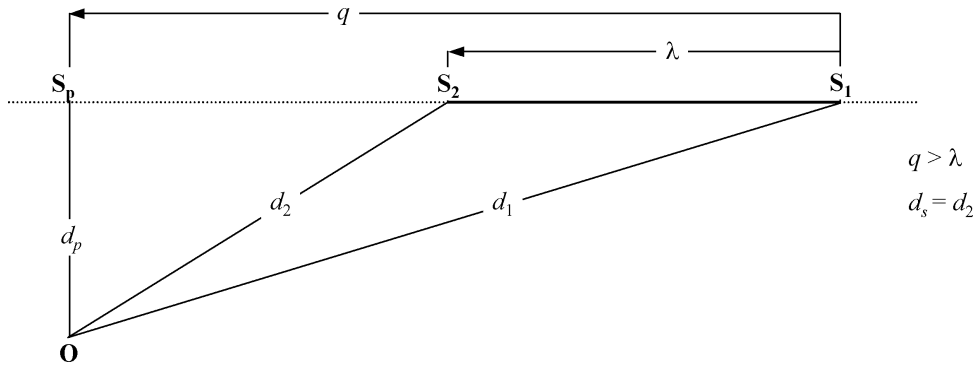

Figure 2.7.l

Flight path segment geometry for observer ahead of segment



The flight path segment is represented by a bold, solid line. The dotted line represents the *flight path extension* which stretches to infinity in both directions. For airborne segments, when the event metric is an exposure level L_E , the NPD distance parameter d is the distance d_p between S_p and the observer, called the *minimum slant range* (i.e. the perpendicular distance from the observer to the segment or its extension, in other words to the (hypothetical) infinite flight path of which the segment is considered to be part).

However, for exposure level metrics where observer locations are behind the ground segments during the takeoff roll and locations ahead of ground segments during the landing roll, the NPD distance parameter d becomes the distance d_s , the shortest distance from the observer to the segment (i.e. the same as for maximum level metrics).

For maximum level metrics, the NPD distance parameter d is d_s , the shortest distance from the observer to the segment.

Segment power P

The tabulated NPD data describe the noise of an aircraft in steady straight flight on an infinite flight path, i.e. at constant engine power P . The recommended methodology breaks actual flight paths, along which speed and direction vary, into a number of finite segments, each of which is then taken to be part of a uniform, infinite flight path for which the NPD data are valid. But the methodology provides for changes of power along the length of a segment; it is taken to change linearly with distance from P_1 at its start to P_2 at its end. It is therefore necessary to define an equivalent steady segment value P . This is taken to be the value at the point on the segment that is closest to the observer. If the observer is alongside the segment (Figure 2.7.k) it is obtained by interpolation as given by equation (2.7.8) between the end values, i.e.

$$P = \sqrt{P_1^2 + \frac{q}{\lambda} \cdot (P_2^2 - P_1^2)} \quad (2.7.31)$$

If the observer is behind or ahead of the segment, it is that at the nearest end point, P_1 or P_2 .

2.7.19. Segment Event level correction terms

The NPD data define noise event levels as a function of distance perpendicularly beneath an idealised straight level path of infinite length along which the aircraft flies with steady power at a fixed reference speed ⁽¹⁾. The event level interpolated from the NPD table for a specific power setting and slant distance is thus described as a *baseline level*. It applies to an infinite flight path and has to be corrected to account for the effects of (1) non-reference speed, (2) engine installation effects (lateral directivity), (3) lateral attenuation, (4) finite segment length and (5) longitudinal directivity behind start of roll on takeoff — see equations (2.7.25) and (2.7.26).

The duration correction DV (Exposure levels LE only)

This correction ⁽²⁾ accounts for a change in exposure levels if the actual segment groundspeed is different to the aircraft reference speed V_{ref} to which the basic NPD-data relate. Like engine power, speed varies along the segment (groundspeed varies from V_1 to V_2) and it is necessary to define an equivalent segment speed V_{seg} remembering that the segment is inclined to the ground; i.e.

$$V_{seg} = V/\cos\gamma \quad (2.7.32)$$

where here V is an equivalent segment groundspeed (for information, see equation B-22 which expresses V in terms of calibrated airspeed, V_c and

$$\gamma = \tan^{-1} \left(\frac{z_2 - z_1}{s_2 - s_1} \right) \quad (2.7.33)$$

For airborne segments, V is taken to be the groundspeed at the closest point of approach **S** — interpolated between the segment end-point values assuming it varies linearly with time; i.e. if the observer is alongside the segment:

$$V = \sqrt{V_1^2 + \frac{q}{\lambda} \cdot (V_2^2 - V_1^2)} \quad (2.7.34)$$

⁽¹⁾ NPD specifications require that the data be based on measurements of steady *straight* flight, not necessarily level; to create the necessary flight conditions, the test aircraft flight path can be inclined to the horizontal. However, as will be seen, inclined paths lead to computational difficulties and, when using the data for modelling, it is convenient to visualise the source paths as being both straight and level.

⁽²⁾ This is known as the *duration correction* because it makes allowance for the effects of aircraft *speed* on the duration of the sound event — implementing the simple assumption that, other things being equal, duration, and thus received event sound energy, is inversely proportional to source velocity.

If the observer is behind or ahead of the segment, it is that at the nearest end point, V_1 or V_2 .

For runway segments (parts of the take-off or landing ground rolls for which $\gamma = 0$) V_{seg} is taken to be simply the average of the segment start and end speeds; i.e.

$$V_{seg} = (V_1 + V_2)/2 \tag{2.7.35}$$

In either case the additive duration correction is then

$$\Delta_V = 10 \cdot \lg(V_{ref}/V_{seg}) \tag{2.7.36}$$

Sound propagation geometry

Figure 2.7.1 shows the basic geometry in the plane normal to the aircraft flight path. The ground line is the intersection of the normal plane and the level ground plane. (If the flight path is level the ground line is an end view of the ground plane.) The aircraft is banked at angle ϵ measured counter-clockwise about its roll axis (i.e. starboard wing up). It is therefore positive for left turns and negative for right turns.

Figure 2.7.m

Aircraft-observer angles in plane normal to flight path

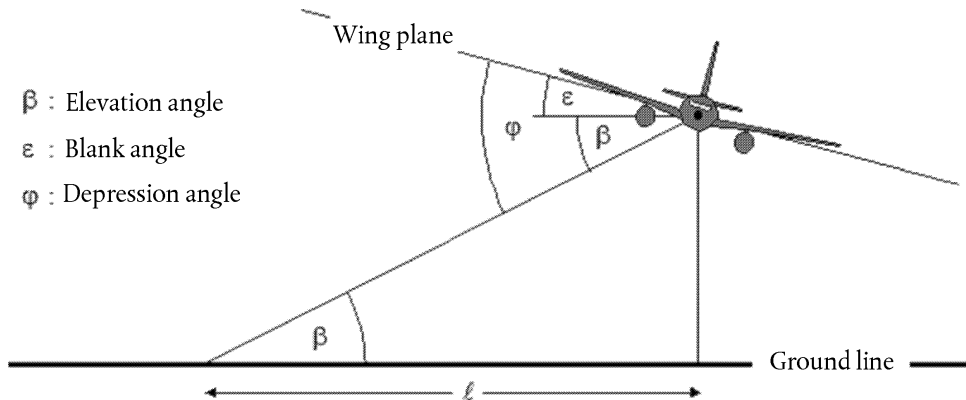

- The *elevation angle* β (between 0 and 90°) between the direct sound propagation path and the level ground line ⁽¹⁾ determines, together with the flight path inclination and the lateral displacement l of the observer from the ground track, the lateral attenuation.
- The *depression angle* ϕ between the wing plane and the propagation path, determines the engine installation effects. With respect to the convention for the bank angle $\phi = \beta \pm \epsilon$ with the sign positive for observers to starboard (right) and negative for observers to port (left).

⁽¹⁾ In the case of non-flat terrain there can be different definitions of elevation angle. Here it is defined by the aircraft height above the observation point and the slant distance — hence neglecting local terrain gradients as well as obstacles on the sound propagation path (see Sections 2.7.6 and 2.7.10). In the event that, due to ground elevation, the receiver point is above the aircraft, elevation angle β is set equal to zero.

Engine installation correction ΔI

An aircraft in flight is a complex sound source. Not only are the engine (and airframe) sources complex in origin, but the airframe configuration, particularly the location of the engines, influences the noise radiation patterns through the processes of reflection, refraction and scattering by the solid surfaces and aerodynamic flow fields. This results in a non-uniform directionality of sound radiated laterally about the roll axis of the aircraft, referred to here as *lateral directivity*.

There are significant differences in lateral directivity between aircraft with fuselage-mounted and underwing-mounted engines and these are allowed for in the following expression:

$$\Delta_l(\varphi) = 10 \cdot \lg \left[\frac{a \cdot \cos^2 \varphi + \sin^2 \varphi}{c \cdot \sin^2 2\varphi + \cos^2 2\varphi} \right] \quad \text{dB} \quad (2.7.37)$$

where $\Delta_l(\varphi)$ is the correction, in dB, at depression angle φ (see **Figure 2.7.m**) and

$a = 0,00384,$	$b = 0,0621,$	$c = 0,8786$	for wing-mounted engines and
$a = 0,1225,$	$b = 0,3290,$	$c = 1$	for fuselage-mounted engines.

For propeller aircraft directivity variations are negligible and for these it may be assumed that

$$\Delta_l(\varphi) = 0 \quad (2.7.38)$$

Figure 2.7.n shows the variation of $\Delta_l(\varphi)$ about the aircraft roll axis for the three engine installations. These empirical relationships have been derived by the SAE from experimental measurements made mainly beneath the wing. Until above-wing data have been analysed it is recommended that, for negative φ , $\Delta_l(\varphi) = \Delta_l(0)$ for all installations.

Figure 2.7.n

Lateral directivity of installation effects

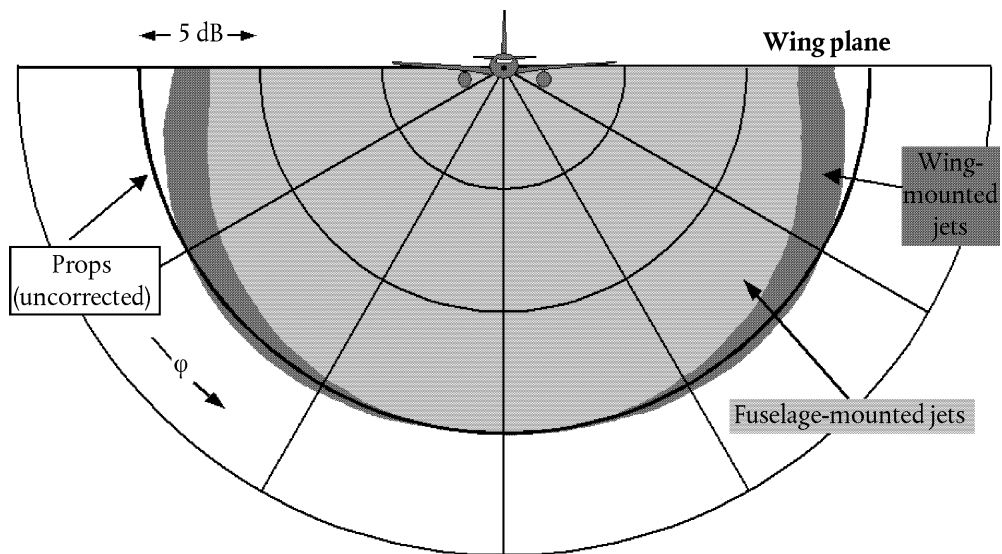

It is assumed that $\Delta_1(\varphi)$ is two-dimensional; i.e. it does not depend on any other parameter — and in particular that it does not vary with the longitudinal distance of the observer from the aircraft. This means that the *elevation angle* β for $\Delta_1(\varphi)$ is defined as $\beta = \tan^{-1}(z/\ell)$. This is for modelling convenience until there is a better understanding of the mechanisms; in reality, installation effects are bound to be substantially three-dimensional. Despite that, a two-dimensional model is justified by the fact that event levels tend to be dominated by noise radiated sideways from the nearest segment.

Lateral attenuation $\Lambda(\beta, \ell)$ (infinite flight path)

Tabulated NPD event levels relate to steady level flight and are generally based on measurements made 1,2 m over soft level ground beneath the aircraft; the distance parameter is effectively height above the surface. Any effect of the surface on event noise levels beneath the aircraft, that might cause the tabulated levels to differ from free-field values ⁽¹⁾, is assumed to be inherent in the data (i.e. in the shape of the level vs. distance relationships).

To the side of the flight path, the distance parameter is the minimum slant distance — the length of the normal from the receiver to the flight path. At any lateral position the noise level will generally be less than at the same distance immediately below the aircraft. Apart from *lateral directivity* or 'installation effects' described above is due to an excess *lateral attenuation* which causes the sound level to fall more rapidly with distance than indicated by the NPD curves. A previous, widely used method for modelling lateral propagation of aircraft noise was developed by the Society of Automotive Engineers (SAE) in AIR-1751 and the algorithms described below are based on improvements SAE now recommends AIR-5662. Lateral attenuation is a reflection effect, due to interference between directly radiated sound and that which reflects from the surface. It depends on the nature of the surface and can cause significant reductions in observed sound levels at low elevation angles. It is also very strongly affected by sound refraction, steady and unsteady, caused by wind and temperature gradients and turbulence which are themselves attributable to the presence of the surface ⁽²⁾. The mechanism of surface reflection is well understood and, for uniform atmospheric and surface conditions, it can be described theoretically with some precision. However, atmospheric and surface non-uniformities — which are not amenable to simple theoretical analysis — have a profound effect on the reflection effect, tending to 'spread' it to higher elevation angles; thus the theory is of limited applicability. SAE work to develop a better understanding of surface effects is continuing and this is expected to lead to better models. Until these are developed, the following methodology, described in AIR-5662, is recommended for calculating lateral attenuation. It is confined to the case of sound propagation over soft level ground which is appropriate for the great majority of civil airports. Adjustments to account for the effects of a hard ground surface (or, acoustically equivalent, water) are still under development.

The methodology is built on the substantial body of experimental data on sound propagation from aircraft with fuselage-mounted engines in straight (non-turning), steady, level flight reported originally in AIR-1751. Making the assumption that, for level flight, air-to-ground attenuation depends on (i) elevation angle β measured in the vertical plane and (ii) lateral displacement from the aircraft ground track ℓ , the data were analysed to obtain an empirical function for the *total lateral adjustment* $\Lambda_T(\beta, \ell)$ (= lateral event level minus the level at the same distance beneath the aircraft).

As the term $\Lambda_T(\beta, \ell)$ accounted for lateral directivity as well as lateral attenuation, the latter can be extracted by subtraction. Describing lateral directivity by equation (2.7.37), with the fuselage-mount coefficients and with φ replaced by β (appropriate to non-turning flight), the lateral attenuation becomes:

$$\Lambda(\beta, \ell) = \Lambda_T(\beta, \ell) - \Delta_1(\beta) \quad (2.7.39)$$

where β and ℓ are measured as depicted in **Figure 2.7.m** in a plane normal to the infinite flight path which, for level flight, is also vertical.

⁽¹⁾ A 'free-field' level is that which would be observed if the ground surface were not there.

⁽²⁾ The wind and temperature gradients and turbulence depend in part upon the roughness and heat transfer characteristics of the surface.

Although $\Lambda(\beta, \ell)$ could be calculated directly using equation (2.7.39) with $\Lambda_r(\beta, \ell)$ taken from AIR-1751, a more efficient relationship is recommended. This is the following empirical approximation adapted from AIR-5662:

$$\Lambda(\beta, \ell) = \Gamma(\ell) \cdot \Lambda(\beta) \tag{2.7.40}$$

where $\Gamma(\ell)$ is a distance factor given by

$$\Gamma(\ell) = 1.089 \cdot [1 - \exp(-0.00274\ell)] \quad \text{for } 0 \leq \ell \leq 914 \text{ m} \tag{2.7.41}$$

$$\Gamma(\ell) = 1 \quad \text{for } \ell > 914 \text{ m} \tag{2.7.42}$$

and $\Lambda(\beta)$ is long-range air-to-ground lateral attenuation given by

$$\Lambda(\beta) = 1,137 - 0,0229\beta + 9,72 \cdot \exp(-0,142\beta) \quad \text{for } 0^\circ \leq \beta \leq 50^\circ \tag{2.7.43}$$

$$\Lambda(\beta) = 0 \quad \text{for } 50^\circ \leq \beta \leq 90^\circ \tag{2.7.44}$$

The expression for lateral attenuation $\Lambda(\beta, \ell)$, equation (2.7.40), which is assumed to hold good for all aircraft, propeller aircraft as well as fuselage-mount and wing-mount jets, is shown graphically in **Figure 2.7.o**.

Under certain circumstances (with terrain), it is possible for β to be less than zero. In such cases it is recommended that $\Lambda(\beta) = 10,57$.

Figure 2.7.o

Variation of lateral attenuation $\Lambda(\beta, \ell)$ with elevation angle and distance

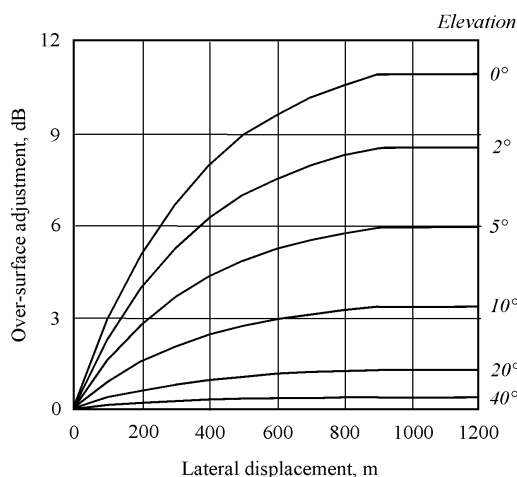

Finite segment lateral attenuation

Equations (2.7.41) to (2.7.44) describe the lateral attenuation $\Lambda(\beta, \ell)$ of sound arriving at the observer from an aeroplane in steady flight along an infinite, level flight path. When applying them to finite path segments that are not level, the attenuation has to be calculated for an *equivalent* level path — as the closest point on a simple extension of the inclined segment (that passes through the ground surface at some point) generally does not yield an appropriate elevation angle β .

The determination of lateral attenuation for finite segments differs markedly for L_{max} and L_E metrics. Segment maximum levels L_{max} are determined from NPD data as a function of propagation distance d from the nearest point on the segment; no corrections are required to account for the dimensions of the segment. Likewise, lateral attenuation of L_{max} is assumed to depend only on the elevation angle of, and ground distance to, the same point. Thus only the coordinates of that point are required. But for L_E , the process is more complicated.

The baseline event level $L_E(P,d)$ that is determined from the NPD data, even though for finite segment parameters, applies nevertheless to an infinite flight path. The event exposure level from a segment, $L_{E,seg}$, is of course less than the baseline level — by the amount of the finite segment correction defined later in Section 2.7.19. That correction, a function of the geometry of triangles OS_1S_2 in **Figures 2.7.j to 2.7.l**, defines what proportion of the total infinite path noise energy received at O comes from the segment; the same correction applies, whether or not there is any lateral attenuation. But any lateral attenuation shall be calculated for the infinite flight path, i.e. as a function of its displacement and elevation, not those of the finite segment.

Adding the corrections Δ_v and Δ_p , and subtracting lateral attenuation $\Lambda(\beta,\ell)$ from the NPD *baseline level* gives the adjusted event noise level for equivalent steady *level* flight on an adjacent, infinite straight path. But the actual flight path segments being modelled, those that affect the noise contours, are rarely level; aircraft are usually climbing or descending.

Figure 2.7.p illustrates a departure segment S_1S_2 — the aircraft is climbing at an angle γ — but the considerations remain very similar for an arrival. The remainder of the ‘real’ flight path is not shown; suffice it to state that S_1S_2 represents just a part of the whole path (which in general will be curved). In this case, the observer O is alongside, and to the left of, the segment. The aircraft is banked (anti-clockwise about the flight path) at an angle ε to the lateral horizontal axis. The depression angle φ from the wing plane, of which the installation effect Δ_i is a function (equation (2.7.39)), lies in the plane normal to the flight path in which ε is defined. Thus $\varphi = \beta - \varepsilon$ where $\beta = \tan^{-1}(h/\ell)$ and ℓ is the perpendicular distance OR from the observer to the ground track; i.e. the lateral displacement of the observer (¹). The aeroplane’s closest point of approach to the observer, S , is defined by the perpendicular OS , of length (slant distance) d_p . The triangle OS_1S_2 accords with **Figure 2.7.k**, the geometry for calculating the segment correction Δ_p .

Figure 2.7.p

Observer alongside segment

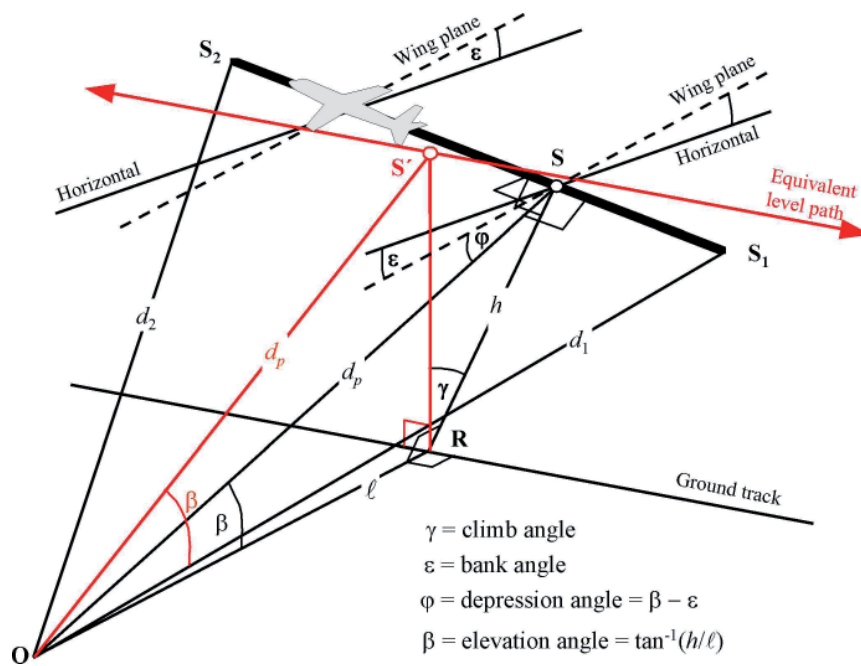

To calculate the lateral attenuation using equation (2.7.40) (where β is measured in a vertical plane), an *equivalent level flight path* is defined in the vertical plane through S_1S_2 and with the same perpendicular slant distance d_p from the observer. This is visualised by rotating the triangle ORS , and its attached flight path about OR (see **Figure 2.7.p**) through angle γ thus forming the triangle ORS' . The elevation angle of this equivalent level path (now in a vertical plane) is $\beta = \tan^{-1}(h/\ell)$ (ℓ remains unchanged). In this case, observer alongside, the lateral attenuation $\Lambda(\beta, \ell)$ is the same for L_E and L_{max} metrics.

⁽¹⁾ For an observer located on the right side to the segment φ would become $\beta + \varepsilon$ (see Section 2.7.19).

Figure 2.7.q illustrates the situation when the observer point O lies behind the finite segment, not alongside. Here the segment is observed as a more distant part of an infinite path; a perpendicular can only be drawn to point S_p on its extension. The triangle OS_1S_2 accords with Figure 2.7.j which defines the segment correction Δ_p . But in this case the parameters for lateral directivity and attenuation are less obvious.

Figure 2.7.q

Observer behind segment

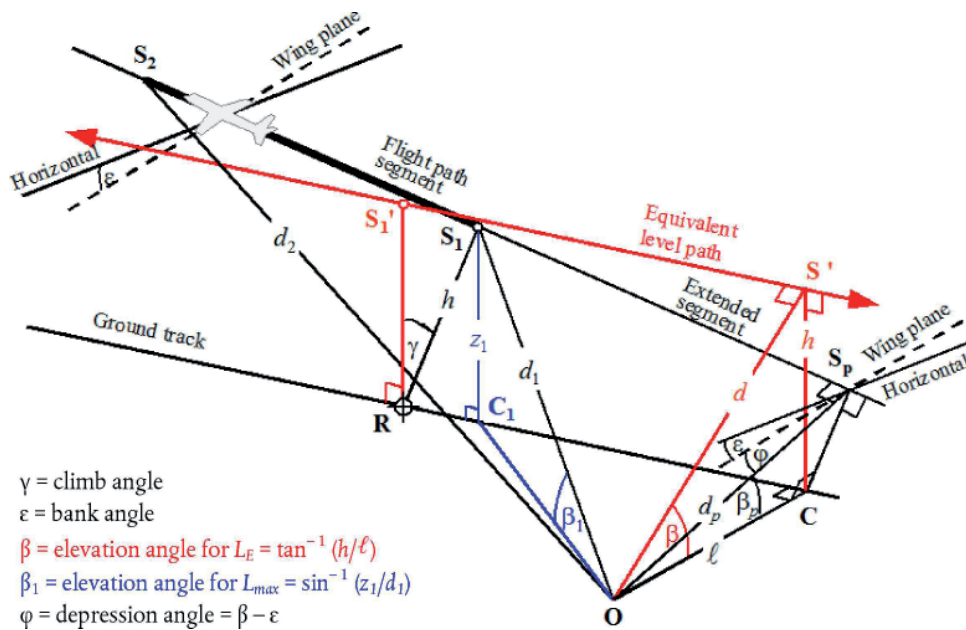

Remembering that, as conceived for modelling purposes, lateral directivity (installation effect) is two-dimensional, the defining depression angle ϕ is still measured laterally from the aircraft wing plane. (The baseline event level is still that generated by the aircraft traversing the infinite flight path represented by the extended segment.) Thus the depression angle is determined at the closest point of approach, i.e. $\phi = \beta_p - \epsilon$ where β_p is angle S_pOC .

For maximum level metrics, the NPD distance parameter is taken as the shortest distance to the segment, i.e. $d = d_1$. For exposure level metrics, it is the shortest distance d_p from O to S_p on the extended flight path; i.e. the level interpolated from the NPD table is $L_{E_{\infty}}(P_1, d_p)$.

The geometrical parameters for lateral attenuation also differ for maximum and exposure level calculations. For maximum level metrics the adjustment $L(\beta, \ell)$ is given by equation (2.7.40) with $\beta = \beta_1 = \sin^{-1}(z_1/d_1)$ and $\ell = OC_1 = \sqrt{d_1^2 - z_1^2}$ where β_1 and d_1 are defined by the triangle OC_1S_1 in the vertical plane through O and S_1 .

When calculating the lateral attenuation for airborne segments only and exposure level metrics, ℓ remains the shortest lateral displacement from the segment extension (OC). But to define an appropriate value of β it is again necessary to visualise an (infinite) equivalent level flight path of which the segment can be considered part. This is drawn through S_1' , height h above the surface, where h is equal to the length of RS_1 the perpendicular from the ground track to the segment. This is equivalent to rotating the actual extended flight path through angle γ about point R (see Figure 2.7.q). Insofar as R is on the perpendicular to S_1 , the point on the segment that is closest to O , the construction of the equivalent level path is the same as when O is alongside the segment.

The closest point of approach of the equivalent level path to the observer \mathbf{O} is at \mathbf{S}' , slant distance d , so that the triangle \mathbf{OCS}' so formed in the vertical plane then defines the elevation angle $\beta = \cos^{-1}(\ell/d)$. Although this transformation might seem rather convoluted, it should be noted that the basic source geometry (defined by d_1 , d , and φ) remains untouched, the sound travelling from the segment *towards* the observer is simply what it would be if the entire flight along the infinitely extended inclined segment (of which for modelling purposes the segment forms part) were at constant speed V and power P_1 . The lateral attenuation of sound from the segment *received* by the observer, on the other hand, is related not to β_p , the elevation angle of the extended path, but to β , that of the equivalent level path.

The case of an observer ahead of the segment is not described separately; it is evident that this is essentially the same as the case of the observer behind.

However, for exposure level metrics where observer locations are behind ground segments during the takeoff roll and locations ahead of ground segments during the landing roll, the value of β becomes the same as that for maximum level metrics, i.e. $\beta = \beta_1 = \sin^{-1}(z_1/d_1)$ and $\ell = OC_1 = \sqrt{d_1^2 - z_1^2}$

The finite segment correction Δ_F (Exposure levels L_E only)

The adjusted baseline noise exposure level relates to an aircraft in continuous, straight, steady level flight (albeit with a bank angle ε that is inconsistent with straight flight). Applying the (negative) *finite segment correction* $\Delta_F = 10 \cdot \lg(F)$, where F is the *energy fraction*, further adjusts the level to what it would be if the aircraft traversed the finite segment only (or were completely silent for the remainder of the infinite flight path).

The energy fraction term accounts for the pronounced longitudinal directivity of aircraft noise and the angle subtended by the segment at the observer position. Although the processes that cause the directionality are very complex, studies have shown that the resulting contours are quite insensitive to the precise directional characteristics assumed. The expression for Δ_F below is based on a fourth-power 90-degree dipole model of sound radiation. It is assumed to be unaffected by lateral directivity and attenuation. How this correction is derived is described in detail in **Appendix E**.

The energy fraction F is a function of the 'view' triangle $\mathbf{OS}_1\mathbf{S}_2$ defined in **Figures 2.7.j to 2.7.l** such that:

$$\Delta_F = 10 \cdot \lg \left[\frac{1}{\pi} \left(\frac{\alpha_2}{1 + \alpha_2^2} + \arctan \alpha_2 - \frac{\alpha_1}{1 + \alpha_1^2} - \arctan \alpha_1 \right) \right] \quad (2.7.45)$$

with

$$\alpha_1 = -\frac{q}{d_\lambda}; \quad \alpha_2 = -\frac{q - \lambda}{d_\lambda}; \quad d_\lambda = d_0 \cdot 10^{[L_{Eso}(P, d_p) - L_{max}(P, d_p)]/10}; \quad d_0 = \frac{2}{\pi} \cdot V_{ref} \cdot t_0.$$

where d_λ is known as the 'scaled distance' (see **Appendix E**). Note that $L_{max}(P, d_p)$ is the maximum level, from NPD data, for perpendicular distance d_p , NOT the segment L_{max} .

It is advised to apply a lower limit of -150 dB to Δ_F .

In the particular case of observer locations behind every takeoff ground-roll segment and every landing ground-roll segment, a reduced form of the noise fraction expressed in equation (2.7.45) is used, which corresponds to the specific case of $q = 0$. This is computed using

$$\Delta_{F'} = 10 \log_{10} \left[(1/\pi) [\alpha_2/(1 + \alpha_2^2) + \tan^{-1} \alpha_2] 10^{\Delta_{SOR}/10} \right] \quad (2.7.46)$$

where $\alpha_2 = \lambda/d_\lambda$ and Δ_{SOR} is the start-of-roll directivity function defined by equations (2.7.51) and (2.7.52).

The rationale for using this particular form of noise fraction is further explained in the section below, as part of the start-of-roll directivity application method.

Specific Treatments of Ground-roll Segments, including the start-of-roll directivity function Δ_{SOR}

In the case of ground roll segments, both for takeoff and landing, specific treatments are applied, which are described below.

The start-of-roll directivity function Δ_{SOR}

The noise of jet aircraft — especially those equipped with lower by-pass ratio engines — exhibits a lobed radiation pattern in the rearward arc, which is characteristic of jet exhaust noise. This pattern is the more pronounced the higher the jet velocity and the lower the aircraft speed. This is of special significance for observer locations behind the start of roll, where both conditions are fulfilled. This effect is taken into account by a directivity function Δ_{SOR} .

The function Δ_{SOR} has been derived from several noise measurement campaigns using microphones adequately positioned behind and on the side of the SOR of departing jet aircraft.

Figure 2.7.r shows the relevant geometry. The azimuth angle ψ between the aircraft longitudinal axis and the vector to the observer is defined by

$$\psi = \arccos\left(\frac{q}{d_{SOR}}\right). \tag{2.7.47}$$

The relative distance q is negative (see **Figure 2.7.j**) so that ψ ranges from 0° in the direction of the aircraft forward heading to 180° in the reverse direction.

Figure 2.7.r

Aircraft-observer geometry at ground for estimation of directivity correction

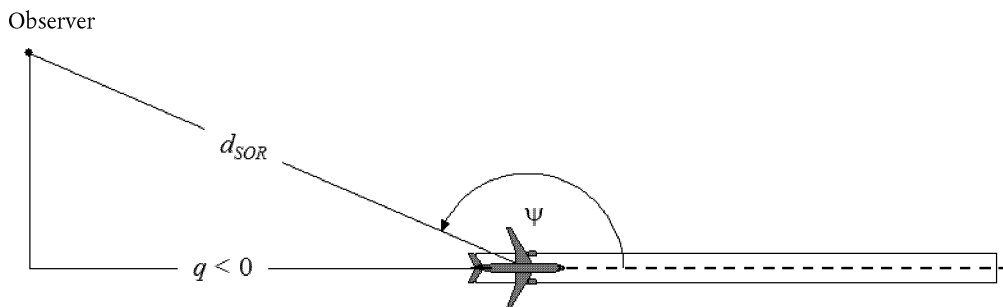

The function Δ_{SOR} represents the variation of the overall noise emanating from the takeoff ground roll measured behind the start of roll, relatively to the overall noise from takeoff ground roll measured on the side of the SOR, at the same distance:

$$L_{TGR}(d_{SOR}, \psi) = L_{TGR}(d_{SOR}, 90^\circ) + \Delta_{SOR}(d_{SOR}, \psi) \tag{2.7.48}$$

where $L_{TGR}(d_{SOR}, 90^\circ)$ is the overall takeoff ground roll noise level generated by all takeoff ground roll segments at the point distance d_{SOR} to the side of the SOR. At distances d_{SOR} less than a normalising distance $d_{SOR,0}$, the SOR directivity function is given by

$$\Delta_{SOR}^0 = 51,47 - 1,553 \cdot \psi + 0,015147 \cdot \psi^2 - 0,000047173 \cdot \psi^3 \quad \text{if } 90^\circ \leq \psi < 148,4^\circ \quad (2.7.49)$$

$$\Delta_{SOR}^0 = 339,18 - 2,5802 \cdot \psi - 0,0045545 \cdot \psi^2 + 0,000044193 \cdot \psi^3 \quad \text{if } 148,4^\circ \leq \psi \leq 180^\circ \quad (2.7.50)$$

If the distance d_{SOR} exceeds the normalising distance $d_{SOR,0}$, the directivity correction is multiplied by a correction factor to account for the fact that the directivity becomes less pronounced for greater distances from the aircraft; i.e.

$$\Delta_{SOR} = \Delta_{SOR}^0 \quad \text{if } d_{SOR} \leq d_{SOR,0} \quad (2.7.51)$$

$$\Delta_{SOR} = \Delta_{SOR}^0 \cdot \frac{d_{SOR,0}}{d_{SOR}} \quad \text{if } d_{SOR} > d_{SOR,0} \quad (2.7.52)$$

The normalising distance $d_{SOR,0}$ equals 762 m (2 500 ft).

Treatment of receivers located behind each takeoff and landing ground-roll segment

The Δ_{SOR} function described above mostly captures the pronounced directivity effect of the initial portion of the takeoff roll at locations behind the SOR (because it is the closest to the receivers, with the highest jet velocity to aircraft speed ratio). However, the use of the hence established Δ_{SOR} is 'generalised' to positions behind each individual ground roll segment — both takeoff and landing —, so not only behind the Start-of-Roll point (in the case of takeoff).

The parameters d_s and ψ are calculated relative to the start of each individual ground roll segment.

The event level L_{seg} for a location behind a given takeoff or landing ground-roll segment is calculated to comply with the formalism of the Δ_{SOR} function: it is essentially calculated for the reference point located on the side of the start point of the segment, at the same distance d_s as the actual point, and is further adjusted with Δ_{SOR} to obtain the event level at the actual point.

This means that the different correction terms in the equations below shall use the geometric parameters corresponding to this reference point located on the side of the start point:

$$L_{max,seg} = L_{max}(P, d = d_s) + \Delta_l(\varphi) - \Lambda(\beta, l = d_s) + \Delta_{SOR} \quad (2.7.53)$$

$$L_{E,seg} = L_{E,\infty}(P, d = d_s) + \Delta_V + \Delta_l(\varphi) - \Lambda(\beta, l = d_s) + \Delta'_F + \Delta_{SOR} \quad (2.7.54)$$

where Δ'_F is the reduced form of the noise fraction expressed in equation (2.7.46) for the case of $q = 0$ (as the reference point is located on the side of the start point) and remembering that d_λ shall be calculated using d_s (and not d_p):

$$d_\lambda = d_0 \cdot 10^{[L_{E,\infty}(P, d_s) - L_{max}(P, d_s)]/10} \quad (2.7.55)$$

2.7.20. Event noise level L of a general-aviation aircraft movement

The method described in Section 2.7.19 is applicable to propeller-engined general-aviation aircraft when they are treated as propeller aircraft with regard to engine installation effects.

The ANP database includes entries for several general aviation aircraft. Whilst these are often the most common general-aviation aircraft operating, there may be occasions when it is appropriate to use additional data.

Where the specific general aviation aircraft are either not known or not in the ANP database, it is recommended to use the more generic aircraft data, GASEPF and GASEPV respectively. These data sets represent a small single-engined general aviation aircraft with fixed-pitch and variable-pitch propellers respectively. Tables of entries are presented in Annex I (Tables I-11 I-17)

2.7.21. Method for the Calculation of Helicopter Noise

For the calculation of helicopter noise, the same calculation method used for fixed-wing aircraft (outlined in Section 2.7.14) may be used, provided helicopters are treated as propeller aircraft and engine-installation effects, associated with jet aircraft are not applied. Tables of entries for two different data sets are presented in Annex I (Tables I-18 I-27).

2.7.22. Noise associated with Engine Testing (Run-Up) Operations, taxiing and auxiliary power units

In such cases where it is considered that noise associated with engine testing and auxiliary power-units are to be modelled, these are modelled according to the chapter on industrial noise. Although it is normally not the case, noise from aircraft engine tests (sometimes referred to as 'engine run-ups') at airports can make a contribution to noise impacts. Usually carried out for engineering purposes to check engine performance, aircraft are safely positioned away from buildings, aircraft, vehicular and/or personnel movements to avoid any jet-blast related damage.

For additional safety and noise control reasons, airports, particularly those with maintenance facilities that can lead to frequent engine tests, can install so-called 'noise pens', 3-sided baffled enclosures specially designed to deflect and dissipate jet blast and noise. Investigating the noise impact of such facilities, which can be further attenuated and reduced by the use of additional earth bunds or substantial noise barrier fencing, is best accomplished by treating the noise pen as a source of industrial noise and using an appropriate noise and sound propagation model.

2.7.23. Calculation of cumulative levels

Sections 2.7.14 to 2.7.19 describe the calculation of the event sound noise level of a single aircraft movement at a single observer location. The total noise exposure at that location is calculated by accumulating the event levels of all noise-significant aircraft movements, i.e. all movements, inbound or outbound, that influence the cumulative level.

2.7.24. Weighted equivalent sound levels

Time-weighted equivalent sound levels, which account for all significant aircraft sound energy received, shall be expressed in a generic manner by the formula

$$L_{eq,W} = 10 \cdot \lg \left[\frac{t_0}{T_0} \cdot \sum_{i=1}^N g_i \cdot 10^{L_{E,i}/10} \right] + C \quad (2.7.56)$$

The summation is performed over all N noise events during the time interval T_0 to which the noise index applies. $L_{E,i}$ is the single event noise exposure level of the i -th noise event. g_i is a time-of-day dependent weighting factor (usually defined for day, evening and night periods). Effectively g_i is a multiplier for the number of flights occurring during the specific periods. The constant C can have different meanings (normalising constant, seasonal adjustment etc.).

Using the relationship

$$g_i = 10^{\Delta_i/10}$$

where Δ_i is the decibel weighting for the i -th period, equation (2.7.56) can be rewritten as

$$L_{eq,W} = 10 \cdot \lg \left[\frac{t_0}{T_0} \sum_{i=1}^N 10^{(L_{E,i} + \Delta_i)/10} \right] + C \quad (2.7.57)$$

i.e. the time-of-day weighting is expressed by an additive level offset.

2.7.25. The weighted number of operations

The cumulative noise level is estimated by summing the contributions from all different types or categories of aircraft using the different flight routes which comprise the airport scenario.

To describe this summation process the following subscripts are introduced:

- i index for aircraft type or category
- j index for flight track or subtrack (if subtracks are defined)
- k index for flight track segment

Many noise indices — especially equivalent sound levels — include time-of-day weighting factors g_i in their definition (equations (2.7.56) and (2.7.57)).

The summation process can be simplified by introducing a ‘weighted number of operations’

$$M_{ij} = (g_{day} \cdot N_{ij,day} + g_{evening} \cdot N_{ij,evening} + g_{night} \cdot N_{ij,night}) \quad (2.7.58)$$

The values N_{ij} represent the numbers of operations of aircraft type/category i on track (or subtrack) j during the day, evening and night period respectively ⁽¹⁾.

From equation (2.7.57) the (generic) cumulative equivalent sound level L_{eq} at the observation point (x,y) is

$$L_{eq,W}(x,y) = 10 \cdot \lg \left[\frac{t_0}{T_0} \cdot \sum_i \sum_j \sum_k M_{ij} \cdot 10^{L_{E,ijk}(x,y)/10} \right] + C \quad (2.7.59)$$

T_0 is the reference time period. It depends on — as well as the weighting factors g_i — the specific definition of the weighted index used (e.g. L_{DEN}). $L_{E,ijk}$ is the single event noise level contribution from segment k of track or subtrack j for an operation of aircraft of category i . The estimation of $L_{E,ijk}$ is described in detail in Sections 2.7.14 to 2.7.19.

⁽¹⁾ The time periods may differ from these three, depending on the definition of the noise index used.

2.7.26. Standard grid calculation and refinement

When noise contours are obtained by interpolation between index values at rectangularly spaced grid points, their accuracy depends on the choice of the grid spacing (or mesh size) Δ_G , especially within cells where large gradients in the spatial distribution of the index cause tight curvature of the contours (see **Figure 2.7.s**). Interpolation errors are reduced by narrowing the grid spacing, but as this increases the number of grid points, the computation time is increased. Optimising a regular grid mesh involves balancing modelling accuracy and run time.

Figure 2.7.s

Standard grid and grid refinement

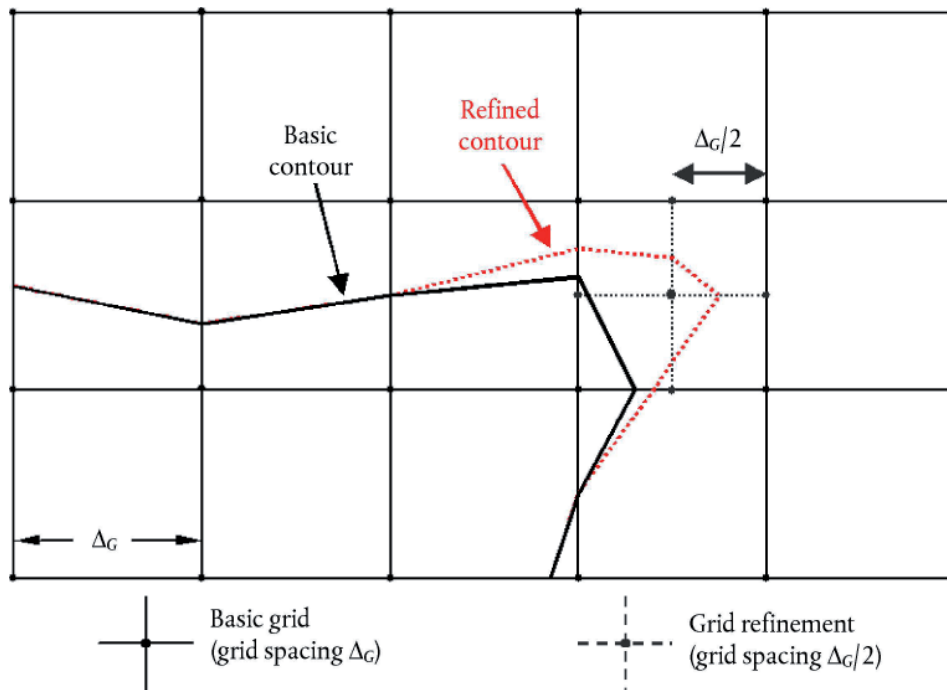

A marked improvement in computing efficiency that delivers more accurate results is to use an irregular grid to refine the interpolation in critical cells. The technique, depicted in **Figure 2.7.s**, is to tighten the mesh locally, leaving the bulk of the grid unchanged. This is very straightforward and achieved by the following steps:

- (1) Define a refinement threshold difference ΔL_R for the noise index.
- (2) Calculate the basic grid for a spacing Δ_G .
- (3) Check the differences ΔL of the index values between adjacent grid nodes.
- (4) If there are any differences $\Delta L > \Delta L_R$, define a new grid with a spacing $\Delta_G/2$ and estimate the levels for the new nodes in the following way:

$$\text{If } \begin{cases} \Delta L \leq \Delta L_R \\ \Delta L > \Delta L_R \end{cases} \quad \text{calculate the new value } \begin{cases} \text{by linear interpolation from the adjacent ones.} \\ \text{completely anew from the basic input data.} \end{cases}$$

- (5) Repeat steps 1-4 until all differences are less than the threshold difference.
- (6) Estimate the contours by linear interpolation.

If the array of index values is to be aggregated with others (e.g. when calculating weighted indices by summing separate day, evening and night contours) care is required to ensure that the separate grids are identical.

2.7.27. Use of rotated grids

In many practical cases, the true shape of a noise contour tends to be symmetrical about a ground track. However if the direction of this track is not aligned with the calculation grid, this can cause result in an asymmetric contour shape.

Figure 2.7.t

Use of a rotated grid

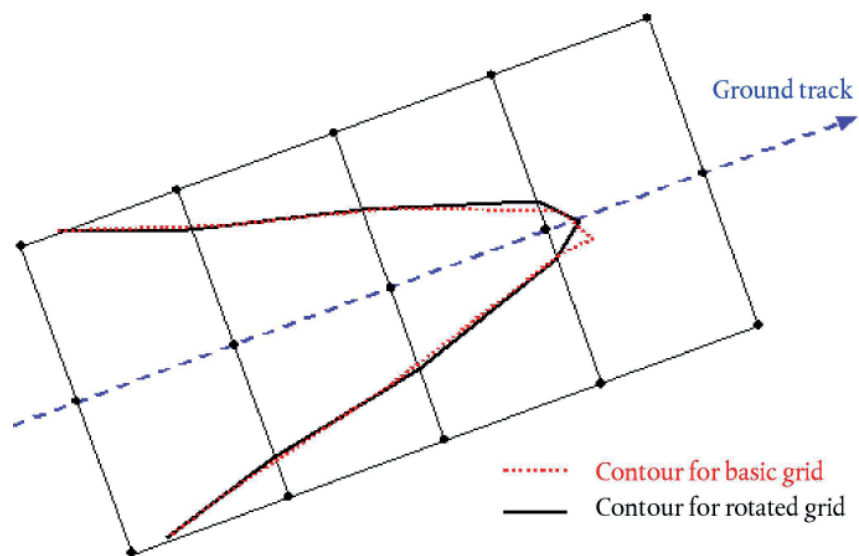

The straightforward way to avoid this effect is to tighten the grid. However this increases computation time. A more elegant solution is to rotate the computation grid so that its direction is parallel to the main ground tracks (i.e. usually parallel to the main runway). **Figure 2.7.t** shows the effect of such a grid rotation on the contour shape.

2.7.28. Tracing of contours

A very time-efficient algorithm that eliminates the need to calculate a complete grid array of index values at the expense of a little more computational complexity is to trace the path of the contour, point by point. This option requires two basic steps to be performed and repeated (see **Figure 2.7.u**):

Figure 2.7.u

Concept of tracing algorithm

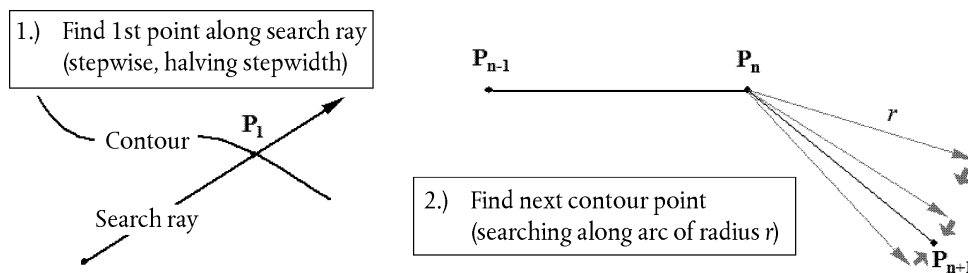

Step 1 is to find a first point P_1 on the contour. This is done by calculating the noise index levels L in equidistant steps along a 'search ray' that is expected to cross the required contour of level L_c . When the contour is crossed, the difference $\delta = L_c - L$ changes sign. If this happens, the step-width along the ray is halved and the search direction is reversed. This is done until δ is smaller than a pre-defined accuracy threshold.

Step 2, which is repeated until the contour is sufficiently well defined, is to find the next point on the contour L_c — which is at a specified straight line distance r from the current point. During consecutive angular steps, index levels and differences δ are calculated at the ends of vectors describing an arc with radius r . By similarly halving and reversing the increments, this time in the directions of the vector, the next contour point is determined within a predefined accuracy.

Figure 2.7.v

Geometric parameters defining conditions for the tracing algorithm

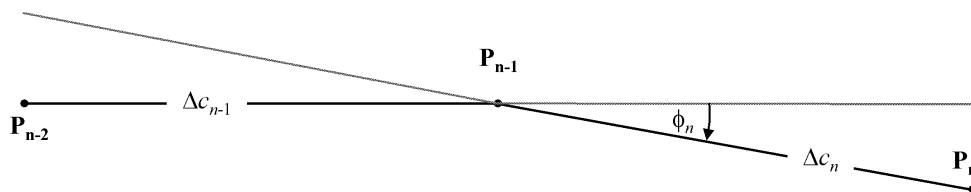

Some constraints shall be imposed to guarantee that the contour is estimated with a sufficient degree of accuracy (see **Figure 2.7.v**):

- (1) The length of the chord Δc (the distance between two contour points) shall be within an interval $[\Delta c_{min}, \Delta c_{max}]$, e.g. [10 m, 200 m].
- (2) The length ratio between two adjacent chords of lengths Δc_n and Δc_{n+1} shall be limited, e.g. $0,5 < \Delta c_n / \Delta c_{n+1} < 2$.

- (3) With respect to a good fit of the chord length to the contour curvature the following condition shall be fulfilled:

$$\Phi_n \cdot \max(\Delta c_{n-1}, \Delta c_n) \leq \varepsilon \quad (\varepsilon \approx 15 \text{ m})$$

where Φ_n is the difference in the chord headings.

Experience with this algorithm has shown that, on an average, between 2 and 3 index values have to be calculated to determine a contour point with an accuracy of better than 0,01 dB.

Especially when large contours have to be calculated this algorithm speeds up computation time dramatically. However it should be noted that its implementation requires experience, especially when a contour breaks down into separate islands.

2.8. Assigning noise levels and population to buildings

For the assessment of the noise exposure of the population only residential buildings shall be considered. No people shall be assigned to other buildings without residential use such as schools, hospitals, office buildings or factories. The assignment of the population to the residential buildings shall be based on the latest official data (depending on the Member State's relevant regulations).

Because aircraft calculation are performed on a 100 m × 100 m resolution grid, the specific case of aircraft noise, levels shall be interpolated based on the nearest grid noise levels.

Determination of the number of inhabitants of a building

The number of inhabitants of a residential building is an important intermediate parameter for the estimation of the exposure to noise. Unfortunately, data on this parameter is not always available. Below it is specified how this parameter can be derived from data more readily available.

Symbols used in the following are:

BA	= base area of the building
DFS	= dwelling floor space
DUFS	= dwelling unit floor space
H	= height of the building
FSI	= dwelling floor space per inhabitant
Inh	= number of inhabitants
NF	= number of floors
V	= volume of residential buildings

For the calculation of the number of inhabitants, either the following case 1 procedure or the case 2 procedure shall be used, depending on the availability of data.

CASE 1: the data on the number of inhabitants is available

1A: The number of inhabitants is known or has been estimated on the basis of dwelling units. In this case the number of inhabitants of a building is the sum of the number of inhabitants of all dwelling units in the building:

$$Inh_{\text{building}} = \sum_{i=1}^n Inh_{\text{dwellingunit}_i} \quad (2.8.1)$$

1B: The number of inhabitants is known only for entities larger than a building, e.g. sides of city blocks, city blocks, districts or even an entire municipality. In this case the number of inhabitants of a building is estimated based on the volume of the building:

$$Inh_{building} = \frac{V_{building}}{V_{total}} \times Inh_{total} \quad (2.8.2)$$

The index 'total' here refers to the respective entity considered. The volume of the building is the product of its base area and its height:

$$V_{building} = BA_{building} \times H_{building} \quad (2.8.3)$$

If the height of the building is not known, it shall be estimated based on the number of floors $NF_{building}$, assuming an average height per floor of 3 m:

$$H_{building} = NF_{building} \times 3 \text{ m} \quad (2.8.4)$$

If the number of floors is also not known, a default value for the number of floors representative of the district or the borough shall be used.

The total volume of residential buildings in the entity considered V_{total} is calculated as the sum of the volumes of all residential buildings in the entity:

$$V_{total} = \sum_{i=1}^n V_{building_i} \quad (2.8.5)$$

CASE 2: no data on the number of inhabitants is available

In this case the number of inhabitants is estimated based on the average dwelling floor space per inhabitant FSI . If this parameter is not known, a national default value shall be used.

2A: The dwelling floor space is known on the basis of dwelling units. In this case the number of inhabitants of each dwelling unit is estimated as follows:

$$Inh_{dwelling_{unit_i}} = \frac{DUFS_i}{FSI} \quad (2.8.6)$$

The number of inhabitants of the building can now be estimated as in CASE 1A above.

2B: The dwelling floor space is known for the entire building, i.e. the sum of the dwelling floor spaces of all dwelling units in the building is known. In this case the number of inhabitants is estimated as follows:

$$Inh_{building} = \frac{DFS_{building}}{FSI} \quad (2.8.7)$$

2C: The dwelling floor space is known only for entities larger than a building, e.g. sides of city blocks, city blocks, districts or even an entire municipality.

In this case the number of inhabitants of a building is estimated based on the volume of the building as described in CASE 1B above with the total number of inhabitants estimated as follows:

$$Inh_{total} = \frac{DFS_{total}}{FSI} \quad (2.8.8)$$

2D: The dwelling floor space is unknown. In this case the number of inhabitants of a building is estimated as described in CASE 2B above with the dwelling floor space estimated as follows:

$$DFS_{building} = BA_{building} \times 0,8 \times NF_{building} \quad (2.8.9)$$

The factor 0,8 is the conversion factor *gross floor area* → *dwelling floor space*. If a different factor is known to be representative of the area it shall be used instead and clearly documented.

If the number of floors of the building is not known, it shall be estimated based on the height of the building, $H_{building}$, typically resulting in a non-integer number of floors:

$$NF_{building} = \frac{H_{building}}{3 \text{ m}} \quad (2.8.10)$$

If neither the height of the building nor the number of floors is known, a default value for the number of floors representative of the district or the borough shall be used.

Assigning receiver points to the façades of buildings

The assessment of population exposure to noise is based on receiver point levels at 4 m above the terrain level in front of building façades of residential buildings.

For the calculation of the number of inhabitants, either the following case 1 procedure or the case 2 procedure shall be used for land based noise sources. For aircraft noise calculated according to 2.6, all population of a building is associated to the nearest noise calculation point on the grid.

CASE 1

Figure a

Example of location of receivers around a building following CASE 1 procedure

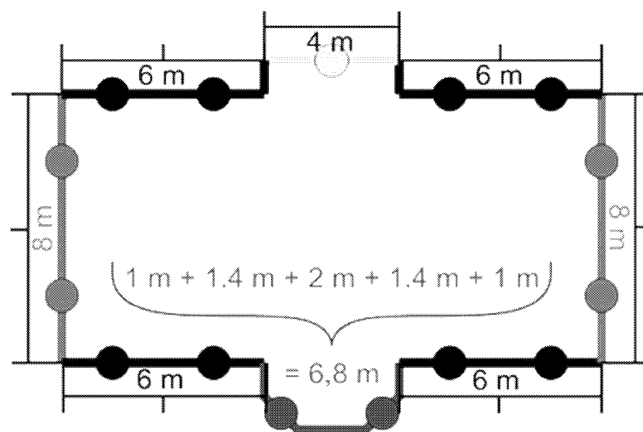

- (a) Segments of a length of more than 5 m are split up into regular intervals of the longest possible length, but less than or equal to 5 m. Receiver points are placed in the middle of each regular interval.
- (b) Remaining segments above a length of 2,5 m are represented by one receiver point in the middle of each segment.

- (c) Remaining adjacent segments with a total length of more than 5 m are treated as polyline objects in a manner similar to that described in (a) and (b).
- (d) The number of inhabitants allocated to a receiver point, shall be weighted by the length of the represented façade so that the sum over all receiver points represents the total number of inhabitants.
- (e) Only for buildings with floor sizes that indicate a single dwelling per floor level, the most exposed façade noise level is directly used for the statistics and related to the number of inhabitants.

CASE 2

Figure b

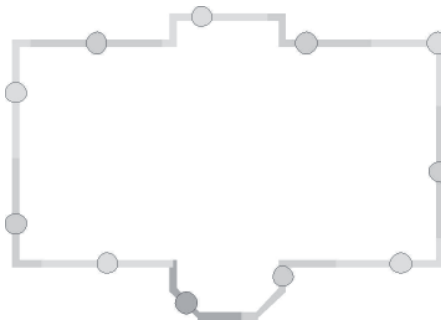
Example of location of receivers around a building following CASE 2 procedure

- (a) Façades are considered separately or are split up every 5 m from the start position onwards, with a receiver position placed at the half-way distance of the façade or the 5 m segment
- (b) The remaining section has its receiver point in its mid-point.
- (c) The number of inhabitants allocated to a receiver point, shall be weighted by the length of the represented façade so that the sum over all receiver points represents the total number of inhabitants.
- (d) Only for buildings with floor sizes that indicate a single dwelling per floor level, the most exposed façade noise level is directly used for the statistics and related to the number of inhabitants.

3. INPUT DATA

Input data to be used as appropriate in association with the methods described above are given in Appendix F to Appendix I.

In cases where input data provided in Appendix F to Appendix I are not applicable or cause deviations from the true value that do not meet the conditions presented under 2.1.2 and 2.6.2, other values can be used, provided that the values used and the methodology used to derive them are sufficiently documented, including demonstrating their suitability. This information shall be made publicly available.

4. MEASUREMENT METHODS

In cases when, for any reason, measurements are performed, these shall be in accordance with the principles governing long term average measurements stated in ISO 1996-1:2003 and ISO 1996-2:2007 or, for aircraft noise, ISO 20906:2009.

Appendix A

Data requirements

Section 2.7.6 of the main text describes in general terms the requirements for case-specific data describing an airport and its operations that are needed for noise contour calculations. The following datasheets are filled with example data for a hypothetical airport. Specific data formats will generally depend on the requirements and needs for the particular noise modelling system as well as the study scenario.

Note: It is recommended that geographic information (reference points etc.) be specified in Cartesian coordinates. The choice of the particular coordinate system usually depends on the maps available.

A1 GENERAL AIRPORT DATA

Aerodrome designation	Hypothetical Airport	
Coordinate system	UTM, Zone 15, Datum WGS-84	
Aerodrome reference point, ARP	3 600 000 m E	6 300 000 m N
	Mid-point of runway 09L-27R	
Altitude of ARP	120 m /	
Average air temperature at ARP (*)	12,0 °C	
Average relative humidity at ARP (*)	60 %	
Average wind speed & direction (*)	5 kt	270 degrees
Source of topographical data	Unknown	
(*) Repeat for each time interval of interest (time of day, season, etc.)		

A2 RUNWAY DESCRIPTION

Runway designation	09L	
Start of runway	3 599 000 m E	6 302 000 m N
End of runway	3 603 000 m E	6 302 000 m N
Start of roll	3 599 000 m E	6 302 000 m N
Landing threshold	3 599 700 m E	6 302 000 m N
Altitude of start of runway	110 m	
Mean runway gradient	0,001	

For displaced thresholds, runway description may be repeated or displaced thresholds can be described in the ground track description section.

A3 GROUND TRACK DESCRIPTION

In the absence of radar data the following information is needed to describe particular ground tracks.

Track No		001			
Track designation		Dep 01 — 09L			
From runway		09L			
Type of track		Departure			
Displacement from start of roll		0 m			
Number of subtracks:		7			
Backbone track description					
Segment No	Straight [m]	Curve			Standard deviation for lateral dispersion at segment end [m]
		L/R	Heading change [°]	Radius [m]	
1	10 000				2 000
3		R	90,00	3 000	2 500
4	20 000				3 000

Track No		002			
Track designation		App 01 — 09L — Disp 300			
From runway		09L			
Type of track		Approach			
Displacement from landing threshold		300 m			
Number of subtracks:		1			
Backbone track description					
Segment No	Straight [m]	Curve			Standard deviation for lateral dispersion at segment end [m]
		L/R	Heading change [°]	Radius [m]	
1	30 000				0
Approach track information					
Glide angle for approach tracks		2,7°			
Flight altitude at glide slope interception		4 000 ft			

A4 AIR TRAFFIC DESCRIPTION

Reference time period	366 d (01-01-2014 to 31-12-2014)	= 8 784 h
Time of day period I	From 7 to 19 h	= 12 h
Time of day period II	From 19 to 23 h	= 4 h
Time of day period III	From 23 to 7 h	= 8 h

AIR TRAFFIC DESCRIPTION DATA SHEET — MOVEMENTS PER TRACK			
Ground track No		001	
Track designation		Dep 01 — 09L	
Aircraft designation	Movements during time period		
	I	II	III
A/C 1, Dep.1	20 000	4 000	1 000
A/C 2, Dep.4	10 000	5 000	500
A/C 4, Dep.3	2 000	300	0
Ground track No		002	
Track designation		Dep 01 — 09L — Disp 300	
Aircraft designation	Movements during time period		
	I	II	III
A/C 1, App.1	18 000	2 000	5 000
A/C 2, App.1	10 000	3 000	2 500
A/C 4, App.1	1 300	0	1 000

A5 FLIGHT PROCEDURE DATA SHEET

Example aircraft for a Chapter 3 Boeing 727-200 as derived from radar using the guidance set out in Section 2.7.9 of the main text.

Aircraft designation		B727C3		
NPD-Identifier from ANP database		JT8E5		
No of engines		3		
Mode of operation		Departure		
Actual aircraft mass [t]		71,5		
Headwind [m/s]		5		
Temperature [°C]		20		
Airport elevation [m]		83		
Segment No	Dist. from RP ⁽¹⁾ [m]	Height [m]	Ground speed [m/s]	Engine Power ⁽²⁾
1	0	0	0	14 568
2	2 500	0	83	13 335
3	3 000	117	88	13 120
4	4 000	279	90	13 134
5	4 500	356	90	13 147
6	5 000	431	90	13 076
7	6 000	543	90	13 021
8	7 000	632	93	12 454
9	8 000	715	95	10 837
10	10 000	866	97	10 405
11	12 000	990	102	10 460
12	14 000	1 122	111	10 485
13	16 000	1 272	119	10 637
14	18 000	1 425	125	10 877
15	20 000	1 581	130	10 870
16	25 000	1 946	134	10 842
17	30 000	2 242	142	10 763
⁽¹⁾ The reference point RP is the start of roll for departures and the landing threshold for approaches. ⁽²⁾ Units corresponding to units in ANP database.				

Example for a procedural profile based on A/C-data stored in ANP database:

Aircraft designation from ANP database		B727C3		
NPD-Identifier from ANP database		JT8E5		
No of engines		3		
Mode of operation		Departure		
Actual aircraft mass [t]		71,5		
Headwind [m/s]		5		
Temperature [°C]		15		
Airport elevation [m]		100		
Segment No	Mode	Target	Flaps	Engine Power
1	Takeoff		5	Takeoff
2	Initial Climb	Altitude 1 500 ft	5	Takeoff
3	Retract Flaps	210 kts IAS ROC 750 ft/min	0	Max. Climb
4	Accelerate	250 kts IAS ROC 1 500 ft/min	0	Max. Climb
5	Climb	10 000 ft	0	Max. Climb

Appendix B

Flight performance calculations

Terms and symbols

The terms and symbols used in this appendix are consistent with those conventionally used by aircraft performance engineers. Some basic terms are explained briefly below for the benefit of users not familiar with them. To minimise conflict with the main body of the method, symbols are mostly defined separately within this appendix. Quantities that are referenced in the main body of the method are assigned common symbols; a few that are used differently in this appendix are marked with an asterisk (*). There is some juxtaposition of US and SI units; again this is to preserve conventions that are familiar to users from different disciplines.

Terms

Break point	See Flat Rating
Calibrated airspeed	(Otherwise termed equivalent or indicated airspeed.) The speed of the aircraft relative to the air as indicated by a calibrated instrument on the aircraft. The true airspeed, which is normally greater, can be calculated from the calibrated airspeed knowing the air density.
Corrected net thrust	Net thrust is the propulsive force exerted by an engine on the airframe. At a given power setting (<i>EPR</i> or N_1) this falls with air density as altitude increases; corrected net thrust is the thrust at sea level.
Flat rating	For specific maximum component temperatures, the engine thrust falls as the ambient air temperature rises — and <i>vice-versa</i> . This means that there is a critical air temperature above which the <i>rated thrust</i> cannot be achieved. For most modern engines this is called the 'flat rated temperature' because, at lower air temperatures the thrust is automatically limited to the rated thrust to maximise service life. The thrust falls anyway at temperatures above the flat rated temperature — which is often called the <i>break point</i> or <i>break temperature</i> .
Speed	Magnitude of aircraft velocity vector (relative to aerodrome coordinate system)
Rated thrust	The service life of an aircraft engine is very dependent upon the operating temperatures of its components. The greater the power or trust generated, the higher the temperatures and the shorter the life. To balance performance and life requirements flat rated engines are assigned <i>thrust ratings</i> for take-off, climb and cruise which define normal maximum power settings.
Thrust setting parameter	The pilot cannot select a particular engine thrust; rather s/he chooses an appropriate setting of this parameter which is displayed in the cockpit. It is usually either the engine pressure ratio (<i>EPR</i>) or low- pressure rotor (or fan) rotational speed (N_1).

Symbols

Quantities are dimensionless unless otherwise stated. Symbols and abbreviations not listed below are used only locally and defined in the text. Subscripts 1 and 2 denote conditions at the start and end of a segment respectively. Overbars denote segment mean values, i.e. average of start and end values.

a	Average acceleration, ft/s ²
a_{max}	Maximum acceleration available, ft/s ²
A, B, C, D	Flap coefficients
$E, F, G_{A,B}, H$	Engine thrust coefficients
F_n	Net thrust per engine, lbf

F_n/δ	Corrected net thrust per engine, lbf
G	Climb gradient
G'	Engine-out climb gradient
G_R	Mean runway gradient, positive uphill
g	Gravitational acceleration, ft/s ²
ISA	International Standard Atmosphere
N^*	No of engines supplying thrust
R	Drag-to-lift ratio C_D/C_L
ROC	Segment rate of climb (ft/min)
s	Ground distance covered along ground track, ft
s_{TO8}	Take-off distance into an 8 kt headwind, ft
s_{TOG}	Take-off distance corrected for w and G_R , ft
s_{TOw}	Take-off distance into headwind w , ft
T	Air temperature, °C
T_b	Breakpoint temperature, °C
V	Groundspeed, kt
V_c	Calibrated airspeed, kt
V_T	True airspeed, kt
W	Aeroplane weight, lb
w	Headwind speed, kt
Δs	Still air segment length projected onto ground track, ft
Δs_w	Segment length ground projection corrected for headwind, ft
δ	p/p_o , the ratio of the ambient air pressure at the aeroplane to the standard air pressure at mean sea level: $p_o = 101,325$ kPa (or 1 013,25 mb)
ϵ	Bank angle, radians
γ	Climb/descent angle, radians
ϑ	$(T + 273,15)/(T_o + 273,15)$ the ratio of the air temperature at altitude to the standard air temperature at mean sea level: $T_o = 15,0$ °C
σ^*	$\rho/\rho_o =$ Ratio of air density at altitude to mean sea level value (also, $\sigma = \delta/\vartheta$)

B1 INTRODUCTION

Flight path synthesis

In the main, this appendix recommends procedures for calculating an aeroplane flight profile, based on specified aerodynamic and powerplant parameters, aircraft weight, atmospheric conditions, ground track and operating procedure (flight configuration, power setting, forward speed, vertical speed, etc.). The operating procedure is described by a set of *procedural steps* that prescribe how to fly the profile.

The flight profile, for takeoff or approach, is represented by a series of straight-line segments, the ends of which are termed *profile points*. It is calculated using aerodynamic and thrust equations containing numerous coefficients and constants which must be available for the specific combination of airframe and engine. This calculation process is described in the text as the process of flight path *synthesis*.

Apart from the aircraft performance parameters, which can be obtained from the ANP database, these equations require specification of (1) aeroplane gross weight, (2) the number of engines, (3) air temperature, (4) runway elevation, and (5) the procedural steps (expressed in terms of power settings, flap deflections, airspeed and, during acceleration, average rate-of-climb/descent) for each segment during takeoff and approach. Each segment is then classified as a ground roll, take-off or landing, constant speed climb, power cutback, accelerating climb with or without flap retraction, descent with or without deceleration and/or flap deployment, or final landing approach. The flight profile is built up step by step, the starting parameters for each segment being equal to those at the end of the preceding segment.

The aerodynamic-performance parameters in the ANP database are intended to yield a reasonably accurate representation of an aeroplane's actual flight path for the specified reference conditions (see **Section 2.7.6 of the main text**). But the aerodynamic parameters and engine coefficients have been shown to be adequate for air temperatures up to 43 °C, aerodrome altitudes up to 4 000 ft and across the range of weights specified in the ANP database. The equations thus permit the calculation of flight paths for other conditions; i.e. non-reference aeroplane weight, wind speed, air temperature, and runway elevation (air pressure), normally with sufficient accuracy for computing contours of average sound levels around an airport.

Section B-4 explains how the effects of turning flight are taken into account for departures. This allows bank angle to be accounted for when calculating the effects of lateral directivity (installation effects). Also, during turning flight, climb gradients will generally be reduced depending in the radius of the turn and the speed of the aeroplane. (The effects of turns during the landing approach are more complex and are not covered at present. However these will rarely influence noise contours significantly.)

Sections B-5 to B-9 describe the recommended methodology for generating departure flight profiles, based on ANP database coefficients and procedural steps.

Sections B-10 and B-11 describe the methodology used to generate approach flight profiles, based on ANP database coefficients and flight procedures.

Section B-12 provides worked examples of the calculations.

Separate sets of equations are provided to determine the net thrust produced by jet engines and propellers respectively. Unless noted otherwise, the equations for aerodynamic performance of an aeroplane apply equally to jet and propeller-powered aeroplanes.

Mathematical symbols used are defined at the beginning of this appendix and/or where they are first introduced. In all equations the units of coefficients and constants must of course be consistent with the units of the corresponding parameters and variables. For consistency with the ANP database, the conventions of aircraft performance engineering are followed in this appendix; distances and heights in feet (ft), speed in knots (kt), mass in pounds (lb), force in pounds-force (high-temperature corrected net thrust), and so on — even though some dimensions (e.g. atmospheric ones) are expressed in SI units. Modellers using other unit systems should be very careful to apply appropriate conversion factors when adopting the equations to their needs.

Flight path analysis

In some modelling applications the flight path information is provided not as procedural steps but as coordinates in position and time, usually determined by analysis of radar data. This is discussed in **Section 2.7.7** of the main text. In this case the equations presented in this Appendix are used 'in reverse'; the engine thrust parameters are derived from the aircraft motion rather than vice-versa. In general, once the flight path data has been averaged and reduced to segment form, each segment being classified by climb or descent, acceleration or deceleration, and thrust and flap changes, this is relatively straightforward by comparison with synthesis which often involves iterative processes.

B2 ENGINE THRUST

The propulsive force produced by each engine is one of five quantities that need to be defined at the ends of each flight path segment (the others being height, speed, power setting and bank angle). Net thrust represents the component of engine gross thrust that is available for propulsion. For aerodynamic and acoustical calculations, the net thrust is referred to standard air pressure at mean sea level. This is known as *corrected net thrust*, F_n/δ .

This will be either the net thrust available when operating at a specified *thrust rating*, or the net thrust that results when the *thrust-setting parameter* is set to a particular value. For a turbojet or turbofan engine operating at a specific thrust rating, corrected net thrust is given by the equation

$$F_n/\delta = E + F \cdot V_c + G_A \cdot h + G_B \cdot h^2 + H \cdot T \quad (\text{B-1})$$

where

- F_n is the net thrust per engine, lbf
- δ is the ratio of the ambient air pressure at the aeroplane to the standard air pressure at mean sea level, i.e., to 101,325 kPa (or 1 013,25 mb) [ref. 1]
- F_n/δ is the corrected net thrust per engine, lbf
- V_c is the calibrated airspeed, kt
- T is the ambient air temperature in which the aeroplane is operating, °C, and
- E, F, G_A, G_B, H are engine thrust constants or coefficients for temperatures below the engine flat rating temperature at the thrust rating in use (on the current segment of the takeoff/climbout or approach flight path), lb.s/ft, lb/ft, lb/ft², lb/°C. Obtainable from the ANP database.

Data are also provided in the ANP database to allow calculation of non-rated thrust as a function of a thrust setting parameter. This is defined by some manufacturers as engine pressure ratio *EPR*, and by others as low-pressure rotor speed, or fan speed, N_1 . When that parameter is *EPR*, equation B-1 is replaced by

$$F_n/\delta = E + F \cdot V_c + G_A \cdot h + G_B \cdot h^2 + H \cdot T + K_1 \cdot EPR + K_2 \cdot EPR^2 \quad (\text{B-2})$$

where K_1 and K_2 are coefficients, from the ANP database that relate corrected net thrust and engine pressure ratio in the vicinity of the engine pressure ratio of interest for the specified aeroplane Mach number.

When engine rotational speed N_1 is the parameter used by the cockpit crew to set thrust, the generalised thrust equation becomes

$$F_n/\delta = E + F \cdot V_c + G_A \cdot h + G_B \cdot h^2 + H \cdot T + K_3 \cdot \left(\frac{N_1}{\sqrt{\vartheta}}\right) + K_4 \cdot \left(\frac{N_1}{\sqrt{\vartheta}}\right)^2 \quad (\text{B-3})$$

where

- N_1 is the rotational speed of the engine's low-pressure compressor (or fan) and turbine stages, %
- $\vartheta = (T + 273)/288,15$, the ratio of the absolute total temperature at the engine inlet to the absolute standard air temperature at mean sea level [ref. 1].
- $\frac{N_1}{\sqrt{\vartheta}}$ is the corrected low pressure rotor speed, %; and
- K_3, K_4 are constants derived from installed engine data encompassing the N_1 speeds of interest.

Note that for a particular aeroplane E , F , G_A , G_B and H in equations B-2 and B-3 might have different values from those in equation B-1.

Not every term in the equation will always be significant. For example, for flat-rated engines operating in air temperatures below the break point (typically 30 °C), the temperature term may not be required. For engines not flat rated, ambient temperature must be considered when designating rated thrust. Above the engine flat rating temperature, a different set of engine thrust coefficients (E , F , G_A , G_B and H)_{high} must be used to determine the thrust level available. Normal practice would then be to compute F_n/δ using both the low temperature and high temperature coefficients and to use the higher thrust level for temperatures *below* the flat rating temperature and use the lower calculated thrust level for temperature *above* the flat rating temperature.

Where only low temperature thrust coefficients are available, the following relationship may be used:

$$(F_n/\delta)_{high} = F \cdot V_c + (E + H \cdot T_B) \cdot (1 - 0,006 \cdot T) / (1 - 0,006 \cdot T_B) \quad (B-4)$$

where

$(F_n/\delta)_{high}$ high-temperature corrected net thrust (lbf),

T_B breakpoint temperature (in the absence of a definitive value assume a default value of 30 °C).

The ANP database provides values for the constants and coefficients in equations B-1 to B-4.

For propeller driven aeroplanes, corrected net thrust per engine should be read from graphs or calculated using the equation

$$F_n/\delta = (326 \cdot \eta \cdot P_p/V_T)/\delta \quad (B-5)$$

where

η is the propeller efficiency for a particular propeller installation and is a function of propeller rotational speed and aeroplane flight speed

V_T is the true airspeed, kt

P_p is net propulsive power for the given flight condition, e.g. max takeoff or max climb power, hp

Parameters in equation B-5 are provided in the ANP database for maximum takeoff thrust and maximum climb thrust settings.

True airspeed V_T is estimated from the calibrated airspeed V_c using the relationship

$$V_T = V_c/\sqrt{\sigma} \quad (B-6)$$

where σ is the ratio of the air density at the aeroplane to the mean sea-level value.

Guidance on operation with reduced takeoff thrust

Often, aircraft takeoff weights are below maximum allowable and/or the available runway field length exceeds the minimum required with the use of maximum takeoff thrust. In these cases, it is common practice to reduce engine thrust below maximum levels in order to prolong engine life and, sometimes, for noise abatement purposes. Engine thrust can only be reduced to levels that maintain a required margin of safety. The calculation procedure used by airline operators to determine the amount of thrust reduction is regulated accordingly: it is complex and takes into account numerous factors including takeoff weight, ambient air temperature, declared runway distances, runway elevation and runway obstacle clearance criteria. Therefore the amount of thrust reduction varies from flight to flight.

As they can have a profound effect upon departure noise contours, modellers should take reasonable account of reduced thrust operations and, to make best possible provision, to seek practical advice from operators.

If such advice is not available it is still advisable to make some allowance by alternative means. It is impractical to mirror the operators' calculations for noise modelling purposes; nor would they be appropriate alongside the conventional simplifications and approximations which are made for the purposes of calculating long term average noise levels. As a practicable alternative the following guidance is provided. It should be emphasised that considerable research is ongoing in this area and thus, this guidance is subject to change.

Analysis of FDR data has shown that the level of thrust reduction is strongly correlated with ratio of the actual takeoff weight to the Regulated Takeoff Weight (RTOW), down to a fixed lower limit ⁽¹⁾; i.e.

$$F_n/\delta = (F_n/\delta)_{max} \cdot W/W_{RTOW} \quad (B-7)$$

where $(F_n/\delta)_{max}$ is the maximum rated thrust, W is the actual gross take-off weight and W_{RTOW} is the Regulated Takeoff Weight.

The RTOW is the maximum takeoff weight that can be safely used, whilst satisfying takeoff field length, engine-out and obstacle requirements. It is a function of the available runway length, airfield elevation, temperature, headwind, and flap angle. This information can be obtained from operators and should be more readily available than data on actual levels of reduced thrust. Alternatively, it may be computed using data contained in aircraft flight manuals.

Reduced Climb Thrust

When employing reduced take-off thrust, operators often, but not always, reduce climb thrust from below maximum levels ⁽²⁾. This prevents situations occurring where, at the end of the initial climb at take-off thrust, power has to be increased rather than cut back. However, it is more difficult to establish a rationale for a common basis here. Some operators use fixed detents below maximum climb thrust, sometimes referred to as Climb 1 and Climb 2, typically reducing climb thrust by 10 and 20 percent respectively relative to maximum. It is recommended that whenever reduced takeoff thrust is used, climb thrust levels also be reduced by 10 percent.

B3 VERTICAL PROFILES OF AIR TEMPERATURE, PRESSURE, DENSITY AND WINDSPEED

For the purposes of this document, the variations of temperature, pressure and density with height above mean sea level are taken to be those of the International Standard Atmosphere. The methodologies described below have been validated for aerodrome altitudes up to 4 000 ft above sea level and for air temperatures up to 43 °C (109 °F).

Although, in reality, mean wind velocity varies with both height and time, it is not usually practicable to take account of this for noise contour modelling purposes. Instead, the flight performance equations given below are based on the common assumption that the aeroplane is heading directly into a (default) headwind of 8 kt at all times — regardless of compass bearing (although no explicit account of mean wind velocity is taken in sound propagation calculations). Methods for adjusting the results for other headwind speeds are provided.

B4 THE EFFECTS OF TURNS

The remainder of this appendix explains how to calculate the required properties of the segments joining the profile points s, z that define the two-dimensional flight path in the vertical plane above the ground track. Segments are defined in sequence in the direction of motion. At the end of any one segment (or at the start of roll in the case of the first for a departure) where the operational parameters and the next procedural step are defined, the need is to calculate the climb angle and track distance to the point where the required height and/or speed are reached.

⁽¹⁾ Airworthiness authorities normally stipulate a lower thrust limit, often 25 percent below maximum.

⁽²⁾ To which thrust is reduced after the initial climb at take-off power.

If the track is straight, this will be covered by a single profile segment, the geometry of which can then be determined directly (albeit sometimes with a degree of iteration). But if a turn starts or ends, or changes in radius or direction, before the required end-conditions are reached, a single segment would be insufficient because the aircraft lift and drag change with bank angle. To account for the effects of the turn on the climb, additional profile segments are required to implement the procedural step — as follows.

The construction of the ground track is described in Section 2.7.13 of the text. This is done independently of any aircraft flight profile (although with care not to define turns that could not be flown under normal operating constraints). But as the flight profile — height and speed as a function of track distance — is affected by turns so that the flight profile cannot be determined independently of the ground track.

To maintain speed in a turn the aerodynamic wing lift has to be increased, to balance centrifugal force as well as the aircraft weight. This in turn increases drag and, consequently the propulsive thrust required. The effects of the turn are expressed in the performance equations as functions of bank angle ϵ which, for an aircraft in level flight turning at constant speed on a circular path, is given by

$$\epsilon = \tan^{-1} \left\{ \frac{2,85 \cdot V^2}{r \cdot g} \right\} \quad (\text{B-8})$$

where V is the groundspeed, kt
 r is the turn radius, ft
 and g is the acceleration due to gravity, ft/s²

All turns are assumed to have a constant radius and second-order effects associated with non-level flight paths are disregarded; bank angles are based on the turn radius r of the ground track only.

To implement a procedural step a provisional profile segment is first calculated using the bank angle ϵ at the start point — as defined by equation B-8 for the track segment radius r . If the calculated length of the provisional segment is such that it does not cross the start or end of a turn, the provisional segment is confirmed and attention turns to the next step.

But if the provisional segment crosses one or more starts or ends of turns (where ϵ changes) ⁽¹⁾, the flight parameters at the first such point are estimated by interpolation (see Section 2.7.13), saved along with its coordinates as end-point values, and the segment truncated. The second part of the procedural step is then applied from that point — once more assuming provisionally that it can be completed in a single segment with the same end conditions but with the new start point and new bank angle. If this second segment then passes another change of turn radius/direction, a third segment will be required — and so on until the end-conditions are achieved.

Approximate method

It will be apparent that accounting fully for the effects of turns, as described above, involves considerable computational complexity because the climb profile of any aircraft has to be calculated separately for each ground track that it follows. But changes to the vertical profile caused by turns usually have a markedly smaller influence on the contours than the changes of bank angle, and some users may prefer to avoid the complexity — at the cost of some loss of precision — by disregarding the effects of turns on profiles while still accounting for the bank angle in the calculation of lateral sound emission (see Section 2.7.19). Under this approximation profile points for a particular aircraft operation are calculated once only, assuming a straight ground track (for which $\epsilon = 0$).

⁽¹⁾ To avoid contour discontinuities caused by instantaneous changes of bank angle at the junctions between straight and turning flight, sub-segments are introduced into the noise calculations to allow linear transitions of bank angle over the first and last 5° of the turn. These are not necessary in the performance calculations; the bank angle is always given by equation B-8.

B5 TAKEOFF GROUND ROLL

Take-off thrust accelerates the aeroplane along the runway until lift-off. Calibrated airspeed is then assumed to be constant throughout the initial part of the climbout. Landing gear, if retractable, is assumed to be retracted shortly after lift-off.

For the purpose of this document, the actual takeoff ground-roll is approximated by an equivalent take-off distance (into a default headwind of 8 kt), s_{TO8} , defined as shown in **Figure B-1**, as the distance along the runway from brake release to the point where a straight line extension of the initial landing-gear-retracted climb flight path intersects the runway.

Figure B-1

Equivalent takeoff distance

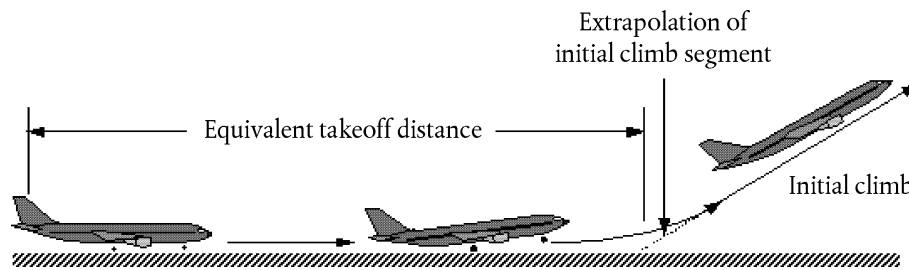

On a level runway, the equivalent takeoff ground-roll distance s_{TO8} in feet is determined from

$$s_{TO8} = \frac{B_8 \cdot \vartheta \cdot (W/\delta)^2}{N \cdot (F_n/\delta)} \tag{B-9}$$

where

B_8 is a coefficient appropriate to a specific aeroplane/flap-deflection combination for the ISA reference conditions, including the 8-knot headwind, ft/lbf

W is the aeroplane gross weight at brake release, lbf

N is the number of engines supplying thrust.

Note: Since equation B-9 accounts for variation of thrust with airspeed and runway elevation, for a given aeroplane the coefficient B_8 depends only on flap deflection.

For headwind other than the default 8 kt, the takeoff ground-roll distance is corrected by using:

$$s_{TOw} = s_{TO8} \cdot \frac{(V_c - w)^2}{(V_c - 8)^2} \tag{B-10}$$

where

s_{TOw} is the ground-roll distance corrected for headwind w , ft

V_c (in this equation) is the calibrated speed at takeoff rotation, kt

w is the headwind, kt

The takeoff ground-roll distance is also corrected for runway gradient as follows:

$$S_{TOG} = S_{TOW} \cdot \frac{a}{(a - g \cdot G_R)} \quad (B-11)$$

where

S_{TOG} is the ground-roll distance (ft) corrected for headwind and runway gradient,

a is the average acceleration along the runway, equal to $(V_C \cdot \sqrt{\sigma})^2 / (2 \cdot s_{TOW})$, ft/s²

G_R is the runway gradient; positive when taking-off uphill

B6 CLIMB AT CONSTANT SPEED

This type of segment is defined by the aeroplane's calibrated airspeed, flap setting, and the height and bank angle at its end, together with the headwind speed (default 8 kt). As for any segment, the segment start parameters including corrected net thrust are put equal to those at the end of the preceding segment — there are no discontinuities (except of flap angle and bank angle which, in these calculations, are allowed to change in steps). The net thrusts at the segment end are first calculated using the appropriate equation from B-1 to B-5. The average geometric climb angle g (see **Figure B-1**) is then given by

$$\gamma = \arcsin \left(K \cdot \left[N \cdot \frac{\overline{F_n / \delta}}{\overline{W / \delta}} - \frac{R}{\cos \varepsilon} \right] \right) \quad (B-12)$$

where the over-bars denote mid-segment values (= average of start-point and end-point values — generally the mid-segment values) and

K is a speed-dependent constant equal to 1,01 when $V_C \leq 200$ kt or 0,95 otherwise. This constant accounts for the effects on climb gradient of climbing into an 8-knot headwind and the acceleration inherent in climbing at constant calibrated airspeed (true speed increases as air density diminishes with height).

R is the ratio of the aeroplane's drag coefficient to its lift coefficient appropriate to the given flap setting. The landing gear is assumed to be retracted.

ε Bank angle, radians

The climb angle is corrected for headwind w using:

$$\gamma_w = \gamma \cdot \frac{(V_C - 8)}{(V_C - w)} \quad (B-13)$$

where γ_w is the average climb angle corrected for headwind.

The distance that the aeroplane traverses along the ground track, Δ_s , while climbing at angle γ_w from an initial altitude h_1 to a final altitude h_2 is given by

$$\Delta_s = \frac{(h_2 - h_1)}{\tan \gamma_w} \quad (B-14)$$

As a rule, two distinct phases of a departure profile involve climb at constant airspeed. The first, sometime referred to as the *initial climb segment* is immediately after lift-off, where safety requirements dictate that the aeroplane is flown at a minimum airspeed of least the takeoff safety speed. This is a regulated speed and should be achieved by 35 ft above the runway during normal operation. However, it is common practice to maintain an initial climb speed slightly beyond the takeoff safety speed, usually by 10-20 kt, as this tends to improve the initial climb gradient achieved. The second is after flap retraction and initial acceleration, referred to as *continuing climb*.

During the *initial climb*, the airspeed is dependent on the takeoff flap setting and the aeroplane gross weight. The calibrated initial climb speed V_{CTO} is calculated using the first order approximation:

$$V_{CTO} = C \cdot \sqrt{W} \quad (\text{B-15})$$

where C is a coefficient appropriate to the flap setting (kt/ $\sqrt{\text{lbf}}$), read from the ANP database.

For *continuing climb* after acceleration, the calibrated airspeed is a user input parameter.

B7 POWER CUTBACK (TRANSITION SEGMENT)

Power is reduced, or *cut back*, from take-off setting at some point after takeoff in order to extend engine life and often to reduce noise in certain areas. Thrust is normally cut back during either a constant speed climb segment (**Section B6**) or an acceleration segment (**Section B8**). As it is a relatively brief process, typically of only 3-5 seconds' duration, is it modelled by adding a 'transition segment' to the primary segment. This is usually taken to cover a horizontal ground distance of 1 000 ft (305 m).

Amount of thrust reduction

In normal operation the engine thrust is reduced to the maximum climb thrust setting. Unlike the take-off thrust, climb thrust can be sustained indefinitely, usually in practice until the aeroplane has reached its initial cruise altitude. The maximum climb thrust level is determined with equation B-1 using the manufacturer supplied maximum thrust coefficients. However, noise abatement requirements may call for additional thrust reduction, sometimes referred to as a deep cutback. For safety purposes the maximum thrust reduction is limited (!) to an amount determined by the performance of the aeroplane and the number of engines.

The minimum 'reduced-thrust' level is sometimes referred to as the engine-out 'reduced thrust':

$$(F_n/\delta)_{\text{engine.out}} = \frac{(W/\delta_2)}{(N-1)} \cdot \left[\frac{\sin(\arctan(0,01 \cdot G'))}{K} + \frac{R}{\cos \varepsilon} \right] \quad (\text{B-16})$$

where

δ_2 is the pressure ratio at altitude h_2

G' is the engine-out percentage climb gradient:

= 0 % for aeroplanes with automatic thrust restoration systems; otherwise,

= 1,2 % for 2-engine aeroplane

= 1,5 % for 3-engine aeroplane

= 1,7 % for 4-engine aeroplane

(!) 'Noise Abatement Procedures', ICAO Document 8168 'PANS-OPS' Vol.1 Part V, Chapter 3, ICAO 2004.

Constant speed climb segment with cutback

The climb segment gradient is calculated using equation B-12, with thrust calculated using either B-1 with maximum climb coefficients, or B-16 for reduced thrust. The climb segment is then broken into two sub-segments, both having the same climb angle. This is illustrated in **Figure B-2**.

Figure B-2

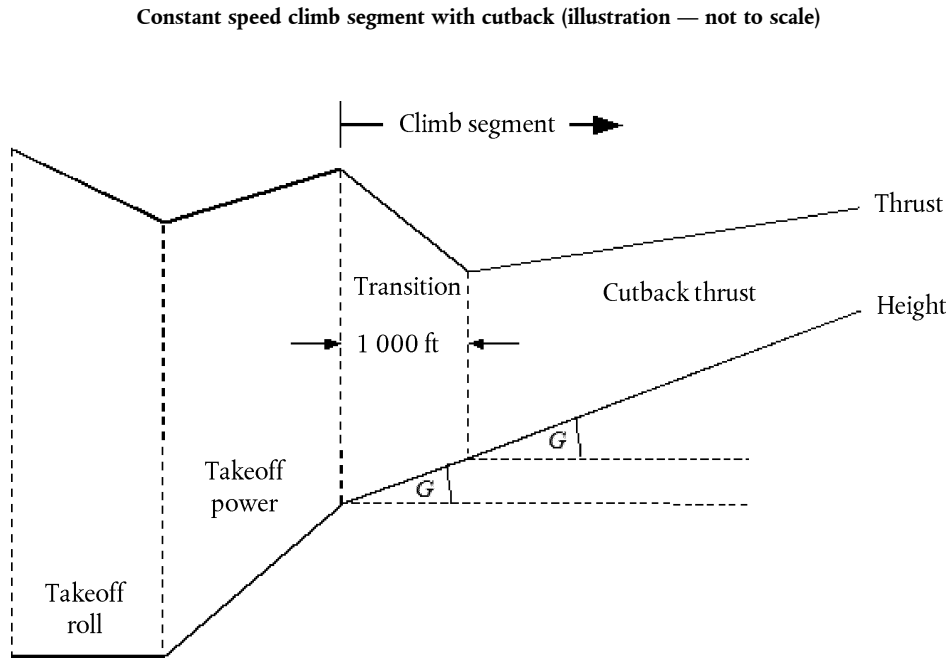

The first sub-segment is assigned a 1 000 ft (304 m) ground distance, and the corrected net thrust per engine at the end of 1 000 ft is set equal to the cutback value. (If the original horizontal distance is less than 2 000 ft, one half of the segment is used to cutback thrust.) The final thrust on the second sub-segment is also set equal to the cutback thrust. Thus, the second sub-segment is flown at constant thrust.

B8 ACCELERATING CLIMB AND FLAP RETRACTION

This usually follows the initial climb. As for all flight segments, the start-point altitude h_1 , true airspeed V_{T1} , and thrust $(F_n/\delta)_1$ are those from the end of the preceding segment. The end-point calibrated airspeed V_{C2} and the average climb rate ROC are user inputs (bank angle ϵ is a function of speed and radius of turn). As they are interdependent, the end altitude h_2 , end true airspeed V_{T2} , end thrust $(F_n/\delta)_2$ and segment track length Δs have to be calculated by iteration; the end altitude h_2 is guessed initially and then recalculated repeatedly using equations B-16 and B-17 until the difference between successive estimates is less than a specified tolerance, e.g. one foot. A practical initial estimate is $h_2 = h_1 + 250$ feet.

The segment track length (horizontal distance covered) is estimated as:

$$S_{seg} = 0,95 \cdot k^2 \cdot (V_{T2}^2 - V_{T1}^2) / 2 (\alpha_{max} - G \cdot g) \tag{B-17}$$

where

0,95 is a factor to account for effect of 8 kt headwind when climbing at 160 kt

k is a constant to convert knots to ft/sec = 1,688 ft/s per kt

V_{T2} = true airspeed at segment end, kt: $V_{T2} = V_{C2}/\sqrt{\sigma_2}$

where σ_2 = air density ratio at end altitude h_2

a_{max} = maximum acceleration in level flight (ft/s²)

$$= g \left[N \cdot \overline{F_n/\delta} / (\overline{W/\delta}) - R / \cos \epsilon \right]$$

G = climb gradient $\approx \frac{ROC}{60 \cdot k \cdot V_T}$

where ROC = climb rate, ft/min

Using this estimate of Δs , the end altitude h_2' is then re-estimated using:

$$h_2' = h_1 + s \cdot G/0,95 \quad (B-18)$$

As long as the error $|h_2' - h_2|$ is outside the specified tolerance, the steps B-17 and B-18 are repeated using the current iteration segment-end values of altitude h_2 , true airspeed V_{T2} , corrected net thrust per engine $(F_n/\delta)_2$. When the error is within the tolerance, the iterative cycle is terminated and the acceleration segment is defined by the final segment-end values.

Note: If during the iteration process $(a_{max} - G \cdot g) < 0,02$ g, the acceleration may be too small to achieve the desired V_{C2} in a reasonable distance. In this case, the climb gradient can be limited to $G = a_{max}/g - 0,02$, in effect reducing the desired climb rate in order to maintain acceptable acceleration. If $G < 0,01$ it should be concluded there is not enough thrust to achieve the acceleration and climb rate specified; the calculation should be terminated and the procedure steps revised (¹).

The acceleration segment length is corrected for headwind w by using:

$$\Delta S_w = \Delta_s \cdot \frac{(V_T - w)}{(V_T - g)} \quad (B-19)$$

Accelerating segment with cutback

Thrust cutback is inserted into an acceleration segments in the same way as for a constant speed segment; by turning its first part into a transition segment. The cutback thrust level is calculated as for the constant-speed cutback thrust procedure, using equation B-1 only. Note it is not generally possible to accelerate and climb whilst maintaining the minimum engine-out thrust setting. The thrust transition is assigned a 1 000 ft (305 m) ground distance, and the corrected net thrust per engine at the end of 1 000 ft is set equal to the cutback value. The speed at the end of the segment is determined by iteration for a segment length of 1 000 ft. (If the original horizontal distance is less than 2 000 ft, one half of the segment is used for thrust change.) The final thrust on the second sub-segment is also set equal to the cutback thrust. Thus, the second sub-segment is flown at constant thrust.

B9 ADDITIONAL CLIMB AND ACCELERATION SEGMENTS AFTER FLAP RETRACTION

If additional acceleration segments are included in the climbout flight path, equations B-12 to B-19 should be used again to calculate the ground-track distance, average climb angle, and height gain for each. As before, the final segment height must be estimated by iteration.

B10 DESCENT AND DECELERATION

Approach flight normally requires the aeroplane to descend and decelerate in preparation for the final approach segment where the aeroplane is configured with approach flap and gear down. The flight mechanics are unchanged from the departure case; the main difference is that the height and speed profile is generally known, and it is the engine thrust levels that must be estimated for each segment. The basic force balance equation is:

$$F_n/\delta = W \cdot \frac{R \cdot \cos \gamma + \sin \gamma + a/g}{N \cdot \delta} \quad (B-20)$$

(¹) In either case the computer model should be programmed to inform the user of the inconsistency.

Equation B-20 may be used in two distinct ways. First the aeroplane speeds at the start and end of a segment may be defined, along with a descent angle (or level segment distance) and initial and final segment altitudes. In this case the deceleration may be calculated using:

$$\alpha = \frac{(V_2/\cos \gamma)^2 - (V_1/\cos \gamma)^2}{(2 \cdot \Delta s/\cos \gamma)} \quad (\text{B-21})$$

where Δs is the ground distance covered and V_1 and V_2 are the initial and final groundspeeds calculated using

$$V = \frac{V_C \cdot \cos \gamma}{\sqrt{\sigma}} - w \quad (\text{B-22})$$

Equations B-20, B-21 and B-22 confirm that whilst decelerating over a specified distance at a constant rate of descent, a stronger headwind will result in more thrust being required to maintain the same deceleration, whilst a tailwind will require less thrust to maintain the same deceleration.

In practice most, if not all decelerations during approach flight are performed at idle thrust. Thus for the second application of equation B-20, thrust is defined at an idle setting and the equation is solved iteratively to determine (1) the deceleration and (2) the height at the end of the deceleration segment — in a similar manner to the departure acceleration segments. In this case, deceleration distance can be very different with head and tail winds and it is sometimes necessary to reduce the descent angle in order to obtain reasonable results.

For most aeroplanes, idle thrust is not zero and, for many, it is also a function of flight speed. Thus, equation B-20 is solved for the deceleration by inputting an idle thrust; the idle thrust is calculated using an equation of the form:

$$(F_n/\delta)_{idle} = E_{idle} + F_{idle} \cdot V_C + G_{A,idle} \cdot h + G_{B,idle} \cdot h^2 + H_{idle} \cdot T \quad (\text{B-23})$$

where $(E_{idle}, F_{idle}, G_{A,idle}, G_{B,idle}$ and $H_{idle})$ are idle thrust engine coefficients available in the ANP database.

B11 LANDING APPROACH

The landing approach calibrated airspeed, V_{CA} , is related to the landing gross weight by an equation of the same form as equation B-11, namely

$$V_{CA} \approx D \cdot \sqrt{W} \quad (\text{B-24})$$

where the coefficient D (kt/ $\sqrt{\text{lb}}$) corresponds to the landing flap setting.

The corrected net thrust per engine during descent along the approach glideslope is calculated by solving equation B-12 for the landing weight W and a drag-to-lift ratio R appropriate for the flap setting with landing gear extended. The flap setting should be that typically used in actual operations. During landing approach, the glideslope descent angle γ may be assumed constant. For jet-powered and multi-engine propeller aeroplanes, γ is typically -3° . For single-engine, propeller-powered aeroplanes, γ is typically -5° .

The average corrected net thrust is calculated by inverting equation B-12 using $K = 1.03$ to account for the deceleration inherent in flying a descending flight path into an 8-knot reference headwind at the constant calibrated airspeed given by equation B-24, i.e.

$$\overline{F_n/\delta} = \frac{\overline{W/\delta}}{N} \cdot \left(R + \frac{\sin \gamma}{1.03} \right) \quad (\text{B-25})$$

Nr. 1

3. september 2019

For headwinds other than 8 kt, average corrected net thrust becomes

$$\overline{(F_n / \delta)}_w = \overline{F_n / \delta} + 1,03 \cdot \overline{W / \delta} \cdot \frac{\sin \gamma \cdot (w - 8)}{N \cdot V_{Cl}} \quad (\text{B-26})$$

The horizontal distance covered is calculated by:

$$\Delta_s = \frac{(h_2 - h_1)}{\tan \gamma} \quad (\text{B-27})$$

(positive since $h_1 > h_2$ and γ is negative).

Appendix C

Modelling of lateral ground track spreading

It is recommended that, in the absence of radar data, lateral ground track dispersion be modelled on the assumption that the spread of tracks perpendicular to the backbone track follows a Gaussian normal distribution. Experience has shown that this assumption is a reasonable one in most cases.

Assuming a Gaussian distribution with a standard deviation S , illustrated in **Figure C-1**, about 98,8 percent of all movements fall within boundaries of $\pm 2,5 \cdot S$ (i.e. within a swathe of width of $5 \cdot S$).

Figure C-1

Subdivision of a ground track into 7 subtracks

(The width of the swathe is 5 times the standard deviation of the ground track spreading)

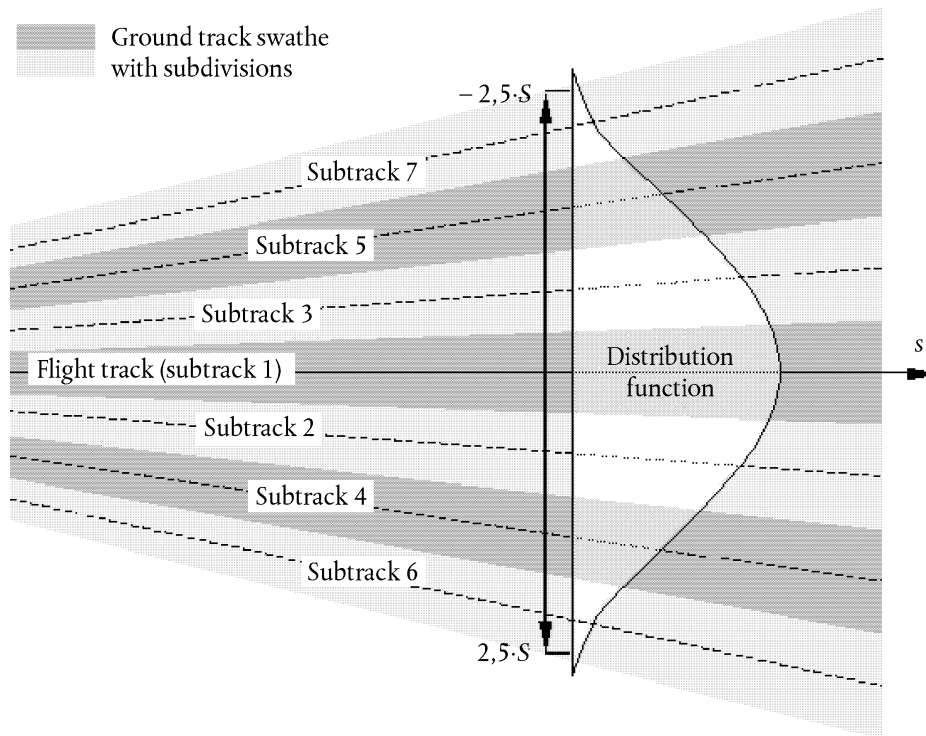

A Gaussian distribution can normally be modelled adequately using 7 discrete sub-tracks evenly spaced between the $\pm 2,5 \cdot S$ boundaries of the swathe as shown in **Figure C-1**.

However, the adequacy of the approximation depends on the relationship of the sub-track track separation to the heights of the aircraft above. There may be situations (very tight or very dispersed tracks) where a different number of subtracks is more appropriate. Too few subtracks cause 'fingers' to appear in the contour. **Tables C-1** and **C-2** show the parameters for a subdivision into between 5 and 13 subtracks. **Table C-1** shows the location of the particular subtracks, **Table C-2** the corresponding percentage of movements on each subtrack.

Table C-1

Location of 5, 7, 9, 11 or 13 subtracks

(The overall width of the swathe (containing 98 % of all movements) is 5 times the standard deviation)

Subtrack number	Location of subtracks for subdivision into				
	5 subtracks	7 subtracks	9 subtracks	11 subtracks	13 subtracks
12/13					± 2,31·S
10/11				± 2,27·S	± 1,92·S
8/9			± 2,22·S	± 1,82·S	± 1,54·S
6/7		± 2,14·S	± 1,67·S	± 1,36·S	± 1,15·S
4/5	± 2,00·S	± 1,43·S	± 1,11·S	± 0,91·S	± 0,77·S
2/3	± 1,00·S	± 0,71·S	± 0,56·S	± 0,45·S	± 0,38·S
1	0	0	0	0	0

Table C-2

Percentage of movements on 5, 7, 9, 11 or 13 subtracks

(The overall width of the swathe (containing 98 % of all movements) is 5 times the standard deviation)

Subtrack number	Percentage of movements on subtrack for subdivision into				
	5 subtracks	7 subtracks	9 subtracks	11 subtracks	13 subtracks
12/13					1,1 %
10/11				1,4 %	2,5 %
8/9			2,0 %	3,5 %	4,7 %
6/7		3,1 %	5,7 %	7,1 %	8,0 %
4/5	6,3 %	10,6 %	12,1 %	12,1 %	11,5 %
2/3	24,4 %	22,2 %	19,1 %	16,6 %	14,4 %
1	38,6 %	28,2 %	22,2 %	18,6 %	15,6 %

Appendix D

Recalculation of NPD-data for non-reference conditions

The noise level contributions from each segment of the flight path are derived from the NPD-data stored in the international ANP database. However it must be noted that these data have been normalised using average atmospheric attenuation rates defined in SAE AIR-1845. Those rates are averages of values determined during aircraft noise certification testing in Europe and the USA. The wide variation of atmospheric conditions (temperature and relative humidity) in those tests is shown in **Figure D-1**.

Figure D-1

Meteorological conditions recorded during noise certification tests

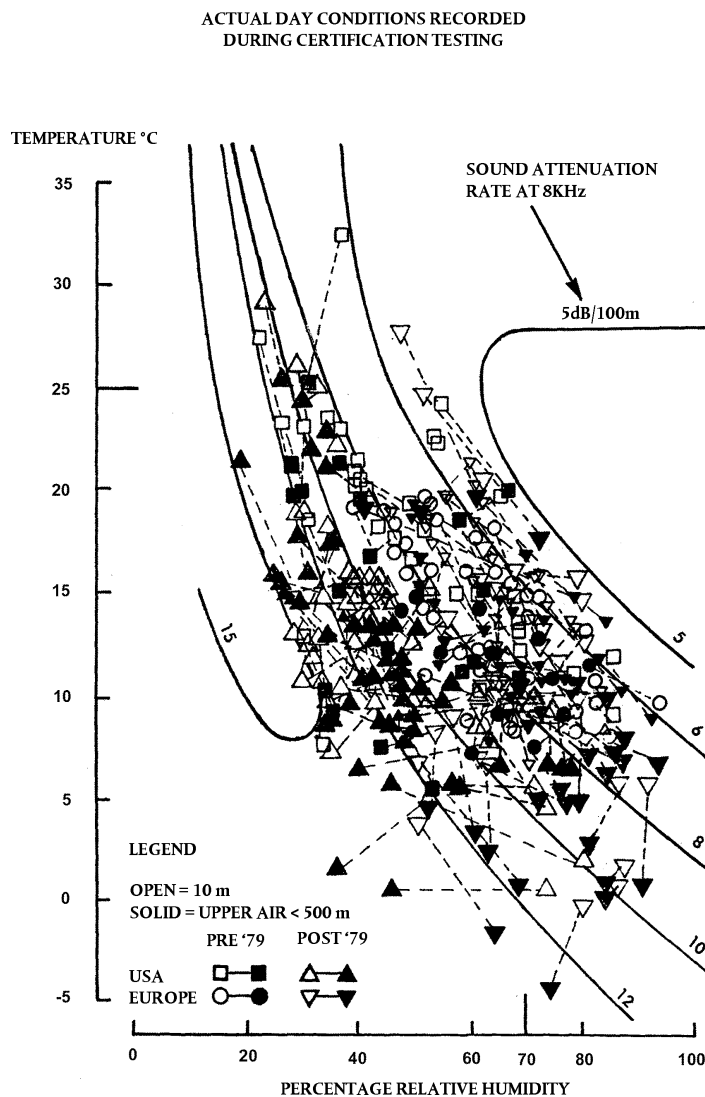

The curves overlaid on **Figure D-1**, calculated using an industry standard atmospheric attenuation model ARP 866A, illustrate that across the test conditions a substantial variation of high frequency (8 kHz) sound absorption would be expected (although the variation of overall absorption would be rather less).

Because the attenuation rates, given in **Table D-1**, are arithmetic averages, the complete set cannot be associated with a single reference atmosphere (i.e. with specific values of temperature and relative humidity). They can only be thought of as properties of a purely notional atmosphere — referred to as the 'AIR-1845 atmosphere'.

Table D-1

Average atmospheric attenuation rates used to normalise NPD data in the ANP database

Centre frequency of 1/3-octave band [Hz]	Attenuation rate [dB/100 m]	Centre frequency of 1/3-octave band [Hz]	Attenuation rate [dB/100 m]
50	0,033	800	0,459
63	0,033	1 000	0,590
80	0,033	1 250	0,754
100	0,066	1 600	0,983
125	0,066	2 000	1,311
160	0,098	2 500	1,705
200	0,131	3 150	2,295
250	0,131	4 000	3,115
315	0,197	5 000	3,607
400	0,230	6 300	5,246
500	0,295	8 000	7,213
630	0,361	10 000	9,836

The attenuation coefficients in **Table D-1** may be assumed valid over reasonable ranges of temperature and humidity. However, to check whether adjustments may be necessary, ARP-866A should be used to calculate average atmospheric absorption coefficients for the average airport temperature T and relative humidity RH . Where, from a comparison of these with those in **Table D-1**, it is judged that adjustment is required the following methodology should be used.

The ANP database provides the following NPD data for each power setting:

- maximum sound level versus slant distance, $L_{max}(d)$
- time integrated level versus distance for the reference airspeed, $L_E(d)$, and
- unweighted reference sound spectrum at a slant distance of 305 m (1 000 ft), $L_{n,ref}(d_{ref})$ where n = frequency band (ranging from 1 to 24 for 1/3-octave bands with centre frequencies from 50 Hz to 10 kHz),

all data being normalised to the AIR-1845 atmosphere.

Adjustment of the NPD curves to user-specified conditions T and RH is performed in three steps:

1. First the reference spectrum is corrected to remove the SAE AIR-1845 atmospheric attenuation $\alpha_{n,ref}$:

$$L_n(d_{ref}) = L_{n,ref}(d_{ref}) + \alpha_{n,ref} \cdot d_{ref} \quad (D-1)$$

where $L_n(d_{ref})$ is the unattenuated spectrum at $d_{ref} = 305$ m and $\alpha_{n,ref}$ is the coefficient of atmospheric absorption for the frequency band n taken from **Table D-1** (but expressed in dB/m).

2. Next the corrected spectrum is adjusted to each of the 10 standard NPD distances d_i using attenuation rates for both (i) the SAE AIR-1845 atmosphere and (ii) the user-specified atmosphere (based on SAE ARP-866A).

- (i) For the SAE AIR-1845 atmosphere:

$$L_{n,ref}(d_i) = L_n(d_{ref}) - 20 \cdot \lg(d_i/d_{ref}) - \alpha_{n,ref} \cdot d_i \quad (D-2)$$

- (ii) For the user atmosphere:

$$L_{n,866A}(T,RH,d_i) = L_n(d_{ref}) - 20 \cdot \lg(d_i/d_{ref}) - \alpha_{n,866A}(T,RH) \cdot d_i \quad (D-3)$$

where $\alpha_{n,866A}$ is the coefficient of atmospheric absorption for the frequency band n (expressed in dB/m) calculated using SAE ARP-866A with temperature T , and relative humidity RH .

3. At each NPD distance d_i the two spectra are A-weighted and decibel-summed to determine the resulting A-weighted levels $L_{A,866A}$ and $L_{A,ref}$ — which are then subtracted arithmetically:

$$\Delta L(T,RH,d_i) = L_{A,866A} - L_{A,ref} = 10 \cdot \lg \sum_{n=1}^{24} 10^{(L_{n,866A}(T,RH,d_i) - A_n)/10} - 10 \cdot \lg \sum_{n=1}^{24} 10^{(L_{n,ref}(d_i) - A_n)/10} \quad (D-4)$$

The increment ΔL is the difference between the NPDs in the user-specified atmosphere and the reference atmosphere. This is added to the ANP database NPD data value to derive the adjusted NPD data.

Applying ΔL to adjust both L_{max} and L_E NPDs effectively assumes that different atmospheric conditions affect the reference spectrum only and have no effect on the shape of the level-time-history. This may be considered valid for typical propagation ranges and typical atmospheric conditions.

Appendix E

The finite segment correction

This appendix outlines the derivation of the finite segment correction and the associated energy fraction algorithm described in Section 2.7.19.

E1 GEOMETRY

The energy fraction algorithm is based on the sound radiation of a 'fourth-power' 90-degree dipole sound source. This has directional characteristics which approximate those of jet aircraft sound, at least in the angular region that most influences sound event levels beneath and to the side of the aircraft flight path.

Figure E-1

Geometry between flight path and observer location O

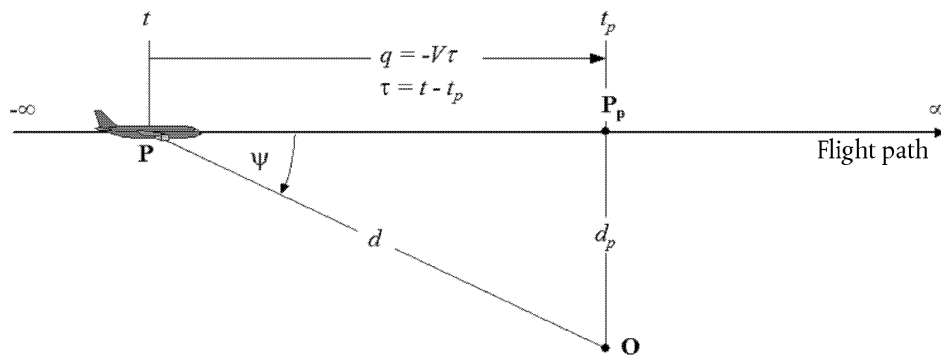

Figure E-1 illustrates the geometry of sound propagation between the flight path and the observer location **O**. The aircraft at **P** is flying in still uniform air with a constant speed on a straight, level flight path. Its closest point of approach to the observer is **P_p**. The parameters are:

- d distance from the observer to the aircraft
- d_p perpendicular distance from the observer to the flight path (slant distance)
- q distance from **P** to **P_p** = $-V \cdot \tau$
- V speed of the aircraft
- t time at which the aircraft is at point **P**
- t_p time at which the aircraft is located at the point of closest approach **P_p**
- τ flight time = time relative to time at **P_p** = $t - t_p$
- ψ angle between flight path and aircraft-observer vector

It should be noted that, since the flight time τ relative to the point of closest approach is negative when the aircraft is before the observer position (as shown in **Figure E-1**), the relative distance q to the point of closest approach becomes positive in that case. If the aircraft is ahead of the observer, q becomes negative.

E2 ESTIMATION OF THE ENERGY FRACTION

The basic concept of the energy fraction is to express the noise exposure E produced at the observer position from a flight path segment $\mathbf{P}_1\mathbf{P}_2$ (with a start-point \mathbf{P}_1 and an end-point \mathbf{P}_2) by multiplying the exposure E_∞ from the whole infinite path flyby by a simple factor — the *energy fraction* factor F :

$$E = F \cdot E_\infty \quad (\text{E-1})$$

Since the exposure can be expressed in terms of the time-integral of the mean-square (weighted) sound pressure level, i.e.

$$E = \text{const} \cdot \int p^2(\tau) d\tau \quad (\text{E-2})$$

to calculate E , the mean-square pressure has to be expressed as a function of the known geometric and operational parameters. For a 90° dipole source,

$$p^2 = p_p^2 \cdot \frac{d^2}{d_p^2} \cdot \sin^2\psi = p_p^2 \cdot \frac{d^4}{d_p^4} \quad (\text{E-3})$$

where p^2 and p_p^2 are the observed mean-square sound pressures produced by the aircraft as it passes points \mathbf{P} and \mathbf{P}_p .

This relatively simple relationship has been found to provide a good simulation of jet aircraft noise, even though the real mechanisms involved are extremely complex. The term d_p^2/d^2 in equation E-3 describes just the mechanism of spherical spreading appropriate to a point source, an infinite sound speed and a uniform, non-dissipative atmosphere. All other physical effects — source directivity, finite sound speed, atmospheric absorption, Doppler-shift etc. — are implicitly covered by the $\sin^2\psi$ term. This factor causes the mean square pressure to decrease inversely as d^4 ; whence the expression 'fourth power' source.

Introducing the substitutions

$$d^2 = d_p^2 + q^2 = d_p^2 + (V \cdot \tau)^2 \quad \text{and} \quad \left(\frac{d}{d_p}\right)^2 = 1 + \left(\frac{V \cdot \tau}{d_p}\right)^2$$

the mean-square pressure can be expressed as a function of time (again disregarding sound propagation time):

$$p^2 = p_p^2 \cdot \left(1 + \left(\frac{V \cdot \tau}{d_p}\right)^2\right)^{-2} \quad (\text{E-4})$$

Putting this into equation (E-2) and performing the substitution

$$\alpha = \frac{V \cdot \tau}{d_p} \quad (\text{E-5})$$

the sound exposure at the observer from the flypast between the time interval $[\tau_1, \tau_2]$ can be expressed as

$$E = \text{const} \cdot p_p^2 \cdot \frac{d_p}{V} \cdot \int_{\alpha_1}^{\alpha_2} \frac{1}{(1 + \alpha^2)^2} d\alpha \quad (\text{E-6})$$

The solution of this integral is:

$$E = \text{const} \cdot p_p^2 \cdot \frac{d_p}{V} \cdot \frac{1}{2} \left(\frac{\alpha_2}{1 + \alpha_2^2} + \arctan \alpha_2 - \frac{\alpha_1}{1 + \alpha_1^2} - \arctan \alpha_1 \right) \quad (\text{E-7})$$

Integration over the interval $[-\infty, +\infty]$ (i.e. over the whole infinite flight path) yields the following expression for the total exposure E_∞ :

$$E_\infty = \text{const} \cdot \frac{\pi}{2} \cdot p_p^2 \cdot \frac{d_p}{V} \quad (\text{E-8})$$

and hence the energy fraction according to equation E-1 is

$$F = \frac{1}{\pi} \left(\frac{\alpha_2}{1 + \alpha_2^2} + \arctan \alpha_2 - \frac{\alpha_1}{1 + \alpha_1^2} - \arctan \alpha_1 \right) \quad (\text{E-9})$$

E3 CONSISTENCY OF MAXIMUM AND TIME INTEGRATED METRICS — THE SCALED DISTANCE

A consequence of using the simple dipole model to define the energy fraction is that it implies a specific theoretical difference ΔL between the event noise levels L_{\max} and L_E . If the contour model is to be internally consistent, this needs to equal the difference of the values determined from the NPD curves. A problem is that the NPD data are derived from actual aircraft noise measurements — which do not necessarily accord with the simple theory. The theory therefore needs an added element of flexibility. But in principal the variables α_1 and α_2 are determined by geometry and aircraft speed — thus leaving no further degrees of freedom. A solution is provided by the concept of a *scaled distance* d_λ as follows.

The exposure level $L_{E,\infty}$ as tabulated as a function of d_p in the ANP database for a reference speed V_{ref} can be expressed as

$$L_{E,\infty}(V_{\text{ref}}) = 10 \cdot \lg \left[\frac{\int_{-\infty}^{\infty} p^2 \cdot dt}{p_0^2 \cdot t_{\text{ref}}} \right] \quad (\text{E-10})$$

where p_0 is a standard reference pressure and t_{ref} is a reference time (= 1 s for SEL). For the actual speed V it becomes

$$L_{E,\infty}(V) = L_{E,\infty}(V_{\text{ref}}) + 10 \cdot \lg \left(\frac{V_{\text{ref}}}{V} \right) \quad (\text{E-11})$$

Similarly the maximum event level L_{\max} can be written

$$L_{\max} = 10 \cdot \lg \left[\frac{p_p^2}{p_0^2} \right] \quad (\text{E-12})$$

For the dipole source, using equations E-8, E-11 and E-12, noting that (from equations E-2 and E-8)

$\int_{-\infty}^{\infty} p^2 \cdot dt = \frac{\pi}{2} \cdot p_p^2 \cdot \frac{d_p}{V}$, the difference ΔL can be written:

$$\Delta L = L_{E,\infty} - L_{\max} = 10 \cdot \lg \left[\frac{V}{V_{\text{ref}}} \cdot \left(\frac{\pi p_p^2 d_p}{2 p_0^2 V} \right) \cdot \frac{1}{p_0^2 \cdot t_{\text{ref}}} \right] - 10 \cdot \lg \left[\frac{p_p^2}{p_0^2} \right] \quad (\text{E-13})$$

This can only be equated to the value of ΔL determined from the NPD data if the slant distance d_p used to calculate the energy fraction is substituted by a *scaled distance* d_λ given by

$$d_\lambda = \frac{2}{\pi} \cdot V_{\text{ref}} \cdot t_{\text{ref}} \cdot 10^{(L_{E,\infty} - L_{\max})/10} \quad (\text{E-14a})$$

or

$$d_\lambda = d_0 \cdot 10^{(L_{E,\infty} - L_{\max})/10} \quad \text{with} \quad d_0 = \frac{2}{\pi} \cdot V_{\text{ref}} \cdot t_{\text{ref}} \quad (\text{E-14b})$$

Replacing d_p by d_λ in equation E-5 and using the definition $q = V\tau$ from **Figure E-1** the parameters α_1 and α_2 in equation E-9 can be written (putting $q = q_1$ at the start-point and $q - \lambda = q_2$ at the endpoint of a flight path segment of length λ) as

$$\alpha_1 = \frac{-q_1}{d_\lambda} \text{ and } \alpha_2 = \frac{-q_1 + \lambda}{d_\lambda} \quad (\text{E-15})$$

Having to replace the slant actual distance by scaled distance diminishes the simplicity of the fourth-power 90 degree dipole model. But as it is effectively calibrated *in situ* using data derived from measurements, the energy fraction algorithm can be regarded as semi-empirical rather than a pure theoretical.

Appendix G

Database for railway source

This appendix presents the database for most of the existing railway noise sources to be used to calculate railway noise following the method described in 2.3 Railway noise.

Table G-1

Coefficients $L_{r,TR,i}$ and $L_{r,VEH,i}$ for rail and wheel roughness

Wavelength	$L_{r,VEH,i}$				
	Min	Max	Cast iron tread brake	Composite brake	Disk brake
1 000 mm	- 15,0	25,0	2,2	- 4,0	- 5,9
800 mm	- 15,0	25,0	2,2	- 4,0	- 5,9
630 mm	- 15,0	25,0	2,2	- 4,0	- 5,9
500 mm	- 15,0	25,0	2,2	- 4,0	- 5,9
400 mm	- 15,0	25,0	2,2	- 4,0	- 5,9
315 mm	- 15,0	25,0	2,2	- 4,0	- 5,9
250 mm	- 15,0	25,0	2,2	- 4,0	2,3
200 mm	- 15,0	25,0	2,2	- 4,0	2,8
160 mm	- 15,0	25,0	2,4	- 4,0	2,6
120 mm	- 15,0	25,0	0,6	- 4,0	1,2
100 mm	- 15,0	25,0	2,6	- 4,0	2,1
80 mm	- 15,0	25,0	5,8	- 4,3	0,9
63 mm	- 15,0	25,0	8,8	- 4,6	- 0,3
50 mm	- 15,0	25,0	11,1	- 4,9	- 1,6
40 mm	- 15,0	25,0	11,0	- 5,2	- 2,9
31,5 mm	- 15,0	25,0	9,8	- 6,3	- 4,9
25 mm	- 15,0	25,0	7,5	- 6,8	- 7,0
20 mm	- 15,0	25,0	5,1	- 7,2	- 8,6
16 mm	- 15,0	25,0	3,0	- 7,3	- 9,3
12 mm	- 15,0	25,0	1,3	- 7,3	- 9,5
10 mm	- 15,0	25,0	0,2	- 7,1	- 10,1
8 mm	- 15,0	25,0	- 0,7	- 6,9	- 10,3

Wavelength	$L_{r,VEHj}$				
	Min	Max	Cast iron tread brake	Composite brake	Disk brake
6,3 mm	- 15,0	25,0	- 1,2	- 6,7	- 10,3
5 mm	- 15,0	25,0	- 1,0	- 6,0	- 10,8
4 mm	- 15,0	25,0	0,3	- 3,7	- 10,9
3,2 mm	- 15,0	25,0	0,2	- 2,4	- 9,5
2,5 mm	- 15,0	25,0	1,3	- 2,6	- 9,5
2 mm	- 15,0	25,0	3,1	- 2,5	- 9,5
1,6 mm	- 15,0	25,0	3,1	- 2,5	- 9,5
1,2 mm	- 15,0	25,0	3,1	- 2,5	- 9,5
1 mm	- 15,0	25,0	3,1	- 2,5	- 9,5
0,8 mm	- 15,0	25,0	3,1	- 2,5	- 9,5

Wavelength	$L_{r,VEHj}$			
	Min	Max	EN ISO 3095:2013 (Well maintained and very smooth)	Average network (Normally maintained smooth)
1 000 mm	- 15,0	22,0	17,1	11,0
800 mm	- 15,0	22,0	17,1	11,0
630 mm	- 15,0	22,0	17,1	11,0
500 mm	- 15,0	22,0	17,1	11,0
400 mm	- 15,0	22,0	17,1	11,0
315 mm	- 15,0	22,0	15,0	10,0
250 mm	- 15,0	22,0	13,0	9,0
200 mm	- 15,0	22,0	11,0	8,0
160 mm	- 15,0	22,0	9,0	7,0
120 mm	- 15,0	22,0	7,0	6,0
100 mm	- 15,0	22,0	4,9	5,0
80 mm	- 15,0	22,0	2,9	4,0
63 mm	- 15,0	22,0	0,9	3,0
50 mm	- 15,0	22,0	- 1,1	2,0
40 mm	- 15,0	22,0	- 3,2	1,0

Wavelength	$L_{r,VEHj}$			
	Min	Max	EN ISO 3095:2013 (Well maintained and very smooth)	Average network (Normally maintained smooth)
31,5 mm	- 15,0	22,0	- 5,0	0,0
25 mm	- 15,0	22,0	- 5,6	- 1,0
20 mm	- 15,0	22,0	- 6,2	- 2,0
16 mm	- 15,0	22,0	- 6,8	- 3,0
12 mm	- 15,0	22,0	- 7,4	- 4,0
10 mm	- 15,0	22,0	- 8,0	- 5,0
8 mm	- 15,0	22,0	- 8,6	- 6,0
6,3 mm	- 15,0	22,0	- 9,2	- 7,0
5 mm	- 15,0	22,0	- 9,8	- 8,0
4 mm	- 15,0	22,0	- 10,4	- 9,0
3,2 mm	- 15,0	22,0	- 11,0	- 10,0
2,5 mm	- 15,0	22,0	- 11,6	- 11,0
2 mm	- 15,0	22,0	- 12,2	- 12,0
1,6 mm	- 15,0	22,0	- 12,8	- 13,0
1,2 mm	- 15,0	22,0	- 13,4	- 14,0
1 mm	- 15,0	22,0	- 14,0	- 15,0
0,8 mm	- 15,0	22,0	- 14,0	- 15,0

Table G-2

Coefficients $A_{3,i}$ for the contact filter

Wavelength	$A_{3,i}$						
	Min	Max	Axle load 50 kN — wheel diameter 360 mm	Axle load 50 kN — wheel diameter 680 mm	Axle load 25 kN — wheel diameter 920 mm	Axle load 50 kN — wheel diameter 920 mm	Axle load 100 kN — wheel diameter 920 mm
1 000 mm	- 30,0	0,0	0,0	0,0	0,0	0,0	0,0
800 mm	- 30,0	0,0	0,0	0,0	0,0	0,0	0,0
630 mm	- 30,0	0,0	0,0	0,0	0,0	0,0	0,0
500 mm	- 30,0	0,0	0,0	0,0	0,0	0,0	0,0
400 mm	- 30,0	0,0	0,0	0,0	0,0	0,0	0,0

Wavelength	A_{3j}						
	Min	Max	Axle load 50 kN — wheel diameter 360 mm	Axle load 50 kN — wheel diameter 680 mm	Axle load 25 kN — wheel diameter 920 mm	Axle load 50 kN — wheel diameter 920 mm	Axle load 100 kN — wheel diameter 920 mm
315 mm	- 30,0	0,0	0,0	0,0	0,0	0,0	0,0
250 mm	- 30,0	0,0	0,0	0,0	0,0	0,0	0,0
200 mm	- 30,0	0,0	0,0	0,0	0,0	0,0	0,0
160 mm	- 30,0	0,0	0,0	0,0	0,0	0,0	0,0
120 mm	- 30,0	0,0	0,0	0,0	0,0	0,0	0,0
100 mm	- 30,0	0,0	0,0	0,0	0,0	0,0	0,0
80 mm	- 30,0	0,0	0,0	0,0	0,0	- 0,2	- 0,2
63 mm	- 30,0	0,0	0,0	- 0,2	- 0,2	- 0,5	- 0,6
50 mm	- 30,0	0,0	- 0,2	- 0,4	- 0,5	- 0,9	- 1,3
40 mm	- 30,0	0,0	- 0,5	- 0,7	- 0,9	- 1,6	- 2,2
31,5 mm	- 30,0	0,0	- 1,2	- 1,5	- 1,6	- 2,5	- 3,7
25 mm	- 30,0	0,0	- 2,0	- 2,8	- 2,5	- 3,8	- 5,8
20 mm	- 30,0	0,0	- 3,0	- 4,5	- 3,8	- 5,8	- 9,0
16 mm	- 30,0	0,0	- 4,3	- 7,0	- 5,8	- 8,5	- 11,5
12 mm	- 30,0	0,0	- 6,0	- 10,3	- 8,5	- 11,4	- 12,5
10 mm	- 30,0	0,0	- 8,4	- 12,0	- 12,0	- 12,0	- 12,0
8 mm	- 30,0	0,0	- 12,0	- 12,5	- 12,6	- 13,5	- 14,0
6,3 mm	- 30,0	0,0	- 11,5	- 13,5	- 13,5	- 14,5	- 15,0
5 mm	- 30,0	0,0	- 12,5	- 16,0	- 14,5	- 16,0	- 17,0
4 mm	- 30,0	0,0	- 13,9	- 16,0	- 16,0	- 16,5	- 18,4
3,2 mm	- 30,0	0,0	- 14,7	- 16,5	- 16,5	- 17,7	- 19,5
2,5 mm	- 30,0	0,0	- 15,6	- 17,0	- 17,7	- 18,6	- 20,5
2 mm	- 30,0	0,0	- 16,6	- 18,0	- 18,6	- 19,6	- 21,5
1,6 mm	- 30,0	0,0	- 17,6	- 19,0	- 19,6	- 20,6	- 22,4
1,2 mm	- 30,0	0,0	- 18,6	- 20,2	- 20,6	- 21,6	- 23,5
1 mm	- 30,0	0,0	- 19,6	- 21,2	- 21,6	- 22,6	- 24,5
0,8 mm	- 30,0	0,0	- 20,6	- 22,2	- 22,6	- 23,6	- 25,4

Table G-3

Coefficients $L_{H,TR,i}$, $L_{H,VEH,i}$ and $L_{H,VEH,SUP}$ for transfer functions

(Values are expressed in Sound Power Level per axle)

Frequency	$L_{H,TR,i}$								
	Min	Max	Mono-block sleeper on soft rail pad	Mono-block sleeper on medium stiffness rail pad	Mono-block on hard rail pad	Bi-block sleeper on soft rail pad	Bi-block sleeper on medium stiffness rail pad	Bi-block sleeper on hard rail pad	Wooden sleepers
50 Hz	0,0	140,0	53,3	50,9	50,1	50,9	50,0	49,8	44,0
63 Hz	0,0	140,0	59,3	57,8	57,2	56,6	56,1	55,9	51,0
80 Hz	0,0	140,0	67,2	66,5	66,3	64,3	64,1	64,0	59,9
100 Hz	0,0	140,0	75,9	76,8	77,2	72,3	72,5	72,5	70,8
125 Hz	0,0	140,0	79,2	80,9	81,6	75,4	75,8	75,9	75,1
160 Hz	0,0	140,0	81,8	83,3	84,0	78,5	79,1	79,4	76,9
200 Hz	0,0	140,0	84,2	85,8	86,5	81,8	83,6	84,4	77,2
250 Hz	0,0	140,0	88,6	90,0	90,7	86,6	88,7	89,7	80,9
316 Hz	0,0	140,0	91,0	91,6	92,1	89,1	89,6	90,2	85,3
400 Hz	0,0	140,0	94,5	93,9	94,3	91,9	89,7	90,2	92,5
500 Hz	0,0	140,0	97,0	95,6	95,8	94,5	90,6	90,8	97,0
630 Hz	0,0	140,0	99,2	97,4	97,0	97,5	93,8	93,1	98,7
800 Hz	0,0	140,0	104,0	101,7	100,3	104,0	100,6	97,9	102,8
1 000 Hz	0,0	140,0	107,1	104,4	102,5	107,9	104,7	101,1	105,4
1 250 Hz	0,0	140,0	108,3	106,0	104,2	108,9	106,3	103,4	106,5
1 600 Hz	0,0	140,0	108,5	106,8	105,4	108,8	107,1	105,4	106,4
2 000 Hz	0,0	140,0	109,7	108,3	107,1	109,8	108,8	107,7	107,5
2 500 Hz	0,0	140,0	110,0	108,9	107,9	110,2	109,3	108,5	108,1
3 160 Hz	0,0	140,0	110,0	109,1	108,2	110,1	109,4	108,7	108,4
4 000 Hz	0,0	140,0	110,0	109,4	108,7	110,1	109,7	109,1	108,7
5 000 Hz	0,0	140,0	110,3	109,9	109,4	110,3	110,0	109,6	109,1
6 350 Hz	0,0	140,0	110,0	109,9	109,7	109,9	109,8	109,6	109,1

Frequency	$L_{H,TR,i}$								
	Min	Max	Mono-block sleeper on soft rail pad	Mono-block sleeper on medium stiffness rail pad	Mono-block on hard rail pad	Bi-block sleeper on soft rail pad	Bi-block sleeper on medium stiffness rail pad	Bi-block sleeper on hard rail pad	Wooden sleepers
8 000 Hz	0,0	140,0	110,1	110,3	110,4	110,0	110,0	109,9	109,5
10 000 Hz	0,0	140,0	110,6	111,0	111,4	110,4	110,5	110,6	110,2

Frequency	$L_{H,VEH,i}$					
	Min	Max	Wheel with diameter 920 mm, no measure	Wheel with diameter 840 mm, no measure	Wheel with diameter 680 mm, no measure	Wheel with diameter 1 200 mm, no measure
50 Hz	60,0	140,0	75,4	75,4	75,4	75,4
63 Hz	60,0	140,0	77,3	77,3	77,3	77,3
80 Hz	60,0	140,0	81,1	81,1	81,1	81,1
100 Hz	60,0	140,0	84,1	84,1	84,1	84,1
125 Hz	60,0	140,0	83,3	82,8	82,8	82,8
160 Hz	60,0	140,0	84,3	83,3	83,3	83,3
200 Hz	60,0	140,0	86,0	84,1	83,9	84,5
250 Hz	60,0	140,0	90,1	86,9	86,3	90,4
316 Hz	60,0	140,0	89,8	87,9	88,0	90,4
400 Hz	60,0	140,0	89,0	89,9	92,2	89,9
500 Hz	60,0	140,0	88,8	90,9	93,9	90,1
630 Hz	60,0	140,0	90,4	91,5	92,5	91,3
800 Hz	60,0	140,0	92,4	91,5	90,9	91,5
1 000 Hz	60,0	140,0	94,9	93,0	90,4	93,6
1 250 Hz	60,0	140,0	100,4	98,7	93,2	100,5
1 600 Hz	60,0	140,0	104,6	101,6	93,5	104,6
2 000 Hz	60,0	140,0	109,6	107,6	99,6	115,6
2 500 Hz	60,0	140,0	114,9	111,9	104,9	115,9
3 160 Hz	60,0	140,0	115,0	114,5	108,0	116,0

Frequency	$L_{H,VEHj}$					
	Min	Max	Wheel with diameter 920 mm, no measure	Wheel with diameter 840 mm, no measure	Wheel with diameter 680 mm, no measure	Wheel with diameter 1 200 mm, no measure
4 000 Hz	60,0	140,0	115,0	114,5	111,0	116,0
5 000 Hz	60,0	140,0	115,5	115,0	111,5	116,5
6 350 Hz	60,0	140,0	115,6	115,1	111,6	116,6
8 000 Hz	60,0	140,0	116,0	115,5	112,0	117,0
10 000 Hz	60,0	140,0	116,7	116,2	112,7	117,7

Frequency	$L_{H,VEH,SUPi}$		
	Min	Max	EU standard
50 Hz	0,0	140,0	0,0
63 Hz	0,0	140,0	0,0
80 Hz	0,0	140,0	0,0
100 Hz	0,0	140,0	0,0
125 Hz	0,0	140,0	0,0
160 Hz	0,0	140,0	0,0
200 Hz	0,0	140,0	0,0
250 Hz	0,0	140,0	0,0
316 Hz	0,0	140,0	0,0
400 Hz	0,0	140,0	0,0
500 Hz	0,0	140,0	0,0
630 Hz	0,0	140,0	0,0
800 Hz	0,0	140,0	0,0
1 000 Hz	0,0	140,0	0,0
1 250 Hz	0,0	140,0	0,0
1 600 Hz	0,0	140,0	0,0
2 000 Hz	0,0	140,0	0,0
2 500 Hz	0,0	140,0	0,0
3 160 Hz	0,0	140,0	0,0
4 000 Hz	0,0	140,0	0,0

Frequency	$L_{H,VEH,SUP,i}$		
	Min	Max	EU standard
5 000 Hz	0,0	140,0	0,0
6 350 Hz	0,0	140,0	0,0
8 000 Hz	0,0	140,0	0,0
10 000 Hz	0,0	140,0	0,0

Table G-4

Coefficients $L_{R,IMPACT,i}$ for impact noise

Wavelength	$L_{R,IMPACT,i}$		
	Min	Max	Single switch/joint/crossing/ 100 m
1 000 mm	- 40	30	22,4
800 mm	- 40	30	22,4
630 mm	- 40	30	22,4
500 mm	- 40	30	23,8
400 mm	- 40	30	24,7
315 mm	- 40	30	24,7
250 mm	- 40	30	23,4
200 mm	- 40	30	21,7
160 mm	- 40	30	20,2
120 mm	- 40	30	20,4
100 mm	- 40	30	20,8
80 mm	- 40	30	20,9
63 mm	- 40	30	19,8
50 mm	- 40	30	18
40 mm	- 40	30	16
31,5 mm	- 40	30	13
25 mm	- 40	30	10
20 mm	- 40	30	6
16 mm	- 40	30	1
12 mm	- 40	30	- 4

Wavelength	$L_{R,IMPACTi}$		
	Min	Max	Single switch/joint/crossing/ 100 m
10 mm	- 40	30	- 11
8 mm	- 40	30	- 16,5
6,3 mm	- 40	30	- 18,5
5 mm	- 40	30	- 21
4 mm	- 40	30	- 22,5
3,2 mm	- 40	30	- 24,7
2,5 mm	- 40	30	- 26,6
2 mm	- 40	30	- 28,6
1,6 mm	- 40	30	- 30,6
1,2 mm	- 40	30	- 32,6
1 mm	- 40	30	- 34
0,8 mm	- 40	30	- 34

Table G-5

Coefficients $L_{w,0,idling}$ for traction noise

(Values are expressed in Sound Power Level per vehicle)

Frequency	$L_{w,0,idling}$													
	Min		Max		Diesel locomotive (c. 800 kW)		Diesel locomotive (c. 2 200 kW)		Diesel multiple unit		Electric locomotive		Electric multiple unit	
	SourceA	SourceB	SourceA	SourceB	SourceA	SourceB	SourceA	SourceB	SourceA	SourceB	SourceA	SourceB	SourceA	SourceB
50 Hz	0,0	0,0	140,0	140,0	98,9	103,2	99,4	103,7	82,6	86,9	87,9	92,2	80,5	84,8
63 Hz	0,0	0,0	140,0	140,0	94,8	100,0	107,3	112,5	82,5	87,7	90,8	96,0	81,4	86,6
80 Hz	0,0	0,0	140,0	140,0	92,6	95,5	103,1	106,0	89,3	92,2	91,6	94,5	80,5	83,4
100 Hz	0,0	0,0	140,0	140,0	94,6	94,0	102,1	101,5	90,3	89,7	94,6	94,0	82,2	81,6
125 Hz	0,0	0,0	140,0	140,0	92,8	93,3	99,3	99,8	93,5	94,0	94,8	95,3	80,0	80,5
160 Hz	0,0	0,0	140,0	140,0	92,8	93,6	99,3	100,1	99,5	100,3	96,8	97,6	79,7	80,5
200 Hz	0,0	0,0	140,0	140,0	93,0	92,9	99,5	99,4	98,7	98,6	104,0	103,9	79,6	79,5
250 Hz	0,0	0,0	140,0	140,0	94,8	92,7	101,3	99,2	95,5	93,4	100,8	98,7	96,4	94,3
316 Hz	0,0	0,0	140,0	140,0	94,6	92,4	101,1	98,9	90,3	88,1	99,6	97,4	80,5	78,3
400 Hz	0,0	0,0	140,0	140,0	95,7	92,8	102,2	99,3	91,4	88,5	101,7	98,8	81,3	78,4
500 Hz	0,0	0,0	140,0	140,0	95,6	92,8	102,1	99,3	91,3	88,5	98,6	95,8	97,2	94,4
630 Hz	0,0	0,0	140,0	140,0	98,6	96,8	101,1	99,3	90,3	88,5	95,6	93,8	79,5	77,7

Frequency	$L_{W,0,dlling}$													
	Min		Max		Diesel locomotive (c. 800 kW)		Diesel locomotive (c. 2 200 kW)		Diesel multiple unit		Electric locomotive		Electric multiple unit	
	SourceA	SourceB	SourceA	SourceB	SourceA	SourceB	SourceA	SourceB	SourceA	SourceB	SourceA	SourceB	SourceA	SourceB
800 Hz	0,0	0,0	140,0	140,0	95,2	92,7	101,7	99,2	90,9	88,4	95,2	92,7	79,8	77,3
1 000 Hz	0,0	0,0	140,0	140,0	95,1	93,0	101,6	99,5	91,8	89,7	96,1	94,0	86,7	84,6
1 250 Hz	0,0	0,0	140,0	140,0	95,1	92,9	99,3	97,1	92,8	90,6	92,1	89,9	81,7	79,5
1 600 Hz	0,0	0,0	140,0	140,0	94,1	93,1	96,0	95,0	92,8	91,8	89,1	88,1	82,7	81,7
2 000 Hz	0,0	0,0	140,0	140,0	94,1	93,2	93,7	92,8	90,8	89,9	87,1	86,2	80,7	79,8
2 500 Hz	0,0	0,0	140,0	140,0	99,4	98,3	101,9	100,8	88,1	87,0	85,4	84,3	78,0	76,9
3 160 Hz	0,0	0,0	140,0	140,0	92,5	91,5	89,5	88,5	85,2	84,2	83,5	82,5	75,1	74,1
4 000 Hz	0,0	0,0	140,0	140,0	89,5	88,7	87,1	86,3	83,2	82,4	81,5	80,7	72,1	71,3
5 000 Hz	0,0	0,0	140,0	140,0	87,0	86,0	90,5	89,5	81,7	80,7	80,0	79,0	69,6	68,6
6 350 Hz	0,0	0,0	140,0	140,0	84,1	83,4	31,4	30,7	78,8	78,1	78,1	77,4	66,7	66,0
8 000 Hz	0,0	0,0	140,0	140,0	81,5	80,9	81,2	80,6	76,2	75,6	76,5	75,9	64,1	63,5
10 000 Hz	0,0	0,0	140,0	140,0	79,2	78,7	79,6	79,1	73,9	73,4	75,2	74,7	61,8	61,3

Table G-6

Coefficients $L_{W,0,1}$, $L_{W,0,2}$, α_1 , α_2 for aerodynamic noise

(Values are expressed in Sound Power Level per vehicle (for a vehicle length of 20 m))

Frequency	Min		Max		Aerodynamic noise given at 300 km/h	
	α_1	α_2	α_1	α_2	α_1	α_2
	0	0	100	100	50	50
	$L_{W,0,1}$	$L_{W,0,2}$	$L_{W,0,1}$	$L_{W,0,2}$	$L_{W,0,1}$	$L_{W,0,2}$
50 Hz	0	0	140	140	112,6	36,7
63 Hz	0	0	140	140	113,2	38,5
80 Hz	0	0	140	140	115,7	39,0
100 Hz	0	0	140	140	117,4	37,5
125 Hz	0	0	140	140	115,3	36,8
160 Hz	0	0	140	140	115,0	37,1
200 Hz	0	0	140	140	114,9	36,4
250 Hz	0	0	140	140	116,4	36,2
316 Hz	0	0	140	140	115,9	35,9
400 Hz	0	0	140	140	116,3	36,3

Frequency	Min		Max		Aerodynamic noise given at 300 km/h	
	α_1	α_2	α_1	α_2	α_1	α_2
	0	0	100	100	50	50
	$L_{W,0,1}$	$L_{W,0,2}$	$L_{W,0,1}$	$L_{W,0,2}$	$L_{W,0,1}$	$L_{W,0,2}$
500 Hz	0	0	140	140	116,2	36,3
630 Hz	0	0	140	140	115,2	36,3
800 Hz	0	0	140	140	115,8	36,2
1 000 Hz	0	0	140	140	115,7	36,5
1 250 Hz	0	0	140	140	115,7	36,4
1 600 Hz	0	0	140	140	114,7	105,2
2 000 Hz	0	0	140	140	114,7	110,3
2 500 Hz	0	0	140	140	115,0	110,4
3 160 Hz	0	0	140	140	114,5	105,6
4 000 Hz	0	0	140	140	113,1	37,2
5 000 Hz	0	0	140	140	112,1	37,5
6 350 Hz	0	0	140	140	110,6	37,9
8 000 Hz	0	0	140	140	109,6	38,4
10 000 Hz	0	0	140	140	108,8	39,2

Table G-7

Coefficients C_{bridge} for structural radiation

C_{bridge}			
min	max	Predominantly concrete or masonry bridges with any trackform	Predominantly steel bridges with ballasted track
0	9	1	4

Appendix H

Database for industrial source

This appendix presents a few examples for input values for some industrial noise sources that may be used to calculate industrial noise following the method described in 2.4 Industrial noise. As industrial noise sources are extremely specific for each industrial site, appropriate values are obtained from local, national or international databases or measurements as appropriate.

Table H-1

Coefficients L_w , L_w' and $\Delta L_{w,dir,xyz}(x, y, z)$ for sound power

$$\Delta L_{w,dir,xyz}(x, y, z)=0$$

L_w is expressed as sound power per metre for line source, or per squared metre for area source.

Description	Type of source	Source directivity	63	125	250	500	1 000	2 000	4 000	8 000
Grit blasting — outside — with nozzle	PointSource	FreeField	108,77	110,37	112,77	107,77	104,37	98,07	97,07	86,97
Rotary kiln	LineSource	FreeField	79,27	84,17	86,67	89,27	93,07	93,47	92,07	87,77
Ship yard	AreaSource	HemiSpherical	67,17	69,07	74,57	62,17	63,97	66,77	70,97	68,07
Gas terminal	AreaSource	HemiSpherical	74,17	70,07	65,57	64,17	59,97	57,77	51,97	56,07

Appendix I

Database for aircraft source — NPD data

This appendix presents the database for most of the existing aircraft noise sources to be used to calculate aircraft noise following the method described in 2.6 Aircraft noise.

Table I-1

Aerodynamic coefficients

ACFT_ID	OP_TYPE	FLAP_ID	B (ft/lb)	C (kt/ $\sqrt{\text{lb}}$)	D (kt/ $\sqrt{\text{lb}}$)	R
1900D	A	35-A			0,915858	0,130495
1900D	A	A_40D			0,416345	0,140491
1900D	A	ZERO-A				0,106643
1900D	D	17-D	0,060076	0,858496		0,072968
1900D	D	ZERO-D				0,094383
707320	A	D-25			0,307537	0,107756
707320	A	D-40			0,279116	0,134567
707320	A	D-50			0,275511	0,15472
707320	A	U-25				0,098219
707320	D	14	0,004514	0,312431		0,089316
707320	D	INT				0,072743
707320	D	ZERO				0,05617
707QN	A	D-25			0,307537	0,107756
707QN	A	D-40			0,279116	0,134567
707QN	A	D-50			0,275511	0,15472
707QN	A	U-25				0,098219
707QN	D	14	0,004514	0,312431		0,089316
707QN	D	INT				0,072743
707QN	D	ZERO				0,05617
717200	A	A_0U				0,06456
717200	A	A_13D				0,109249
717200	A	A_13U				0,095353
717200	A	A_18D				0,11009
717200	A	A_18U				0,095015
717200	A	A_40D			0,416345	0,140491
717200	D	T_00B				0,06

ACFT_ID	OP_TYPE	FLAP_ID	B (ft/lb)	C (kt/√lb)	D (kt/√lb)	R
717200	D	T_00C				0,06
717200	D	T_05H	0,011607	0,483254		0,075
717200	D	T_05M	0,011795	0,489068		0,075
717200	D	T_13A	0,010862	0,469923		0,078
720B	A	D-30			0,350247	0,109478
720B	A	D-50			0,339412	0,148843
720B	A	U-30				0,09805
720B	D	20	0,00573	0,356426		0,091933
720B	D	30	0,005238	0,340735		0,104243
720B	D	INT				0,074052
720B	D	ZERO				0,05617
727100	A	D-25			0,350485	0,128359
727100	A	D-30			0,343897	0,145903
727100	A	D-40			0,335992	0,186604
727100	A	U-15				0,090698
727100	A	U-25				0,113154
727100	D	2				0,0857
727100	D	5	0,008692	0,415048		0,088916
727100	D	15	0,008301	0,392649		0,095459
727100	D	25	0,007389	0,371567		0,115623
727100	D	ZERO				0,0636
727D15	A	D-25			0,383689	0,109535
727D15	A	D-30			0,368	0,1437
727D15	A	D-40			0,36	0,1844
727D15	A	U-15				0,089969
727D15	A	U-25				0,109535
727D15	D	2				0,0857
727D15	D	5	0,00924	0,409		0,0869
727D15	D	15	0,00826	0,388		0,0929
727D15	D	20	0,007712	0,376653		0,108897
727D15	D	25	0,00763	0,367		0,1112
727D15	D	ZERO				0,0594
727D17	A	D-25			0,383689	0,124821

ACFT_ID	OP_TYPE	FLAP_ID	B (ft/lb)	C (kt/√lb)	D (kt/√lb)	R
727D17	A	D-30			0,368	0,1437
727D17	A	D-40			0,36	0,1844
727D17	A	U-15				0,089969
727D17	A	U-25				0,109535
727D17	D	2				0,0857
727D17	D	5	0,00924	0,409		0,0869
727D17	D	15	0,00826	0,388		0,0929
727D17	D	20	0,007712	0,376653		0,108897
727D17	D	25	0,00763	0,367		0,1112
727D17	D	ZERO				0,0594
727EM1	A	D-25			0,350485	0,128359
727EM1	A	D-30			0,343897	0,145903
727EM1	A	D-40			0,335992	0,186604
727EM1	A	U-15				0,090698
727EM1	A	U-25				0,113154
727EM1	D	2				0,0857
727EM1	D	5	0,008692	0,415048		0,088916
727EM1	D	15	0,008301	0,392649		0,095459
727EM1	D	25	0,007389	0,371567		0,115623
727EM1	D	ZERO				0,0636
727EM2	A	D-25			0,383689	0,109535
727EM2	A	D-30			0,368	0,1437
727EM2	A	D-40			0,36	0,1844
727EM2	A	U-15				0,089969
727EM2	A	U-25				0,109535
727EM2	D	2				0,0857
727EM2	D	5	0,00924	0,409		0,0869
727EM2	D	15	0,00826	0,388		0,0929
727EM2	D	20	0,007712	0,376653		0,108897
727EM2	D	25	0,00763	0,367		0,1112
727EM2	D	ZERO				0,0594
727Q15	A	D-25			0,383689	0,109535
727Q15	A	D-30			0,368	0,1437

ACFT_ID	OP_TYPE	FLAP_ID	B (ft/lb)	C (kt/ $\sqrt{\text{lb}}$)	D (kt/ $\sqrt{\text{lb}}$)	R
727Q15	A	D-40			0,36	0,1844
727Q15	A	U-15				0,089969
727Q15	A	U-25				0,109535
727Q15	D	2				0,0857
727Q15	D	5	0,00924	0,409		0,0869
727Q15	D	15	0,00826	0,388		0,0929
727Q15	D	20	0,007712	0,376653		0,108897
727Q15	D	25	0,00763	0,367		0,1112
727Q15	D	ZERO				0,0594
727Q7	A	D-25			0,350485	0,128359
727Q7	A	D-30			0,343897	0,145903
727Q7	A	D-40			0,335992	0,186604
727Q7	A	U-15				0,090698
727Q7	A	U-25				0,113154
727Q7	D	2				0,0857
727Q7	D	5	0,008692	0,415048		0,088916
727Q7	D	15	0,008301	0,392649		0,095459
727Q7	D	25	0,007389	0,371567		0,115623
727Q7	D	ZERO				0,0636
727Q9	A	D-25			0,372885	0,124565
727Q9	A	D-30			0,367614	0,142606
727Q9	A	D-40			0,359182	0,184273
727Q9	A	U-15				0,090523
727Q9	A	U-25				0,109315
727Q9	D	2				0,0857
727Q9	D	5	0,00924	0,409		0,0869
727Q9	D	15	0,00826	0,388		0,0929
727Q9	D	20	0,007712	0,376653		0,108897
727Q9	D	25	0,00763	0,367		0,1112
727Q9	D	ZERO				0,0594
727QF	A	D-15				0,1182
727QF	A	D-25				0,1359
727QF	A	D-30			0,3658	0,1602

ACFT_ID	OP_TYPE	FLAP_ID	B (ft/lb)	C (kt/ $\sqrt{\text{lb}}$)	D (kt/ $\sqrt{\text{lb}}$)	R
727QF	A	D-40			0,3568	0,2003
727QF	A	U-05				0,08709
727QF	A	U-15				0,09676
727QF	A	U-25				0,1201
727QF	A	U-ZERO				0,06027
727QF	D	2				0,081
727QF	D	5	0,00849	0,4242		0,0921
727QF	D	15	0,007525	0,412		0,1005
727QF	D	25	0,0069	0,3885		0,1222
727QF	D	ZERO				0,06599
737	A	D-25			0,452885	0,113106
737	A	D-30			0,442783	0,124898
737	A	D-40			0,432682	0,155057
737	A	U-15				0,088617
737	A	U-25				0,097687
737	D	5	0,011593	0,475473		0,085235
737	D	10	0,010935	0,457438		0,093192
737	D	25	0,010293	0,436124		0,109993
737	D	INT				0,07477
737	D	ZERO				0,0643
737300	A	D-15			0,4639	0,1103
737300	A	D-30			0,434	0,1247
737300	A	D-40			0,4215	0,1471
737300	D	1	0,0126	0,4958		0,069
737300	D	5	0,0116	0,477215		0,0742
737300	D	15	0,0111	0,4572		0,0872
737300	D	ZERO				0,062
7373B2	A	D-15			0,4639	0,1103
7373B2	A	D-30			0,434	0,1247
7373B2	A	D-40			0,4215	0,1471
7373B2	D	1	0,0124	0,4958		0,0761
7373B2	D	5	0,011511	0,477758		0,0794
7373B2	D	15	0,011	0,4575		0,0872
7373B2	D	T_01				0,067

ACFT_ID	OP_TYPE	FLAP_ID	B (ft/lb)	C (kt/ $\sqrt{\text{lb}}$)	D (kt/ $\sqrt{\text{lb}}$)	R
7373B2	D	T_05				0,074679
7373B2	D	ZERO				0,062
737400	A	D-15			0,4779	0,1079
737400	A	D-30			0,4338	0,1251
737400	A	D-40			0,423	0,151
737400	D	1				0,0713
737400	D	5	0,0117	0,4834		0,0798
737400	D	15	0,0109	0,4596		0,0924
737400	D	ZERO				0,0628
737500	A	D-15			0,4538	0,1084
737500	A	D-30			0,4281	0,1253
737500	A	D-40			0,4166	0,151
737500	D	1				0,0712
737500	D	5	0,01138	0,474697		0,0803
737500	D	15	0,0109	0,4541		0,0925
737500	D	ZERO				0,061
737700	A	A_15			0,4122	0,1048
737700	A	A_30			0,3986	0,1194
737700	A	A_40			0,3907	0,1434
737700	D	T_00H				0,063
737700	D	T_01	0,0097	0,4329		0,062
737700	D	T_05A				0,07
737700	D	T_10	0,0089	0,4112		0,0858
737700	D	T_15	0,0087	0,406		0,0889
737700	D	T_25	0,0086	0,4021		0,0932
737700	D	T_5	0,0093	0,4251		0,0749
737700	D	T_ZERO				0,0552
737800	D	T_00				0,05625
737800	D	T_01				0,06253
737800	D	T_05	0,009633	0,435043		0,0737
737D17	A	D-25			0,451848	0,113169
737D17	A	D-30			0,443779	0,125252

ACFT_ID	OP_TYPE	FLAP_ID	B (ft/lb)	C (kt/ $\sqrt{\text{lb}}$)	D (kt/ $\sqrt{\text{lb}}$)	R
737D17	A	D-40			0,434096	0,156502
737D17	A	U-15				0,106085
737D17	A	U-25				0,097127
737D17	D	5	0,011677	0,473007		0,087424
737D17	D	10	0,010956	0,456114		0,096364
737D17	D	25	0,010406	0,436124		0,10878
737D17	D	INT				0,07586
737D17	D	ZERO				0,0643
737N17	A	D-25			0,451848	0,113169
737N17	A	D-30			0,443779	0,125252
737N17	A	D-40			0,434096	0,156502
737N17	A	U-15				0,106085
737N17	A	U-25				0,097127
737N17	D	5	0,011677	0,473007		0,087424
737N17	D	10	0,010956	0,456114		0,096364
737N17	D	25	0,010406	0,436124		0,10878
737N17	D	INT				0,07586
737N17	D	ZERO				0,0643
737N9	A	D-25			0,452885	0,113106
737N9	A	D-30			0,442783	0,124898
737N9	A	D-40			0,432682	0,155057
737N9	A	U-15				0,088617
737N9	A	U-25				0,097687
737N9	D	5	0,011593	0,475473		0,085235
737N9	D	10	0,010935	0,457438		0,093192
737N9	D	25	0,010293	0,436124		0,109993
737N9	D	INT				0,07477
737N9	D	ZERO				0,0643
737QN	A	D-25			0,452885	0,113106
737QN	A	D-30			0,442783	0,124898
737QN	A	D-40			0,432682	0,155057
737QN	A	U-15				0,088617
737QN	A	U-25				0,097687

ACFT_ID	OP_TYPE	FLAP_ID	B (ft/lb)	C (kt/√lb)	D (kt/√lb)	R
737QN	D	5	0,011593	0,475473		0,085235
737QN	D	10	0,010935	0,457438		0,093192
737QN	D	25	0,010293	0,436124		0,109993
737QN	D	INT				0,07477
737QN	D	ZERO				0,0643
74710Q	A	D-20			0,217555	0,109467
74710Q	A	D-25			0,210537	0,116953
74710Q	A	D-30			0,202116	0,142564
74710Q	A	U-20				0,091737
74710Q	D	5				0,07456
74710Q	D	10	0,002333	0,212212		0,092196
74710Q	D	20	0,002187	0,202456		0,099504
74710Q	D	ZERO				0,05693
747200	A	D-20			0,217555	0,109467
747200	A	D-25			0,210537	0,116953
747200	A	D-30			0,202116	0,142564
747200	A	U-20				0,091737
747200	D	5				0,074042
747200	D	10	0,00235	0,211659		0,091154
747200	D	20	0,002207	0,203133		0,098616
747200	D	ZERO				0,05693
74720A	A	D-25			0,2105	0,118
74720A	A	D-30			0,2017	0,1438
74720A	D	5				0,0722
74720A	D	10	0,00234	0,2115		0,08917
74720A	D	20	0,002186	0,2029		0,09728
74720A	D	ZERO				0,05524
74720B	A	D-25			0,2113	0,1207
74720B	A	D-30			0,2016	0,1444
74720B	D	5				0,07276
74720B	D	10	0,002351	0,213		0,0886
74720B	D	20	0,002196	0,2045		0,09867
74720B	D	ZERO				0,05693

ACFT_ID	OP_TYPE	FLAP_ID	B (ft/lb)	C (kt/ \sqrt{lb})	D (kt/ \sqrt{lb})	R
747400	A	D-25			0,2143	0,1171
747400	A	D-30			0,2064	0,141
747400	D	5				0,069
747400	D	10	0,002104	0,21338		0,0823
747400	D	20	0,0021	0,2062		0,0916
747400	D	T_00H				0,053
747400	D	T_01				0,057691
747400	D	T_05				0,071
747400	D	T_05C				0,057569
747400	D	T_10	0,002101	0,207131		0,110782
747400	D	T_10H				0,1
747400	D	ZERO		0,3111		0,0508
7478	A	F_20			0,192660	0,128462
7478	A	F_30			0,189605	0,143406
7478	D	F_0				0,052717
7478	D	F_1				0,064841
7478	D	F_10	0,002000	0,204760		0,083321
7478	D	F_5				0,073443
747SP	A	D-20			0,216415	0,110347
747SP	A	D-25			0,209991	0,116897
747SP	A	D-30			0,202497	0,143096
747SP	A	U-20				0,092569
747SP	D	5				0,076123
747SP	D	10	0,002357	0,210572		0,095316
747SP	D	20	0,002179	0,201901		0,103296
747SP	D	ZERO				0,05693
757300	D	T_00				0,05554
757300	D	T_01				0,05943
757300	D	T_05	0,006931	0,38754		0,07993
757PW	A	D-25			0,3234	0,1186
757PW	A	D-30			0,3179	0,1342
757PW	D	5	0,006243	0,360271		0,0722
757PW	D	15	0,00611	0,3454		0,0782

ACFT_ID	OP_TYPE	FLAP_ID	B (ft/lb)	C (kt/ \sqrt{lb})	D (kt/ \sqrt{lb})	R
757PW	D	20	0,00573	0,33		0,0864
757PW	D	T_00				0,055346
757PW	D	T_01				0,0609
757PW	D	T_05		0,360271		0,0682
757PW	D	ZERO		0,4699		0,0548
757RR	A	D-25			0,3238	0,1178
757RR	A	D-30			0,3191	0,1337
757RR	D	5	0,006319	0,36165		0,07
757RR	D	15	0,00614	0,3454		0,0758
757RR	D	20	0,0057	0,33		0,0847
757RR	D	INT				0,0621
757RR	D	T_00				0,0525
757RR	D	T_01				0,058316
757RR	D	T_05				0,0635
757RR	D	ZERO		0,4699		0,0541
767300	A	D-25			0,2627	0,121
767300	A	D-30			0,2555	0,1329
767300	D	5	0,00409	0,297		0,075
767300	D	15	0,00381	0,2853		0,0824
767300	D	20	0,00367	0,2788		0,0866
767300	D	INT				0,0641
767300	D	ZERO				0,0531
767400	A	L_25_D			0,2601	0,1156
767400	A	L_30_D			0,2536	0,1265
767400	D	T_00_U				0,0492
767400	D	T_05_U	0,0043	0,2972		0,0674
767400	D	T_05A				0,055
767400	D	T_05B				0,06
767400	D	T_15_U	0,0041	0,2876		0,0736
767400	D	T_20_U	0,003624	0,2775		0,0794
767CF6	A	D-25			0,29009	0,1075
767CF6	A	D-30			0,28096	0,1232
767CF6	D	1	0,00557	0,31625		0,0646

ACFT_ID	OP_TYPE	FLAP_ID	B (ft/lb)	C (kt/√lb)	D (kt/√lb)	R
767CF6	D	5	0,0053	0,30576		0,0685
767CF6	D	15	0,00504	0,29249		0,074
767CF6	D	20	0,0049	0,28496		0,0779
767CF6	D	ZERO				0,0489
767JT9	A	D-25			0,29009	0,1085
767JT9	A	D-30			0,28096	0,1258
767JT9	D	1	0,00504	0,31625		0,0658
767JT9	D	5	0,00472	0,30576		0,0705
767JT9	D	15	0,00436	0,29249		0,0756
767JT9	D	20	0,00417	0,28496		0,0802
767JT9	D	ZERO				0,052
777200	A	D20			0,2204	0,09765
777200	A	D25			0,2133	0,1158
777200	A	D30			0,203	0,133
777200	D	15	0,002867	0,2299		0,07432
777200	D	20	0,002751	0,2239		0,08186
777200	D	T_00		0,3218		0,05065
777200	D	T_00H				0,052
777200	D	T_00L				0,048
777200	D	T_01		0,2921		0,05555
777200	D	T_01H				0,06
777200	D	T_05	0,002475	0,239429		0,06898
777200	D	T_05A				0,063456
777200	D	T_05C				0,092
777200	D	T_05CH				0,085
777300	A	L_25_D			0,2156	0,116
777300	A	L_30_D			0,2071	0,1322
777300	D	T_00_U				0,0504
777300	D	T_05_U	0,0031	0,2586		0,0645
777300	D	T_15_U	0,0028	0,2454		0,0704
777300	D	T_20_U	0,0027	0,2363		0,0783
7773ER	A	F_20			0,225340	0,104970
7773ER	A	F_30			0,209490	0,134910

ACFT_ID	OP_TYPE	FLAP_ID	B (ft/lb)	C (kt/ $\sqrt{\text{lb}}$)	D (kt/ $\sqrt{\text{lb}}$)	R
7773ER	D	FLAP_0				0,050171
7773ER	D	FLAP_1				0,054934
7773ER	D	FLAP_5	0,002710	0,240000		0,066100
7878R	A	F_00			0,393870	0,045060
7878R	A	F_01			0,329760	0,047700
7878R	A	F_05			0,288410	0,067150
7878R	A	FLAP20			0,260280	0,088050
7878R	A	FLAP30			0,246840	0,105000
7878R	D	FLAP_0				0,050055
7878R	D	FLAP_1				0,052026
7878R	D	FLAP_5	0,002949	0,256410		0,071636
A300-622R	A	1				0,071539
A300-622R	A	2_D				0,094763
A300-622R	A	2_U				0,072592
A300-622R	A	3_D			0,274926	0,102372
A300-622R	A	FULL_D			0,253296	0,125036
A300-622R	A	ZERO				0,052053
A300-622R	D	0				0,053127
A300-622R	D	1500	0,004121	0,292		0,072348
A300B4-203	A	D-15			0,28237	0,10607
A300B4-203	A	D-25			0,27151	0,125568
A300B4-203	D	1	0,005307	0,324359		0,090223
A300B4-203	D	8	0,004239	0,291059		0,093067
A300B4-203	D	15	0,00402	0,278999		0,102935
A300B4-203	D	ZERO				0,063491
A310-304	A	1				0,068197
A310-304	A	2_D				0,096731
A310-304	A	2_U				0,072778
A310-304	A	3_D			0,274926	0,106084
A310-304	A	FULL_D			0,253296	0,129438
A310-304	A	ZERO				0,054935
A310-304	D	0				0,055191
A310-304	D	1500	0,004875	0,313705		0,072016

ACFT_ID	OP_TYPE	FLAP_ID	B (ft/lb)	C (kt/ $\sqrt{\text{lb}}$)	D (kt/ $\sqrt{\text{lb}}$)	R
A319-131	A	1_A				0,06317
A319-131	A	2_D				0,098119
A319-131	A	2_U				0,071826
A319-131	A	3_D			0,379931	0,098121
A319-131	A	FULL_D			0,355927	0,124534
A319-131	A	ZERO_A				0,056446
A319-131	D	1				0,071598
A319-131	D	1+F	0,007077	0,376764		0,072635
A319-131	D	ZERO				0,05429
A320-211	A	1_A				0,061662
A320-211	A	2_D				0,096267
A320-211	A	2_U				0,067463
A320-211	A	3_D			0,385223	0,101204
A320-211	A	FULL_D			0,37052	0,11586
A320-211	A	ZERO_A				0,057558
A320-211	D	1				0,066827
A320-211	D	1+F	0,007701	0,394884		0,071403
A320-211	D	ZERO				0,056281
A320-232	A	1_A				0,059086
A320-232	A	2_D				0,095899
A320-232	A	2_U				0,06679
A320-232	A	3_D			0,379853	0,100263
A320-232	A	FULL_D			0,369833	0,121141
A320-232	A	ZERO_A				0,054309
A320-232	D	1				0,065822
A320-232	D	1+F	0,007626	0,395674		0,069873
A320-232	D	ZERO				0,05332
A321-232	A	1_A				0,064258
A321-232	A	2_D				0,101798
A321-232	A	2_U				0,074849
A321-232	A	3_D			0,368096	0,112676
A321-232	A	FULL_D			0,357761	0,119073
A321-232	A	ZERO_A				0,057183

ACFT_ID	OP_TYPE	FLAP_ID	B (ft/lb)	C (kt/ $\sqrt{\text{lb}}$)	D (kt/ $\sqrt{\text{lb}}$)	R
A321-232	D	1				0,071631
A321-232	D	1+F	0,007524	0,390238		0,075946
A321-232	D	ZERO				0,056647
A330-301	A	1_A				0,057783
A330-301	A	2_D				0,081654
A330-301	A	2_U				0,064098
A330-301	A	3_D			0,229065	0,092737
A330-301	A	FULL_D			0,222802	0,100779
A330-301	A	ZERO_A				0,047685
A330-301	D	1				0,059866
A330-301	D	1+F	0,002905	0,247076		0,061736
A330-301	D	ZERO				0,046057
A330-343	A	1_A				0,055464
A330-343	A	2_D				0,083569
A330-343	A	2_U				0,063042
A330-343	A	3_D			0,229705	0,092555
A330-343	A	FULL_D			0,222498	0,10202
A330-343	A	ZERO_A				0,046224
A330-343	D	1				0,05926
A330-343	D	1+F	0,0029	0,245211		0,062365
A330-343	D	ZERO				0,044593
A340-211	A	1_A				0,063657
A340-211	A	2_D				0,092945
A340-211	A	2_U				0,071673
A340-211	A	3_D			0,224603	0,101734
A340-211	A	FULL_D			0,220432	0,108554
A340-211	A	ZERO_A				0,051221
A340-211	D	1				0,068547
A340-211	D	1+F	0,002605	0,223635		0,073134
A340-211	D	ZERO				0,048646
A340-642	A	1_A				0,054416
A340-642	A	2_D				0,087508
A340-642	A	2_U				0,067996

ACFT_ID	OP_TYPE	FLAP_ID	B (ft/lb)	C (kt/ $\sqrt{\text{lb}}$)	D (kt/ $\sqrt{\text{lb}}$)	R
A340-642	A	3_D			0,213821	0,100473
A340-642	A	FULL_D			0,20733	0,105616
A340-642	A	ZERO_A				0,051608
A340-642	D	1				0,06118
A340-642	D	1+F	0,002423	0,225716		0,06743
A340-642	D	ZERO				0,051433
A380-841	A	A_1+F				0,055657
A380-841	A	A_2_D				0,081906
A380-841	A	A_2_U				0,064109
A380-841	A	A_3_D			0,154745	0,101662
A380-841	A	A_FULL			0,154745	0,107331
A380-841	A	ZERO_A				0,050279
A380-841	D	D_1				0,053173
A380-841	D	D_1+F	0,00125	0,159626		0,068055
A380-841	D	ZERO				0,050472
A380-861	A	A_1+F				0,058557
A380-861	A	A_2_D				0,081967
A380-861	A	A_2_U				0,06558
A380-861	A	A_3_D			0,154745	0,101738
A380-861	A	A_FULL			0,154745	0,108118
A380-861	A	ZERO_A				0,048776
A380-861	D	D_1				0,053241
A380-861	D	D_1+F	0,00125	0,159567		0,070602
A380-861	D	ZERO				0,049623
BAC111	A	D-45			0,49076	0,139207
BAC111	A	U-INT				0,106398
BAC111	D	8	0,01569	0,54382		0,082179
BAC111	D	INT1				0,07359
BAC111	D	ZERO				0,065
BAE146	A	D-18			0,61667	0,119715
BAE146	A	D-24			0,61667	0,138371
BAE146	A	D-33			0,45555	0,153186
BAE146	A	U-18				0,0818

ACFT_ID	OP_TYPE	FLAP_ID	B (ft/lb)	C (kt/ $\sqrt{\text{lb}}$)	D (kt/ $\sqrt{\text{lb}}$)	R
BAE146	A	U-24				0,095298
BAE146	D	18	0,009678	0,49296		0,13241
BAE146	D	24	0,008979	0,45846		0,1412
BAE146	D	30	0,008173	0,43179		0,15287
BAE146	D	ZERO				0,083096
BAE300	A	D-18			0,60557	0,116925
BAE300	A	D-24			0,60557	0,134808
BAE300	A	D-33			0,4511	0,149009
BAE300	A	U-18				0,08058
BAE300	A	U-24				0,093519
BAE300	D	18	0,009449	0,49847		0,1279
BAE300	D	24	0,008341	0,462		0,1352
BAE300	D	30	0,00775	0,43351		0,14711
BAE300	D	ZERO				0,081866
BEC58P	A	D-15				0,14885
BEC58P	A	D-30			1,33492	0,16
BEC58P	D	TO	0,100258	1,28098		0,1377
BEC58P	D	ZERO				0,125381
CIT3	A	D-40			0,966375	0,147159
CIT3	A	D-INTR				0,130842
CIT3	D	10				0,092263
CIT3	D	20	0,04284	0,947523		0,114525
CIT3	D	ZERO				0,07
CL600	A	D-45			0,766248	0,169002
CL600	A	D-INTR				0,128747
CL600	D	10				0,079246
CL600	D	20	0,028225	0,780719		0,088492
CL600	D	ZERO				0,07
CL601	A	D-45			0,769487	0,163669
CL601	A	D-INTR				0,122639
CL601	D	10				0,075805
CL601	D	20	0,032183	0,780565		0,081609
CL601	D	ZERO				0,07

ACFT_ID	OP_TYPE	FLAP_ID	B (ft/lb)	C (kt/√lb)	D (kt/√lb)	R
CNA172	A	10-D			1,3132	0,0994
CNA172	A	30-D			1,2526	0,1516
CNA172	A	ZERO-D				0,096
CNA172	D	10-C	0,0992	1,0304		0,1446
CNA172	D	CRUISE				0,096
CNA172	D	ZERO-C	0,1025	1,1112		0,0831
CNA182	A	F10APP				0,122
CNA182	A	F30APP			1,285	0,151
CNA182	D	F-20D	0,058	1,204		0,17
CNA182	D	ZERO				0,127
CNA182	D	ZERO-A				0,127
CNA182	D	ZERO-C				0,097
CNA182	D	ZERO-T				0,103
CNA206	A	10_D				0,105632
CNA206	A	40_D			1,23852	0,169084
CNA206	D	20_T	0,055005	1,02562		0,136998
CNA206	D	ZERO_C				0,09563
CNA206	D	ZERO_T	0,055005	1,02562		0,106327
CNA208	A	F30APP			0,867722	0,099468
CNA208	A	ZERO-A				0,089802
CNA208	D	F-20D	0,033202	0,74833		0,105087
CNA208	D	ZERO	0,05003	0,887307		0,089802
CNA208	D	ZERO-C				0,087252
CNA208	D	ZERO-T				0,060282
CNA20T	A	10_D				0,109615
CNA20T	A	40_D			1,32574	0,211577
CNA20T	D	20_T	0,054669	1,045287		0,13795
CNA20T	D	ZERO_C				0,101535
CNA20T	D	ZERO_T	0,054669	0,959417		0,099791
CNA441	A	D-INTR				0,141579
CNA441	A	D-L			1,02329	0,162936
CNA441	D	TO	0,072722	1,10834		0,120222
CNA441	D	ZERO				0,096518

ACFT_ID	OP_TYPE	FLAP_ID	B (ft/lb)	C (kt/ $\sqrt{\text{lb}}$)	D (kt/ $\sqrt{\text{lb}}$)	R
CNA500	A	D-35			0,991547	0,147335
CNA500	A	D-INTR				0,113809
CNA500	D	1				0,080282
CNA500	D	12	0,054342	0,956752		0,090564
CNA500	D	ZERO				0,07
CNA510	A	A_15			1,073624	0,088506
CNA510	A	A_35			1,002913	0,126185
CNA510	D	D_15	0,07051	1,179843		0,097415
CNA510	D	ZERO_C				0,088914
CNA510	D	ZERO_D	0,090811	1,347624		0,103158
CNA525C	A	A_15			1,012614	0,106795
CNA525C	A	A_35			0,946574	0,126615
CNA525C	D	D-15	0,053355	0,993147		0,096525
CNA525C	D	ZERO_C				0,085
CNA525C	D	ZERO_D	0,061279	1,065348		0,09129
CNA55B	A	A_15			1,01427	0,118086
CNA55B	A	A_35			0,9553	0,200794
CNA55B	D	D_15	0,05628	1,080923		0,128052
CNA55B	D	ZERO_C				0,10833
CNA55B	D	ZERO_D	0,063189	1,159835		0,119835
CNA560E	D	15	0,054336	1,014289		0,122203
CNA560E	A	15 U			0,919106	0,099403
CNA560E	A	35 D			0,870372	0,130841
CNA560E	D	7	0,059522	1,061591		0,11951
CNA560E	D	ZERO				0,122635
CNA560U	D	15	0,038136	1,069934		0,13523
CNA560U	D	7	0,041179	1,10518		0,12699
CNA560U	A	7_APP				0,12699
CNA560U	A	D 15			0,86464	0,088125
CNA560U	A	D 35			0,811918	0,132402
CNA560U	D	ZERO				0,07
CNA560XL	D	15	0,030657	1,045811		0,13852
CNA560XL	D	7	0,035712	1,095308		0,13505

ACFT_ID	OP_TYPE	FLAP_ID	B (ft/lb)	C (kt/√lb)	D (kt/√lb)	R
CNA560XL	A	D 15U			0,91189	0,08555
CNA560XL	A	D 35D			0,86179	0,126192
CNA560XL	D	ZERO				0,074551
CNA680	D	15	0,027468	0,725152		0,127804
CNA680	A	15 GU			0,717794	0,093247
CNA680	A	35 GD			0,662727	0,146827
CNA680	D	7	0,030105	0,764412		0,122083
CNA680	D	ZERO				0,105329
CNA750	A	15_GD			0,753068	0,174519
CNA750	A	15_GU			0,753068	0,146147
CNA750	A	35_GD			0,714646	0,250382
CNA750	A	5_GU			0,799175	0,118139
CNA750	D	5	0,038446	0,82511		0,122657
CNA750	D	15	0,034761	0,787004		0,12822
CNA750	D	ZERO				0,096475
CONCRD	A	D-L			0,349148	0,205927
CONCRD	A	U-L				0,183067
CONCRD	D	CL1				0,13294
CONCRD	D	TO	0,008051	0,338363		0,13294
CONCRD	D	ZERO				0,13294
CRJ9-ER	A	20				0,0976
CRJ9-ER	A	D-45			0,5801	0,1551
CRJ9-ER	A	U-45				0,1504
CRJ9-ER	A	ZERO				0,0655
CRJ9-ER	D	0-204				0,0599
CRJ9-ER	D	0-250				0,0641
CRJ9-ER	D	D-8	0,0177	0,5902		0,0978
CRJ9-ER	D	U-8				0,0775
CRJ9-LR	A	20				0,0976
CRJ9-LR	A	D-45			0,5801	0,1551
CRJ9-LR	A	U-45				0,1504
CRJ9-LR	A	ZERO				0,0655
CRJ9-LR	D	0-204				0,0599

ACFT_ID	OP_TYPE	FLAP_ID	B (ft/lb)	C (kt/ \sqrt{lb})	D (kt/ \sqrt{lb})	R
CRJ9-LR	D	0-250				0,0641
CRJ9-LR	D	D-8	0,0177	0,5902		0,0978
CRJ9-LR	D	U-8				0,0775
CVR580	A	D-28			0,51972	0,118937
CVR580	A	D-40			0,49138	0,124222
CVR580	D	10	0,028303	0,540116		0,130717
CVR580	D	INTR				0,102858
CVR580	D	ZERO				0,075
DC1010	A	D-35			0,251236	0,132645
DC1010	A	D-50			0,244243	0,164729
DC1010	A	U-35				0,127457
DC1010	A	U-50				0,161155
DC1010	D	5				0,079893
DC1010	D	10	0,00356	0,261942		0,101376
DC1010	D	INT				0,068522
DC1010	D	ZERO				0,057149
DC1030	A	D-35			0,2534	0,13
DC1030	A	U-20				0,104
DC1030	D	20	0,003091	0,2434		0,104
DC1030	D	INT1				0,09454
DC1030	D	INT2				0,07307
DC1030	D	ZERO				0,06519
DC1040	A	D-35			0,254879	0,121114
DC1040	A	D-50			0,247241	0,151007
DC1040	A	U-35				0,114222
DC1040	A	U-50				0,145481
DC1040	D	5				0,082503
DC1040	D	15	0,004009	0,272697		0,111044
DC1040	D	INT				0,071264
DC1040	D	ZERO				0,060025
DC3	A	D-45			0,597793	0,155222
DC3	A	U-INT				0,133361
DC3	D	TO	0,019837	0,619256		0,123784

ACFT_ID	OP_TYPE	FLAP_ID	B (ft/lb)	C (kt/ $\sqrt{\text{lb}}$)	D (kt/ $\sqrt{\text{lb}}$)	R
DC3	D	ZERO				0,1115
DC6	A	D-INTR				0,10199
DC6	A	D-L			0,294594	0,125979
DC6	D	TO	0,007829	0,430006		0,08204
DC6	D	ZERO				0,078
DC850	A	D-35			0,328558	0,129965
DC850	A	D-50			0,313281	0,149354
DC850	A	U-35				0,126751
DC850	A	U-50				0,145337
DC850	D	15	0,005206	0,323443		0,090417
DC850	D	25	0,004708	0,315832		0,103092
DC850	D	INT				0,074401
DC850	D	ZERO				0,058535
DC860	A	D-35			0,312879	0,117758
DC860	A	D-50			0,304526	0,130913
DC860	A	U-35				0,115049
DC860	A	U-50				0,12766
DC860	D	12	0,004899	0,320082		0,090214
DC860	D	23	0,004572	0,304797		0,095953
DC860	D	INT				0,071703
DC860	D	ZERO				0,05319
DC870	A	D-35			0,312879	0,117758
DC870	A	D-50			0,304526	0,130913
DC870	A	U-35				0,115049
DC870	A	U-50				0,12766
DC870	D	12	0,004899	0,320082		0,090214
DC870	D	23	0,004572	0,304797		0,095953
DC870	D	INT				0,071703
DC870	D	ZERO				0,05319
DC8QN	A	D-35			0,312879	0,117758
DC8QN	A	D-50			0,304526	0,130913
DC8QN	A	U-35				0,115049
DC8QN	A	U-50				0,12766

ACFT_ID	OP_TYPE	FLAP_ID	B (ft/lb)	C (kt/√lb)	D (kt/√lb)	R
DC8QN	D	12	0,004899	0,320082		0,090214
DC8QN	D	23	0,004572	0,304797		0,095953
DC8QN	D	INT				0,071703
DC8QN	D	ZERO				0,05319
DC910	A	D-35			0,480101	0,134177
DC910	A	D-50			0,445486	0,157948
DC910	A	U-15				0,087963
DC910	A	U-35				0,130625
DC910	A	U-50				0,153365
DC910	D	5	0,012996	0,49557		0,07757
DC910	D	15	0,010618	0,477234		0,087963
DC910	D	INT				0,076753
DC910	D	ZERO				0,075935
DC930	A	D-35			0,470211	0,135075
DC930	A	D-50			0,438965	0,165052
DC930	A	U-15				0,092489
DC930	A	U-35				0,131559
DC930	A	U-50				0,155925
DC930	D	5	0,012098	0,4899		0,084985
DC930	D	15	0,010507	0,471774		0,092489
DC930	D	INT				0,076701
DC930	D	ZERO				0,068416
DC93LW	A	D-35			0,470211	0,135075
DC93LW	A	D-50			0,438965	0,165052
DC93LW	A	U-15				0,092489
DC93LW	A	U-35				0,131559
DC93LW	A	U-50				0,155925
DC93LW	D	5	0,012098	0,4899		0,084985
DC93LW	D	15	0,010507	0,471774		0,092489
DC93LW	D	INT				0,076701
DC93LW	D	ZERO				0,068416
DC950	A	D-35			0,468147	0,135234
DC950	A	D-50			0,442406	0,160018

ACFT_ID	OP_TYPE	FLAP_ID	B (ft/lb)	C (kt/ \sqrt{lb})	D (kt/ \sqrt{lb})	R
DC950	A	U-15				0,092489
DC950	A	U-35				0,131677
DC950	A	U-50				0,155399
DC950	D	5	0,012098	0,4899		0,084985
DC950	D	15	0,010507	0,471774		0,092489
DC950	D	INTR				0,076701
DC950	D	ZERO				0,068416
DC95HW	A	D-35			0,468147	0,135234
DC95HW	A	D-50			0,442406	0,160018
DC95HW	A	U-15				0,092489
DC95HW	A	U-35				0,131677
DC95HW	A	U-50				0,155399
DC95HW	D	5	0,012098	0,4899		0,084985
DC95HW	D	15	0,010507	0,471774		0,092489
DC95HW	D	INTR				0,076701
DC95HW	D	ZERO				0,068416
DC9Q7	A	D-35			0,480101	0,134177
DC9Q7	A	D-50			0,445486	0,157948
DC9Q7	A	U-15				0,087963
DC9Q7	A	U-35				0,130625
DC9Q7	A	U-50				0,153365
DC9Q7	D	5	0,012996	0,49557		0,07757
DC9Q7	D	15	0,010618	0,477234		0,087963
DC9Q7	D	INT				0,076753
DC9Q7	D	ZERO				0,075935
DC9Q9	A	D-35			0,470211	0,135075
DC9Q9	A	D-50			0,438965	0,165052
DC9Q9	A	U-15				0,092489
DC9Q9	A	U-35				0,131559
DC9Q9	A	U-50				0,155925
DC9Q9	D	5	0,012098	0,4899		0,084985
DC9Q9	D	15	0,010507	0,471774		0,092489
DC9Q9	D	INT				0,076701

ACFT_ID	OP_TYPE	FLAP_ID	B (ft/lb)	C (kt/√lb)	D (kt/√lb)	R
DC9Q9	D	ZERO				0,068416
DHC6	A	D-INTR				0,125975
DHC6	A	D-L			0,577068	0,176949
DHC6	D	INTR				0,090222
DHC6	D	TO	0,031032	0,787095		0,105443
DHC6	D	ZERO				0,075
DHC6QP	A	D-INTR				0,125975
DHC6QP	A	D-L			0,577068	0,176949
DHC6QP	D	INTR				0,090222
DHC6QP	D	TO	0,031032	0,787095		0,105443
DHC6QP	D	ZERO				0,075
DHC7	A	D-25			0,51353	0,127688
DHC7	A	D-INTR				0,117133
DHC7	D	10				0,117133
DHC7	D	25	0,009556	0,466702		0,159266
DHC7	D	ZERO				0,075
DHC8	A	D-15			0,54969	0,092335
DHC8	A	D-35			0,50961	0,10086
DHC8	A	D-5			0,60123	0,087745
DHC8	A	U-15				0,080204
DHC8	A	U-5				0,073647
DHC8	D	5	0,017289	0,61342		0,07808
DHC8	D	15	0,017361	0,56668		0,08519
DHC8	D	ZERO				0,072424
DHC830	A	D-10			0,62986	0,091024
DHC830	A	D-15			0,60123	0,094958
DHC830	A	D-35			0,55542	0,103483
DHC830	A	U-10				0,079221
DHC830	A	U-15				0,084139
DHC830	D	5	0,017836	0,61764		0,070652
DHC830	D	10	0,015165	0,570532		0,076309
DHC830	D	15	0,014403	0,549595		0,080292
DHC830	D	INT	0,019987	0,659514		0,067572

ACFT_ID	OP_TYPE	FLAP_ID	B (ft/lb)	C (kt/ \sqrt{lb})	D (kt/ \sqrt{lb})	R
DHC830	D	ZERO				0,068308
DO228	A	F30APP			0,75885	0,11911
DO228	A	ZERO-A				0,10717
DO228	D	FLAPS1	0,02196	0,80401		0,09042
DO228	D	ZERO	0,02745	0,86388		0,10717
DO228	D	ZERO-C				0,14459
DO228	D	ZERO-T				0,09218
DO328	A	F32APP			0,638	0,0961
DO328	A	ZERO-A				0,0916
DO328	D	F12-D	0,016	0,666		0,0664
DO328	D	ZERO				0,0916
DO328	D	ZERO-C				0,1206
ECLIPSE500	A	A_A_DN			1,273746	0,133462
ECLIPSE500	A	A_T_DN				0,178304
ECLIPSE500	D	TO_DN	0,100203	1,381422		0,105314
ECLIPSE500	D	TO_UP		1,381422		0,086185
ECLIPSE500	D	UP_DN		1,690947		0,103009
ECLIPSE500	D	UP_UP		1,690947		0,073313
EMB120	A	D-25			0,837	0,0801
EMB120	A	D-45			0,782	0,1305
EMB120	D	15	0,0297	0,82		0,1014
EMB120	D	ZERO		0,929		0,0834
EMB145	A	D-22			0,6836	0,1291
EMB145	A	D-45			0,6811	0,1809
EMB145	D	9		0,6503		0,0825
EMB145	D	9-GEAR	0,0218	0,6562		0,1048
EMB145	D	ZERO				0,0691
EMB14L	A	D-22			0,6836	0,1291
EMB14L	D	9		0,6503		0,083
EMB14L	D	9-GEAR	0,0212	0,6562		0,083
EMB14L	D	D-45		0,6811		0,1809
EMB14L	D	ZERO				0,0694
EMB170	D	1	0,015720	0,579870		0,076830

ACFT_ID	OP_TYPE	FLAP_ID	B (ft/lb)	C (kt/ $\sqrt{\text{lb}}$)	D (kt/ $\sqrt{\text{lb}}$)	R
EMB170	A	FULL			0,498900	0,145550
EMB170	D	ZERO				0,066180
EMB175	D	1	0,015900	0,578990		0,077300
EMB175	A	FULL			0,498200	0,145800
EMB175	D	ZERO				0,066000
EMB190	D	1	0,012300	0,494610		0,082600
EMB190	A	FULL			0,434400	0,137100
EMB190	D	ZERO				0,066400
EMB195	D	1	0,012200	0,494520		0,083100
EMB195	A	FULL			0,433600	0,137400
EMB195	D	ZERO				0,067400
F10062	A	D-42			0,4731	0,1565
F10062	A	U-INT				0,1124
F10062	D	INT2				0,0904
F10062	D	TO	0,0122	0,5162		0,0683
F10062	D	ZERO				0,0683
F10065	A	D-42			0,4731	0,1565
F10065	A	U-INT				0,1129
F10065	D	INT2				0,0911
F10065	D	TO	0,0123	0,521		0,0693
F10065	D	ZERO				0,0693
F28MK2	A	D-42			0,5334	0,1677
F28MK2	A	U-INTR				0,1248
F28MK2	D	6	0,0171	0,6027		0,0793
F28MK2	D	INT2				0,1033
F28MK2	D	ZERO				0,0819
F28MK4	A	D-42			0,5149	0,1619
F28MK4	A	U-INTR				0,1187
F28MK4	D	6	0,01515	0,5731		0,0749
F28MK4	D	INT2				0,0971
F28MK4	D	ZERO				0,0755
FAL20	A	D-25			0,804634	0,117238
FAL20	A	D-40			0,792624	0,136348

ACFT_ID	OP_TYPE	FLAP_ID	B (ft/lb)	C (kt/ $\sqrt{\text{lb}}$)	D (kt/ $\sqrt{\text{lb}}$)	R
FAL20	D	10	0,035696	0,807797		0,098781
FAL20	D	INTR				0,084391
FAL20	D	ZERO				0,07
GII	A	L-0-U				0,0751
GII	A	L-10-U				0,0852
GII	D	L-20-D				0,1138
GII	D	L-39-D		0,5822		0,1742
GII	D	T-0-U				0,0814
GII	D	T-10-U				0,0884
GII	D	T-20-D	0,02	0,634		0,1159
GIIB	A	L-0-U				0,0722
GIIB	A	L-10-U				0,0735
GIIB	D	L-20-D				0,1091
GIIB	D	L-39-D		0,562984		0,1509
GIIB	D	T-0-U				0,0738
GIIB	D	T-10-U				0,0729
GIIB	D	T-20-D	0,0162	0,583		0,1063
GIV	A	L-0-U				0,06
GIV	A	L-39-D			0,5805	0,1403
GIV	D	L-20-D				0,1063
GIV	D	T-0-U				0,0586
GIV	D	T-10-U				0,0666
GIV	D	T-20-D	0,0146	0,5798		0,1035
GIV	D	T-20-U				0,0797
GV	A	L-20-D				0,0974
GV	A	L-20-U				0,0749
GV	A	L-39-D			0,4908	0,1328
GV	D	L-0-U				0,0617
GV	D	T-0-U				0,058
GV	D	T-10-U				0,0606
GV	D	T-20-D	0,01178	0,516		0,0953
GV	D	T-20-U				0,0743
HS748A	A	D-30			0,45813	0,13849

ACFT_ID	OP_TYPE	FLAP_ID	B (ft/lb)	C (kt/ \sqrt{lb})	D (kt/ \sqrt{lb})	R
HS748A	A	D-INTR				0,106745
HS748A	D	INTR				0,088176
HS748A	D	TO	0,012271	0,542574		0,101351
HS748A	D	ZERO				0,075
IA1125	A	D-40			0,967478	0,136393
IA1125	A	D-INTR				0,118618
IA1125	D	12	0,040745	0,963488		0,100843
IA1125	D	INTR				0,085422
IA1125	D	ZERO				0,07
L1011	A	D-33			0,286984	0,137671
L1011	A	D-42			0,256389	0,155717
L1011	D	10	0,004561	0,265314		0,093396
L1011	D	22	0,004759	0,251916		0,105083
L1011	D	INTR				0,07959
L1011	D	ZERO				0,06243
L10115	A	D-33			0,262728	0,140162
L10115	A	D-42			0,256123	0,155644
L10115	D	10	0,004499	0,265314		0,093396
L10115	D	22	0,004695	0,251916		0,105083
L10115	D	INTR				0,07959
L10115	D	ZERO				0,06243
L188	A	D-100			0,436792	0,174786
L188	A	D-78-%			0,456156	0,122326
L188	D	39-%	0,009995	0,420533		0,142992
L188	D	78-%	0,010265	0,404302		0,159974
L188	D	INTR				0,120987
L188	D	ZERO				0,082
LEAR25	A	D-40			1,28239	0,176632
LEAR25	A	D-INTR				0,149986
LEAR25	D	10				0,09667
LEAR25	D	20	0,082866	1,27373		0,12334
LEAR25	D	ZERO				0,07
LEAR35	A	D-40			1,08756	0,150688

ACFT_ID	OP_TYPE	FLAP_ID	B (ft/lb)	C (kt/ \sqrt{lb})	D (kt/ \sqrt{lb})	R
LEAR35	A	D-INTR				0,129456
LEAR35	D	10				0,089112
LEAR35	D	20	0,043803	1,05985		0,108224
LEAR35	D	ZERO				0,07
MD11GE	D	10	0,003812	0,2648		0,0843
MD11GE	D	15	0,003625	0,2578		0,0891
MD11GE	D	20	0,003509	0,2524		0,0947
MD11GE	D	25	0,003443	0,2481		0,1016
MD11GE	D	0/EXT				0,0692
MD11GE	D	0/RET				0,0551
MD11GE	D	ZERO				0,0551
MD11PW	D	10	0,003829	0,265		0,08425
MD11PW	D	15	0,003675	0,2576		0,08877
MD11PW	D	20	0,003545	0,2526		0,09472
MD11PW	D	25	0,003494	0,2487		0,1018
MD11PW	D	0/EXT				0,0691
MD11PW	D	0/RET				0,05512
MD11PW	D	ZERO				0,05512
MD81	D	11	0,009276	0,4247		0,07719
MD81	D	INT1				0,07643
MD81	D	INT2				0,06313
MD81	D	INT3				0,06156
MD81	D	INT4				0,06366
MD81	D	T_15	0,009369	0,420798		0,0857
MD81	D	T_INT				0,0701
MD81	D	T_ZERO				0,061
MD81	D	ZERO				0,06761
MD82	D	11	0,009248	0,4236		0,07969
MD82	D	INT1				0,07625
MD82	D	INT2				0,06337
MD82	D	INT3				0,06196
MD82	D	INT4				0,0634
MD82	D	T_15	0,009267	0,420216		0,086

ACFT_ID	OP_TYPE	FLAP_ID	B (ft/lb)	C (kt/ $\sqrt{\text{lb}}$)	D (kt/ $\sqrt{\text{lb}}$)	R
MD82	D	T_INT				0,065
MD82	D	T_ZERO				0,061
MD82	D	ZERO				0,06643
MD83	D	11	0,009301	0,4227		0,0798
MD83	D	INT1				0,07666
MD83	D	INT2				0,0664
MD83	D	INT3				0,06247
MD83	D	INT4				0,06236
MD83	D	T_15	0,009384	0,420307		0,086
MD83	D	T_INT				0,0664
MD83	D	T_ZERO				0,0611
MD83	D	ZERO				0,06573
MD9025	A	D-28			0,4118	0,1181
MD9025	A	D-40			0,4003	0,1412
MD9025	A	U-0			0,4744	0,0876
MD9025	D	EXT/06	0,010708	0,458611		0,070601
MD9025	D	EXT/11	0,009927	0,441118		0,073655
MD9025	D	EXT/18	0,009203	0,421346		0,083277
MD9025	D	EXT/24	0,008712	0,408301		0,090279
MD9025	D	RET/0				0,05186
MD9028	A	D-28			0,4118	0,1181
MD9028	A	D-40			0,4003	0,1412
MD9028	A	U-0			0,4744	0,0876
MD9028	D	EXT/06	0,010993	0,463088		0,070248
MD9028	D	EXT/11	0,010269	0,446501		0,072708
MD9028	D	EXT/18	0,009514	0,426673		0,082666
MD9028	D	EXT/24	0,008991	0,413409		0,090018
MD9028	D	RET/0				0,05025
MU3001	A	D-30			1,07308	0,147487
MU3001	A	D-INTR				0,114684
MU3001	D	1	0,065703	1,1529		0,08188
MU3001	D	10	0,055318	1,0729		0,09285
MU3001	D	ZERO				0,07

ACFT_ID	OP_TYPE	FLAP_ID	B (ft/lb)	C (kt/ $\sqrt{\text{lb}}$)	D (kt/ $\sqrt{\text{lb}}$)	R
PA30	A	27-A			1,316667	0,104586
PA30	A	ZERO-A				0,078131
PA30	D	15-D	0,100146	1,166667		0,154071
PA30	D	ZERO-D				0,067504
PA42	A	30-DN			1,09213	0,14679
PA42	A	ZERO-A				0,087856
PA42	D	ZER-DN	0,06796	1,011055		0,08088
PA42	D	ZERO				0,087856
PA42	D	ZERO-C				0,139096
PA42	D	ZERO-T				0,07651
SD330	A	D-15			0,746802	0,109263
SD330	A	D-35			0,702872	0,143475
SD330	D	10	0,031762	0,727556		0,138193
SD330	D	INTR				0,106596
SD330	D	ZERO				0,075
SF340	A	D-35			0,75674	0,147912
SF340	A	D-INTR				0,111456
SF340	D	5				0,105831
SF340	D	15	0,026303	0,746174		0,136662
SF340	D	ZERO				0,075

Table I-2
Aircrafts

ACFTID	Description	Engine Type	Numb of Engines	Weight Class	Owner Category	MGTOW (lb)	MGLW (lb)	Max Landing Dist (ft)	Max Sea Level Static Thrust (lb)	Noise Chapter	NPD_ID	Power Parameter	Approach Spectral Class ID	Departure Spectral Class ID	Lateral Directivity Identifier
1900D	Beech 1900D/PT6A67	Turbo-prop	2	Large	Commercial	16 950	14 940	1 696	3 367	1	PT6A67	CNT (lb)	213	109	Prop
707	Boeing 707-120/JT3C	Jet	4	Heavy	Commercial	302 400	188 900	6 682	10 120	1	JT4A	CNT (lb)	208	107	Wing
707120	Boeing 707-120B/JT3D-3	Jet	4	Heavy	Commercial	302 400	188 900	6 893	14 850	1	JT3D	CNT (lb)	208	107	Wing
707320	Boeing 707-320B/JT3D-7	Jet	4	Heavy	Commercial	334 000	247 000	5 622	19 000	1	JT3D	CNT (lb)	208	107	Wing
707QN	Boeing 707-320B/JT3D-7QN	Jet	4	Heavy	Commercial	334 000	247 000	5 622	19 000	2	JT3DQ	CNT (lb)	208	106	Wing
717200	Boeing 717-200/BR 715	Jet	2	Large	Commercial	121 000	110 000	4 600	18 000	3	BR715	CNT (lb)	203	105	Fuselage
720	Boeing 720/JT3C	Jet	4	Large	Commercial	223 500	155 600	4 871	10 120	1	JT4A	CNT (lb)	208	107	Wing
720B	Boeing 720B/JT3D-3	Jet	4	Large	Commercial	234 000	175 000	5 717	18 000	1	JT3D	CNT (lb)	208	107	Wing
727100	Boeing 727-100/JT8D-7	Jet	3	Large	Commercial	169 500	142 500	4 867	14 000	1	3JT8D	CNT (lb)	201	101	Fuselage
727200	Boeing 727-200/JT8D-7	Jet	3	Large	Commercial	217 600	163 300	5 571	11 895	1	3JT8D	CNT (lb)	201	101	Fuselage
727D15	Boeing 727-200/JT8D-15	Jet	3	Large	Commercial	208 000	169 000	4 922	15 500	1	3JT8D	CNT (lb)	201	101	Fuselage
727D17	Boeing 727-200/JT8D-17	Jet	3	Large	Commercial	208 000	169 000	5 444	16 000	2	3JT8DQ	CNT (lb)	201	101	Fuselage
727EM1	FEDX 727-100/JT8D-7	Jet	3	Large	Commercial	169 500	142 500	4 867	14 000	3	3JT8E7	CNT (lb)	201	101	Fuselage

ACFTID	Description	Engine type	Numb of Engines	Weight Class	Owner Category	MGTOW (lb)	MCLW (lb)	Max Landing Dist (ft)	Max Sea Level Static Thrust (lb)	Noise Chapter	NPD_ID	Power Parameter	Approach Spectral Class ID	Departure Spectral Class ID	Lateral Directivity Identifier
727EM2	FEDX 727-200//T8D-15	Jet	3	Large	Commercial	208 000	169 000	4 922	15 500	3	3JT8E5	CNT (lb)	201	101	Fuselage
727Q15	Boeing 727-200//T8D-15QN	Jet	3	Large	Commercial	208 000	169 000	4 922	15 500	2	3JT8DQ	CNT (lb)	201	101	Fuselage
727Q7	Boeing 727-100//T8D-7QN	Jet	3	Large	Commercial	169 500	142 500	4 867	14 000	2	3JT8DQ	CNT (lb)	201	101	Fuselage
727Q9	Boeing 727-200//T8D-9	Jet	3	Large	Commercial	191 000	160 000	5 444	14 500	2	3JT8DQ	CNT (lb)	201	101	Fuselage
727QF	UPS 727-100 22C 25C	Jet	3	Large	Commercial	169 000	142 500	4 448	15 380	3	TAY651	CNT (lb)	201	101	Fuselage
737	Boeing 737//T8D-9	Jet	2	Large	Commercial	109 000	98 000	3 900	14 500	1	2JT8DW	CNT (lb)	201	101	Wing
737300	Boeing 737-300//CFM56-3B-1	Jet	2	Large	Commercial	135 000	114 000	4 580	20 000	3	CFM563	CNT (lb)	202	102	Wing
7373B2	Boeing 737-300//CFM56-3B-2	Jet	2	Large	Commercial	139 500	114 000	4 580	22 000	3	CFM563	CNT (lb)	202	102	Wing
737400	Boeing 737-400//CFM56-3C-1	Jet	2	Large	Commercial	150 000	124 000	5 062	23 500	3	CFM563	CNT (lb)	202	102	Wing
737500	Boeing 737-500//CFM56-3C-1	Jet	2	Large	Commercial	133 500	111 000	4 551	20 000	3	CFM563	CNT (lb)	202	102	Wing
737700	Boeing 737-700//CFM56-7B24	Jet	2	Large	Commercial	154 500	129 200	4 445	24 000	3	CF567B	CNT (lb)	203	104	Wing
737800	Boeing 737-800//CFM56-7B26	Jet	2	Large	Commercial	174 200	146 300	5 435	26 300	3	CF567B	CNT (lb)	203	104	Wing
737D17	Boeing 737-200//T8D-17	Jet	2	Large	Commercial	124 000	107 000	4 244	16 000	2	2JT8QW	CNT (lb)	201	101	Wing

ACFTID	Description	Engine Type	Numb of Engines	Weight Class	Owner Category	MGTOW (lb)	MCLW (lb)	Max Landing Dist. (ft)	Max Sea Level Static Thrust (lb)	Noise Chapter	NPD_ID	Power Parameter	Approach Spectral Class ID	Departure Spectral Class ID	Lateral Directivity Identifier
737N17	Boeing 737-200/JT8D-17 Nordam B737 LGW Hushkit	Jet	2	Large	Commercial	124 000	107 000	4 244	16 000	3	2JT8DN	CNT (lb)	202	104	Wing
737N9	Boeing 737/JT8D-9 Nordam B737 LGW Hushkit	Jet	2	Large	Commercial	109 000	98 000	3 900	14 500	3	2JT8DN	CNT (lb)	202	104	Wing
737QN	Boeing 737/JT8D-9QN	Jet	2	Large	Commercial	109 000	98 000	3 900	14 500	2	2JT8QW	CNT (lb)	201	101	Wing
747100	Boeing 747-100/JT9D8D	Jet	4	Heavy	Commercial	733 000	516 600	5 727	33 042	2	JT9D8D	CNT (lb)	209	107	Wing
74710Q	Boeing 747-100/JT9D-7QN	Jet	4	Heavy	Commercial	733 000	564 000	6 200	45 500	3	JT9DFL	CNT (lb)	207	107	Wing
747200	Boeing 747-200/JT9D-7	Jet	4	Heavy	Commercial	775 000	564 000	6 200	45 500	3	JT9DFL	CNT (lb)	207	107	Wing
74720A	Boeing 747-200/JT9D-7A	Jet	4	Heavy	Commercial	785 000	564 000	6 200	46 300	3	JT9D7Q	CNT (lb)	207	107	Wing
74720B	Boeing 747-200/JT9D-7Q	Jet	4	Heavy	Commercial	800 000	630 000	6 200	53 000	3	JT9D7Q	CNT (lb)	207	107	Wing
747400	Boeing 747-400/PW4056	Jet	4	Heavy	Commercial	875 000	652 000	6 989	56 800	3	PW4056	CNT (lb)	207	107	Wing
7478	Boeing 747-8F/GEEx-2B67	Jet	4	Heavy	Commercial	987 000	757 000	7 900	68 000	4	GENX67	CNT (lb)	205	107	Wing
747SP	Boeing 747SP/JT9D-7	Jet	4	Heavy	Commercial	702 000	475 000	5 911	45 500	3	JT9DFL	CNT (lb)	207	107	Wing
757300	Boeing 757-300/RB211-535E4B	Jet	2	Large	Commercial	275 000	224 000	5 651	43 100	3	RR535E	CNT (lb)	203	103	Wing
757PW	Boeing 757-200/PW2037	Jet	2	Large	Commercial	255 000	210 000	4 790	38 300	3	PW2037	CNT (lb)	203	103	Wing

ACFTID	Description	Engine Type	Numb of Engines	Weight Class	Owner Category	MGTOW (lb)	MCLW (lb)	Max Landing Dist (ft)	Max Sea Level Static Thrust (lb)	Noise Chapter	NPD_ID	Power Parameter	Approach Spectral Class ID	Departure Spectral Class ID	Lateral Directivity Identifier
757RR	Boeing 757-200/RB211-535E4	Jet	2	Large	Commercial	255 000	210 000	4 640	40 100	3	RR535E	CNT (lb)	203	103	Wing
767300	Boeing 767-300/PW4060	Jet	2	Heavy	Commercial	407 000	320 000	4 710	60 000	3	2CF680	CNT (lb)	203	103	Wing
767400	Boeing 767-400ER/CF6-80C2B(f)	Jet	2	Heavy	Commercial	450 000	340 000	6 000	58 685	3	CF680C	CNT (lb)	205	102	Wing
767CF6	Boeing 767-200/CF6-80A	Jet	2	Heavy	Commercial	315 500	270 000	4 700	48 000	3	2CF680	CNT (lb)	203	103	Wing
767T19	Boeing 767-200/JT9D-7R4D	Jet	2	Heavy	Commercial	351 000	270 000	4 744	48 000	3	2CF680	CNT (lb)	203	103	Wing
777200	Boeing 777-200/GE90-76B	Jet	2	Heavy	Commercial	656 000	470 000	4 450	90 000	3	GE90	CNT (lb)	205	105	Wing
777300	Boeing 777-300/Trent 892	Jet	2	Heavy	Commercial	660 000	524 000	6 012	77 000	0	TRENT8	CNT (lb)	203	105	Wing
7773ER	Boeing 777-300ER/GE90-115B-EIS	Jet	2	Heavy	Commercial	775 000	554 000	5 805	115 000	3	GE9015	CNT (lb)	204	107	Wing
7878R	Boeing 787-8/T1000-C/01 Family Plan Cert	Jet	2	Heavy	Commercial	502 500	380 000	5 090	70 000	4	TIKBP	CNT (lb)	205	103	Wing
A300-622R	Airbus A300-622R/PW4158	Jet	2	Heavy	Commercial	378 533	308 647	4 735	58 000	3	PW4158	CNT (lb)	202	103	Wing
A300B4-203	Airbus A300B4-200/CF6-50C2	Jet	2	Heavy	Commercial	364 000	295 000	5 367	52 500	3	2CF650	CNT (lb)	203	103	Wing
A310-304	Airbus A310-304/GE CF6-80C2A2	Jet	2	Heavy	Commercial	346 126	273 373	4 682	53 500	3	A310	CNT (lb)	204	103	Wing
A319-131	Airbus A319-131/V2522-A5	Jet	2	Large	Commercial	166 449	137 789	4 364	22 000	3	V2522A	CNT (lb)	205	103	Wing

ACFTID	Description	Engine Type	Numb of Engines	Weight Class	Owner Category	MGTOW (lb)	MCLW (lb)	Max Landing Dist. (ft)	Max Sea Level Static Thrust (lb)	Noise Chapter	NPD_ID	Power Parameter	Approach Spectral Class ID	Departure Spectral Class ID	Lateral Directivity Identifier
A320-211	Airbus A320-211/CFM56-5A1	Jet	2	Large	Commercial	169 756	142 198	4 733	25 000	3	CFM565	CNT (lb)	202	103	Wing
A320-232	Airbus A320-232/V2527-A5	Jet	2	Large	Commercial	169 756	145 505	4 917	26 500	3	V2527A	CNT (lb)	205	103	Wing
A321-232	Airbus A321-232/AE V2530-A5	Jet	2	Large	Commercial	196 211	166 449	5 587	30 000	3	V2530	CNT (lb)	202	103	Wing
A330-301	Airbus A330-301/GE CF6-80 E1A2	Jet	2	Heavy	Commercial	478 400	383 604	5 966	67 500	3	CF680E	CNT (lb)	202	102	Wing
A330-343	Airbus A330-343/RR Trent 772B	Jet	2	Heavy	Commercial	513 677	412 264	5 512	71 100	3	TRENT7	CNT (lb)	205	102	Wing
A340-211	Airbus A340-211/CFM56-5C2	Jet	4	Heavy	Commercial	573 200	399 036	5 900	31 200	3	CF565C	CNT (lb)	206	107	Wing
A340-642	Airbus A340-642/RR Trent 556	Jet	4	Heavy	Commercial	804 687	564 383	6 919	56 000	4	TRENT5	CNT (lb)	205	102	Wing
A380-841	Airbus A380-841/RR Trent 970	Jet	4	Heavy	Commercial	1 254 430	862 007	6 752	70 000	4	TRENT9	CNT (lb)	205	105	Wing
A380-861	Airbus A380-861/EA GP7270	Jet	4	Heavy	Commercial	1 254 430	862 007	6 837	70 000	4	GP7270	CNT (lb)	206	105	Wing
BAC111	BAC 111/SPEY MK511-14	Jet	2	Large	Commercial	89 600	82 000	4 449	11 400	2	2JT8D	CNT (lb)	201	101	Fuselage
BAE146	BAe 146-200/ALF502R-5	Jet	4	Large	Commercial	93 000	81 000	3 770	6 970	3	AL502R	CNT (lb)	206	108	Wing
BAE300	BAe 146-300/ALF502R-5	Jet	4	Large	Commercial	97 500	84 500	3 960	6 970	3	AL502R	CNT (lb)	206	108	Wing
BEC58P	Raytheon BARON 58P/TS10-520-L	Piston	2	Small	General Aviation	6 100	6 100	2 733	779	0	TSIO52	CNT (% of Max Static Thrust)	215	109	Prop

ACFTID	Description	Engine Type	Numb of Engines	Weight Class	Owner Category	MCTOW (lb)	MCLW (lb)	Max Landing Dist (ft)	Max Sea Level Static Thrust (lb)	Noise Chapter	NPD_ID	Power Parameter	Approach Spectral Class ID	Departure Spectral Class ID	Lateral Directivity Identifier
CIT3	Cessna Citation III/TFE731-3-100S	Jet	2	Large	General Aviation	20 000	17 000	2 770	3 650	3	TF7313	CNT (lb)	216	113	Fuselage
CL600	Canadair CL-600/ALF502L	Jet	2	Large	General Aviation	36 000	33 000	3 300	7 500	3	AL502L	CNT (lb)	216	113	Fuselage
CL601	Canadair CL-601/CF34-3A	Jet	2	Large	General Aviation	43 100	36 000	3 550	9 220	3	CF34	CNT (lb)	216	113	Fuselage
CNA172	Cessna 172R/Lycoming IO-360-L2A	Piston	1	Small	General Aviation	2 450	2 450	1 695	436	0	IO360L	CNT (% of Max Static Thrust)	215	109	Prop
CNA182	Cessna 182H/Continental O-470-R	Piston	1	Small	General Aviation	2 800	2 800	1 544	965	2	O470R	CNT (lb)	215	113	Prop
CNA206	Cessna 206H/Lycoming IO-540-AC	Piston	1	Small	General Aviation	3 600	3 600	1 880	798	0	IO540	Other (RPM)	215	109	Prop
CNA208	Cessna 208/PT6A-114	Turbo-prop	1	Small	General Aviation	8 750	8 500	1 740	2 300	3	PT6-A114	CNT (lb)	210	109	Prop
CNA20T	Cessna T206H/Lycoming TIO-540-A)1A	Piston	1	Small	General Aviation	3 600	3 600	1 880	825	0	TIO540	Other (RPM)	215	109	Prop
CNA441	Cessna CONQUEST II /TPE331-8	Turbo-prop	2	Small	Commercial	9 900	9 400	1 939	1 535	0	TPE331	CNT (% of Max Static Thrust)	210	111	Prop
CNA500	Cessna Citation II/TT15D-4	Jet	2	Large	General Aviation	14 700	14 000	3 050	2 500	3	JT15D1	CNT (lb)	216	113	Fuselage
CNA510	Cessna Mustang Model 510/PW615F	Jet	2	Small	Commercial	8 645	7 200	3 010	1 466	0	PW615F	CNT (lb)	203	113	Fuselage
CNA525C	Cessna Citation CJ4 525C /FJ44-4A	Jet	2	Small	Commercial	16 950	15 500	3 010	3 600	4	FJ44-4	CNT (lb)	235	136	Fuselage

ACFTID	Description	Engine Type	Numb of Engines	Weight Class	Owner Category	MGTOW (lb)	MCLW (lb)	Max Landing Dist (ft)	Max Sea Level Static Thrust (lb)	Noise Chapter	NPD_ID	Power Parameter	Approach Spectral Class ID	Departure Spectral Class ID	Lateral Directivity Identifier
CNA55B	Cessna 550 Citation Bravo/PW530A	Jet	2	Large	General Aviation	14 800	13 500	3 010	2 863	0	PW530A	CNT (lb)	203	113	Fuselage
CNA560E	Cessna Citation Encore 560/PW535A	Jet	2	Small	Commercial	16 300	13 680	3 000	3 313	3	2PW535	CNT (lb)	238	138	Fuselage
CNA560U	Cessna Citation Ultra 560/JT15D-5D	Jet	2	Small	Commercial	16 300	13 680	2 700	3 029	3	2J155D	CNT (lb)	237	113	Fuselage
CNA560XL	Cessna Citation Excel 560/PW545A	Jet	2	Small	Commercial	20 000	16 830	3 000	3 824	3	PW545A	CNT (lb)	238	137	Fuselage
CNA680	Cessna Citation Sovereign 680/PW306C	Jet	2	Small	Commercial	30 000	24 390	3 010	5 749	3	PW306C	CNT (lb)	236	136	Fuselage
CNA750	Cessna Citation X/Rolls Royce Allison AE3007C	Jet	2	Large	General Aviation	35 700	31 800	3 500	6 407	3	AE300C	CNT (lb)	202	105	Fuselage
CONCRD	Concorde/OLY593	Jet	4	Heavy	Commercial	400 000	245 000	10 600	38 100	0	OLY593	CNT (lb)	206	106	Wing
CRJ9-ER	Bombardier CRJ-600-2D15/CL-600-2D24/CF34-8C5	Jet	2	Large	Commercial	82 500	73 500	5 779	13 525	3	CF348-C5	CNT (lb)	216	113	Fuselage
CRJ9-LR	Bombardier CRJ-600-2D15/CL-600-2D24/CF34-8C5	Jet	2	Large	Commercial	84 500	75 100	5 680	13 525	3	CF348-C5	CNT (lb)	216	113	Fuselage
CVR580	Convair CV-580/ALL 501-D15	Turbo-prop	2	Large	Commercial	58 000	52 000	4 256	8 100	0	501D13	CNT (% of Max Static Thrust)	214	112	Prop
DC1010	McDonnell Douglas DC10-10/CF6-6D	Jet	3	Heavy	Commercial	455 000	363 000	5 820	40 000	3	CF66D	CNT (lb)	203	101	Wing
DC1030	McDonnell Douglas DC10-30/CF6-50C2	Jet	3	Heavy	Commercial	572 000	403 000	5 418	53 200	3	CF66D	CNT (lb)	203	101	Wing

ACFTID	Description	Engine Type	Numb of Engines	Weight Class	Owner Category	MCTOW (lb)	MCLW (lb)	Max Landing Dist (ft)	Max Sea Level Static Thrust (lb)	Noise Chapter	NPD_ID	Power Parameter	Approach Spectral Class ID	Departure Spectral Class ID	Lateral Directivity Identifier
DC1040	McDonnell Douglas DC10-40/JT9D-20	Jet	3	Heavy	Commercial	555 000	403 000	6 020	49 400	3	CF66D	CNT (lb)	203	101	Wing
DC3	Douglas DC-3/R1820-86	Piston	2	Large	Commercial	28 000	24 500	2 222	3 120	0	2R2800	CNT (% of Max Static Thrust)	213	110	Prop
DC6	Douglas DC-6/R2800-CB17	Piston	4	Large	Commercial	106 000	95 000	3 010	4 180	0	4R2800	CNT (% of Max Static Thrust)	213	110	Prop
DC820	Douglas DC-8-20/JT4A	Jet	4	Heavy	Commercial	317 600	194 400	6 527	11 850	1	JT4A	CNT (lb)	208	107	Wing
DC850	Douglas DC-8-50/JT3D-3B	Jet	4	Heavy	Commercial	325 000	240 000	5 400	18 000	1	JT3D	CNT (lb)	208	107	Wing
DC860	Douglas DC-8-60/JT3D-7	Jet	4	Heavy	Commercial	355 000	275 000	5 310	19 000	1	JT3D	CNT (lb)	208	107	Wing
DC870	Douglas DC-8-70/CFM56-2C-5	Jet	4	Heavy	Commercial	355 000	258 000	6 500	22 000	3	CFM562	CNT (lb)	206	106	Wing
DC8QN	Douglas DC-8-60/JT8D-7QN	Jet	4	Heavy	Commercial	355 000	275 000	5 310	19 000	2	JT3DQ	CNT (lb)	208	106	Wing
DC910	McDonnell Douglas DC-9-10/JT8D-7	Jet	2	Large	Commercial	90 700	81 700	5 030	14 000	1	2JT8D	CNT (lb)	201	101	Fuselage
DC930	McDonnell Douglas DC-9-30/JT8D-9	Jet	2	Large	Commercial	114 000	102 000	4 680	14 500	1	2JT8D	CNT (lb)	201	101	Fuselage
DC931W	McDonnell Douglas DC-9-30/JT8D-9 w/ ABS Lightweight hushkit	Jet	2	Large	Commercial	114 000	102 000	4 680	14 500	3	2JT8DL	CNT (lb)	201	101	Fuselage
DC950	McDonnell Douglas DC-9-50/JT8D-17	Jet	2	Large	Commercial	121 000	110 000	4 880	16 000	2	2JT8DQ	CNT (lb)	201	101	Fuselage

ACFTID	Description	Engine type	Numb of Engines	Weight Class	Owner Category	MGTOW (lb)	MCLW (lb)	Max Landing Dist (ft)	Max Sea Level Static Thrust (lb)	Noise Chapter	NPD_ID	Power Parameter	Approach Spectral Class ID	Departure Spectral Class ID	Lateral Directivity Identifier
DC95HW	McDonnell Douglas DC-9-50/PT8D17 w/ ABS Heavyweight hushkit	Jet	2	Large	Commercial	121 000	110 000	4 880	16 000	3	2JT8DH	CNT (lb)	201	101	Fuselage
DC9Q7	McDonnell Douglas DC-9-10/PT8D-7QN	Jet	2	Large	Commercial	90 700	81 700	5 030	14 000	2	2JT8DQ	CNT (lb)	201	101	Fuselage
DC9Q9	McDonnell Douglas DC-9-30/PT8D-9QN	Jet	2	Large	Commercial	114 000	102 000	4 680	14 500	2	2JT8DQ	CNT (lb)	201	101	Fuselage
DHC6	De Havilland DASH 6/PT6A-27	Turbo-prop	2	Small	Commercial	12 500	12 300	1 500	2 000	0	PT6A27	CNT (% of Max Static Thrust)	210	109	Prop
DHC6QP	De Havilland DASH 6/PT6A-27 Raisbeck Quiet PropMod	Turbo-prop	2	Small	Commercial	12 500	12 300	1 500	2 000	0	RAISQP	CNT (% of Max Static Thrust)	210	109	Prop
DHC7	De Havilland DASH 7/PT6A-50	Turbo-prop	4	Large	Commercial	41 000	39 000	2 150	2 850	3	PT6A50	CNT (% of Max Static Thrust)	213	112	Prop
DHC8	Bombardier de Havilland DASH 8-100/PW121	Turbo-prop	2	Large	Commercial	34 500	33 900	3 000	4 750	3	PW120	CNT (% of Max Static Thrust)	213	112	Prop
DHC830	Bombardier de Havilland DASH 8-300/PW123	Turbo-prop	2	Large	Commercial	43 000	42 000	3 500	4 918	3	PW120	CNT (% of Max Static Thrust)	213	112	Prop
DO228	Dornier 228-202/TPE 311-5	Turbo-prop	2	Large	Commercial	13 669	13 448	2 375	2 240	3	TPE331-5	CNT (lb)	216	110	Prop
DO328	Dornier 328-100/PW119C	Turbo-prop	2	Large	Commercial	30 843	29 167	3 825	6 745	3	PW119C	CNT (lb)	214	109	Prop

ACFTID	Description	Engine Type	Numb of Engines	Weight Class	Owner Category	MGTOW (lb)	MGIW (lb)	Max Landing Dist (ft)	Max Sea Level Static Thrust (lb)	Noise Chapter	NPD_ID	Power Parameter	Approach Spectral Class ID	Departure Spectral Class ID	Lateral Directivity Identifier
ECLIPS-E500	Eclipse 500/PW610F	Jet	2	Small	General Aviation	6 000	5 600	2 389	1 031	3	PW610F	CNT (lb)	201	103	Fuselage
EMB120	Embraer 120 ER/Pratt & Whitney PW118	Turbo-prop	2	Large	Commercial	26 433	25 794	5 571	4 000	3	EPW118	CNT (lb)	213	109	Prop
EMB145	Embraer 145 ER/Allison AE3007	Jet	2	Large	Commercial	45 420	41 230	4 232	7 500	3	AE3007	CNT (lb)	216	113	Fuselage
EMB14L	Embraer 145 LR/Allison AE3007A1	Jet	2	Large	Commercial	48 500	42 550	4 232	7 500	3	AE3007	CNT (lb)	216	113	Fuselage
EMB170	Embraer ERJ170-100	Jet	2	Large	Commercial	82 012	72 312	4 029	13 800	3	CF348E	CNT (lb)	216	113	Wing
EMB175	Embraer ERJ170-200	Jet	2	Large	Commercial	85 517	74 957	4 130	13 800	3	CF348E	CNT (lb)	216	113	Wing
EMB190	Embraer ERJ190-100	Jet	2	Large	Commercial	114 199	97 003	4 081	18 500	3	CF3410E	CNT (lb)	205	105	Wing
EMB195	Embraer ERJ190-200	Jet	2	Large	Commercial	115 280	100 972	4 183	18 500	3	CF3410E	CNT (lb)	205	105	Wing
F10062	Fokker 100/TAY 620-15	Jet	2	Large	Commercial	95 000	85 500	4 560	13 900	3	TAY620	CNT (lb)	201	101	Fuselage
F10065	Fokker 100/TAY 650-15	Jet	2	Large	Commercial	98 000	88 000	4 704	15 100	3	TAY650	CNT (lb)	201	101	Fuselage
F28MK2	Fokker F-28-2000/ RB183MK555	Jet	2	Large	Commercial	65 000	59 000	3 540	9 850	2	RB183	CNT (lb)	216	104	Fuselage
F28MK4	Fokker F-28-4000/ RB183MK555	Jet	2	Large	Commercial	73 000	64 000	3 546	9 900	2	RB183P	CNT (lb)	216	104	Fuselage
FAL20	Dassault FALCON 20/ CF700-2D-2	Jet	2	Large	General Aviation	28 700	27 300	2 490	4 500	2	CF700	CNT (lb)	203	113	Fuselage

ACFTID	Description	Engine Type	Numb of Engines	Weight Class	Owner Category	MGTOW (lb)	MCLW (lb)	Max Landing Dist (ft)	Max Sea Level Static Thrust (lb)	Noise Chapter	NPD_ID	Power Parameter	Approach Spectral Class ID	Departure Spectral Class ID	Lateral Directivity Identifier
GII	Gulfstream GII/SPEY 511-8	Jet	2	Large	General Aviation	64 800	58 500	3 200	11 400	2	SPEYHK	CNT (lb)	216	104	Fuselage
GIIB	Gulfstream GIIB/GIIB/SPEY 511-8	Jet	2	Large	General Aviation	69 700	58 500	3 250	11 400	2	SPEYHK	CNT (lb)	216	104	Fuselage
GIV	Gulfstream GIV-SP/TAY 611-8	Jet	2	Large	General Aviation	74 600	66 000	3 190	13 850	3	TAYGIV	CNT (lb)	203	113	Fuselage
GV	Gulfstream GV/BR 710	Jet	2	Large	General Aviation	90 500	75 300	2 760	14 750	3	BR710	CNT (lb)	205	105	Fuselage
HS748A	Hawker Siddeley HS-748/DART MK532-2	Turbo-prop	2	Large	Commercial	46 500	43 000	3 360	5 150	2	RDA532	CNT (% of Max Static Thrust)	212	110	Prop
IA1125	IAI-1125 ASTRA/TFE731-3A	Jet	2	Large	General Aviation	23 500	20 700	3 689	3 700	3	TF7313	CNT (lb)	216	113	Fuselage
L1011	Lockheed Martin L-1011/RB211-22B	Jet	3	Heavy	Commercial	430 000	358 000	5 693	42 000	3	RB2112	CNT (lb)	203	101	Wing
L10115	Lockheed Martin L-1011-500/RB211-224B	Jet	3	Heavy	Commercial	510 000	368 000	6 800	50 000	3	RB2112	CNT (lb)	203	101	Wing
L188	Lockheed L-188C/ALL 501-D13	Turbo-prop	4	Large	Commercial	116 000	98 100	4 960	8 000	0	T56A7	CNT (% of Max Static Thrust)	214	112	Prop
LEAR25	Learjet 25/CJ610-8	Jet	2	Large	General Aviation	15 000	13 500	2 620	2 950	2	CJ610	CNT (lb)	202	113	Fuselage
LEAR35	Learjet 36/TFE731-2	Jet	2	Large	General Aviation	18 300	15 300	3 076	3 500	3	TF7312	CNT (lb)	216	113	Fuselage
MD11GE	McDonnell Douglas MD-11/CF6-80C2D1F	Jet	3	Heavy	Commercial	682 400	433 300	5 131	61 500	3	2CF68D	CNT (lb)	203	103	Wing
MD11PW	McDonnell Douglas MD-11/PW 4460	Jet	3	Heavy	Commercial	682 400	433 300	4 681	60 000	3	PW4460	CNT (lb)	203	103	Wing

ACFTID	Description	Engine Type	Numb of Engines	Weight Class	Owner Category	MGTOW (lb)	MGLW (lb)	Max Landing Dist (ft)	Max Sea Level Static Thrust (lb)	Noise Chapter	NPD_ID	Power Parameter	Approach Spectral Class ID	Departure Spectral Class ID	Lateral Directivity Identifier
MD81	McDonnell Douglas MD-81/JT8D-209	Jet	2	Large	Commercial	140 000	128 000	4 860	19 300	3	2JT8D2	CNT (lb)	204	104	Fuselage
MD82	McDonnell Douglas MD-82/JT8D-217A	Jet	2	Large	Commercial	149 500	130 000	4 920	20 900	3	2JT8D2	CNT (lb)	204	104	Fuselage
MD83	McDonnell Douglas MD-83/JT8D-219	Jet	2	Large	Commercial	160 000	139 500	5 200	21 700	3	2JT8D2	CNT (lb)	204	104	Fuselage
MD9025	McDonnell Douglas MD-90/V2525-D5	Jet	2	Large	Commercial	156 000	142 000	3 000	25 000	3	V2525	CNT (lb)	205	105	Fuselage
MD9028	McDonnell Douglas MD-90/V2528-D5	Jet	2	Large	Commercial	156 000	142 000	3 000	28 000	3	V2525	CNT (lb)	205	105	Fuselage
MU3001	Mitsubishi MU300-10 Diamond II/JT15D-5	Jet	2	Large	General Aviation	14 100	13 200	2 800	2 500	3	JT15D5	CNT (lb)	203	113	Fuselage
PA28	Piper Warrior PA-28-161/O-320-D3G	Piston	1	Small	General Aviation	2 325	2 325	1 695	400	0	O320D3	Other (RPM)	213	113	Prop
PA30	Piper Twin Comanche PA-30/IO-320-B1A	Piston	2	Small	General Aviation	3 600	3 600	1 654	777	0	IO320B	CNT (lb)	213	113	Prop
PA31	Piper Navajo Chief/PA-31-350/JTO-5	Piston	2	Small	General Aviation	7 000	7 000	1 850	1 481	0	TIO542	Other (RPM)	213	109	Prop
PA42	Piper PA-42/PT6A-41	Turbo-prop	2	Small	General Aviation	11 200	10 350	3 300	1 800	3	PT6A41	CNT (lb)	213	109	Prop
SABR80	NA Sabreliner 80	Jet	2	Large	General Aviation	33 720	27 290	2 490	3 962	2	CF700	CNT (lb)	203	113	Fuselage
SD330	Short SD3-30/PT6A-45AR	Turbo-prop	2	Large	Commercial	22 900	22 600	3 650	2 670	3	PT6A45	CNT (% of Max Static Thrust)	211	109	Prop
SF340	Saab SF340B/CT7-9B	Turbo-prop	2	Large	Commercial	27 300	26 500	3 470	4 067	3	CT75	CNT (% of Max Static Thrust)	211	110	Prop

Table I-3

Default approach procedural steps

ACFTID	Profile_ID	Step number	Step type	Flap_ID	Start Altitude (ft)	Start CAS (kt)	Descent Angle (deg)	Touchdown Roll (ft)	Distance (ft)	Start Thrust (% Max thrust)
1900D	DEFAULT	1	Descend	ZERO-A	6 000,0	160,0	3,0			
1900D	DEFAULT	2	Descend	ZERO-A	3 000,0	160,0	3,0			
1900D	DEFAULT	3	Descend	ZERO-A	1 500,0	146,0	3,0			
1900D	DEFAULT	4	Descend	35-A	1 000,0	118,0	3,0			
1900D	DEFAULT	5	Land	35-A				57,2		
1900D	DEFAULT	6	Decelerate			84,0			515,2	40,0
1900D	DEFAULT	7	Decelerate			10,0			0,0	10,0
707320	DEFAULT	1	Descend	ZERO	6 000,0	250,0	3,0			
707320	DEFAULT	2	Descend	14	3 000,0	160,0	3,0			
707320	DEFAULT	3	Descend	D-25	1 500,0	145,0	3,0			
707320	DEFAULT	4	Descend	D-40	1 000,0	131,6	3,0			
707320	DEFAULT	5	Land	D-40				410,6		
707320	DEFAULT	6	Decelerate			124,9			3 695,4	40,0
707320	DEFAULT	7	Decelerate			30,0			0,0	10,0
707QN	DEFAULT	1	Descend	ZERO	6 000,0	250,0	3,0			
707QN	DEFAULT	2	Descend	14	3 000,0	160,0	3,0			
707QN	DEFAULT	3	Descend	D-25	1 500,0	145,0	3,0			
707QN	DEFAULT	4	Descend	D-40	1 000,0	131,6	3,0			
707QN	DEFAULT	5	Land	D-40				410,6		
707QN	DEFAULT	6	Decelerate			124,9			3 695,4	40,0
707QN	DEFAULT	7	Decelerate			30,0			0,0	10,0
717200	DEFAULT	1	Descend	A_0U	6 000,0	250,0	3,0			

ACFTID	Profile_ID	Step number	Step type	Flap_ID	Start Altitude (ft)	Start CAS (kt)	Descent Angle (deg)	Touchdown Roll (ft)	Distance (ft)	Start Thrust (% Max thrust)
717200	DEFAULT	2	Descend	A_18U	3 000,0	190,0	3,0			
717200	DEFAULT	3	Descend	A_18D	1 500,0	160,0	3,0			
717200	DEFAULT	4	Descend	A_40D	1 000,0	140,0	3,0			
717200	DEFAULT	5	Land	A_40D				318,6		
717200	DEFAULT	6	Decelerate			130,0			2 867,4	40,0
717200	DEFAULT	7	Decelerate			30,0			0,0	8,6
720B	DEFAULT	1	Descend	ZERO	6 000,0	250,0	3,0			
720B	DEFAULT	2	Descend	20	3 000,0	160,0	3,0			
720B	DEFAULT	3	Descend	U-30	1 500,0	149,0	3,0			
720B	DEFAULT	4	Descend	D-30	1 000,0	139,0	3,0			
720B	DEFAULT	5	Land	D-30				419,1		
720B	DEFAULT	6	Decelerate			131,9			3 771,9	40,0
720B	DEFAULT	7	Decelerate			30,0			0,0	10,0
727100	DEFAULT	1	Descend	ZERO	6 000,0	250,0	3,0			
727100	DEFAULT	2	Descend	5	3 000,0	160,0	3,0			
727100	DEFAULT	3	Descend	D-25	1 500,0	125,5	3,0			
727100	DEFAULT	4	Descend	D-30	1 000,0	123,2	3,0			
727100	DEFAULT	5	Land	D-30				342,6		
727100	DEFAULT	6	Decelerate			116,8			3 083,4	40,0
727100	DEFAULT	7	Decelerate			30,0			0,0	10,0
727D15	DEFAULT	1	Descend	ZERO	6 000,0	250,0	3,0			
727D15	DEFAULT	2	Descend	5	3 000,0	160,0	3,0			

ACFTID	Profile_ID	Step number	Step type	Flap_ID	Start Altitude (ft)	Start CAS (kt)	Descent Angle (deg)	Touchdown Roll (ft)	Distance (ft)	Start Thrust (% Max thrust)
727D15	DEFAULT	3	Descend	D-25	1 500,0	149,6	3,0			
727D15	DEFAULT	4	Descend	D-30	1 000,0	147,6	3,0			
727D15	DEFAULT	5	Land	D-30				347,6		
727D15	DEFAULT	6	Decelerate			140,0			3 128,4	40,0
727D15	DEFAULT	7	Decelerate			30,0			0,0	10,0
727D17	DEFAULT	1	Descend	ZERO	6 000,0	250,0	3,0			
727D17	DEFAULT	2	Descend	5	3 000,0	160,0	3,0			
727D17	DEFAULT	3	Descend	D-25	1 500,0	149,6	3,0			
727D17	DEFAULT	4	Descend	D-30	1 000,0	147,6	3,0			
727D17	DEFAULT	5	Land	D-30				394,6		
727D17	DEFAULT	6	Decelerate			140,0			3 551,4	40,0
727D17	DEFAULT	7	Decelerate			30,0			0,0	10,0
727EM1	DEFAULT	1	Descend	ZERO	6 000,0	250,0	3,0			
727EM1	DEFAULT	2	Descend	5	3 000,0	160,0	3,0			
727EM1	DEFAULT	3	Descend	D-25	1 500,0	125,5	3,0			
727EM1	DEFAULT	4	Descend	D-30	1 000,0	123,2	3,0			
727EM1	DEFAULT	5	Land	D-30				342,6		
727EM1	DEFAULT	6	Decelerate			116,8			3 083,4	40,0
727EM1	DEFAULT	7	Decelerate			30,0			0,0	10,0
727EM2	DEFAULT	1	Descend	ZERO	6 000,0	250,0	3,0			
727EM2	DEFAULT	2	Descend	5	3 000,0	160,0	3,0			
727EM2	DEFAULT	3	Descend	D-25	1 500,0	149,6	3,0			

ACFTID	Profile_ID	Step number	Step type	Flap_ID	Start Altitude (ft)	Start CAS (kt)	Descent Angle (deg)	Touchdown Roll (ft)	Distance (ft)	Start Thrust (% Max thrust)
727EM2	DEFAULT	4	Descend	D-30	1 000,0	147,6	3,0			
727EM2	DEFAULT	5	Land	D-30				347,6		
727EM2	DEFAULT	6	Decelerate			140,0			3 128,4	40,0
727EM2	DEFAULT	7	Decelerate			30,0			0,0	10,0
727Q15	DEFAULT	1	Descend	ZERO	6 000,0	250,0	3,0			
727Q15	DEFAULT	2	Descend	5	3 000,0	160,0	3,0			
727Q15	DEFAULT	3	Descend	D-25	1 500,0	149,6	3,0			
727Q15	DEFAULT	4	Descend	D-30	1 000,0	147,6	3,0			
727Q15	DEFAULT	5	Land	D-30				347,6		
727Q15	DEFAULT	6	Decelerate			140,0			3 128,4	40,0
727Q15	DEFAULT	7	Decelerate			30,0			0,0	10,0
727Q7	DEFAULT	1	Descend	ZERO	6 000,0	250,0	3,0			
727Q7	DEFAULT	2	Descend	5	3 000,0	160,0	3,0			
727Q7	DEFAULT	3	Descend	D-25	1 500,0	125,5	3,0			
727Q7	DEFAULT	4	Descend	D-30	1 000,0	123,2	3,0			
727Q7	DEFAULT	5	Land	D-30				342,6		
727Q7	DEFAULT	6	Decelerate			116,8			3 083,4	40,0
727Q7	DEFAULT	7	Decelerate			30,0			0,0	10,0
727Q9	DEFAULT	1	Descend	ZERO	6 000,0	250,0	3,0			
727Q9	DEFAULT	2	Descend	5	3 000,0	160,0	3,0			
727Q9	DEFAULT	3	Descend	D-25	1 500,0	145,4	3,0			
727Q9	DEFAULT	4	Descend	D-30	1 000,0	143,4	3,0			

ACFTID	Profile_ID	Step number	Step type	Flap_ID	Start Altitude (ft)	Start CAS (kt)	Descent Angle (deg)	Touchdown Roll (ft)	Distance (ft)	Start Thrust (% Max thrust)
727Q9	DEFAULT	5	Land	D-30				394,6		
727Q9	DEFAULT	6	Decelerate			136,0			3 551,4	40,0
727Q9	DEFAULT	7	Decelerate			30,0			0,0	10,0
727QF	DEFAULT	1	Descend	U-ZERO	6 000,0	250,0	3,0			
727QF	DEFAULT	2	Descend	U-05	3 000,0	160,0	3,0			
727QF	DEFAULT	3	Descend	D-15	1 500,0	150,0	3,0			
727QF	DEFAULT	4	Descend	D-30	1 000,0	131,0	3,0			
727QF	DEFAULT	5	Land	D-30				363,0		
727QF	DEFAULT	6	Decelerate			121,0			2 686,0	40,0
727QF	DEFAULT	7	Decelerate			60,0			0,0	10,0
737	DEFAULT	1	Descend	ZERO	6 000,0	250,0	3,0			
737	DEFAULT	2	Descend	5	3 000,0	170,0	3,0			
737	DEFAULT	3	Descend	D-25	1 500,0	134,5	3,0			
737	DEFAULT	4	Descend	D-30	1 000,0	131,5	3,0			
737	DEFAULT	5	Land	D-30				255,6		
737	DEFAULT	6	Decelerate			124,8			2 300,4	40,0
737	DEFAULT	7	Decelerate			30,0			0,0	10,0
737300	DEFAULT	1	Descend	ZERO	6 000,0	250,0	3,0			
737300	DEFAULT	2	Descend	5	3 000,0	170,0	3,0			
737300	DEFAULT	3	Descend	D-15	1 500,0	148,6	3,0			
737300	DEFAULT	4	Descend	D-30	1 000,0	139,0	3,0			
737300	DEFAULT	5	Land	D-30				316,8		

ACFTID	Profile_ID	Step number	Step type	Flap_ID	Start Altitude (ft)	Start CAS (kt)	Descent Angle (deg)	Touchdown Roll (ft)	Distance (ft)	Start Thrust (% Max thrust)
737300	DEFAULT	6	Decelerate			131,9			2 851,2	40,0
737300	DEFAULT	7	Decelerate			30,0			0,0	10,0
7373B2	DEFAULT	1	Descend	ZERO	6 000,0	250,0	3,0			
7373B2	DEFAULT	2	Descend	5	3 000,0	170,0	3,0			
7373B2	DEFAULT	3	Descend	D-15	1 500,0	148,6	3,0			
7373B2	DEFAULT	4	Descend	D-30	1 000,0	139,0	3,0			
7373B2	DEFAULT	5	Land	D-30				316,8		
7373B2	DEFAULT	6	Decelerate			131,9			2 851,2	40,0
7373B2	DEFAULT	7	Decelerate			30,0			0,0	10,0
737400	DEFAULT	1	Descend	ZERO	6 000,0	250,0	3,0			
737400	DEFAULT	2	Descend	5	3 000,0	170,0	3,0			
737400	DEFAULT	3	Descend	D-15	1 500,0	159,7	3,0			
737400	DEFAULT	4	Descend	D-30	1 000,0	144,9	3,0			
737400	DEFAULT	5	Land	D-30				360,2		
737400	DEFAULT	6	Decelerate			137,5			3 241,8	40,0
737400	DEFAULT	7	Decelerate			30,0			0,0	10,0
737500	DEFAULT	1	Descend	ZERO	6 000,0	250,0	3,0			
737500	DEFAULT	2	Descend	5	3 000,0	170,0	3,0			
737500	DEFAULT	3	Descend	D-15	1 500,0	143,4	3,0			
737500	DEFAULT	4	Descend	D-30	1 000,0	135,3	3,0			
737500	DEFAULT	5	Land	D-30				314,2		
737500	DEFAULT	6	Decelerate			128,4			2 827,8	40,0

ACFTID	Profile_ID	Step number	Step type	Flap_ID	Start Altitude (ft)	Start CAS (kt)	Descent Angle (deg)	Touchdown Roll (ft)	Distance (ft)	Start Thrust (% Max thrust)
737500	DEFAULT	7	Decelerate			30,0			0,0	10,0
737700	DEFAULT	1	Descend	T_ZERO	6 000,0	250,0	3,0			
737700	DEFAULT	2	Descend	T_5	3 000,0	171,0	3,0			
737700	DEFAULT	3	Descend	A_15	1 500,0	140,0	3,0			
737700	DEFAULT	4	Descend	A_40	1 000,0	133,0	3,0			
737700	DEFAULT	5	Land	A_40				304,7		
737700	DEFAULT	6	Decelerate			116,0			2 741,9	40,0
737700	DEFAULT	7	Decelerate			30,0			0,0	10,0
737D17	DEFAULT	1	Descend	ZERO	6 000,0	250,0	3,0			
737D17	DEFAULT	2	Descend	5	3 000,0	170,0	3,0			
737D17	DEFAULT	3	Descend	D-25	1 500,0	140,2	3,0			
737D17	DEFAULT	4	Descend	D-30	1 000,0	137,7	3,0			
737D17	DEFAULT	5	Land	D-30				286,6		
737D17	DEFAULT	6	Decelerate			130,7			2 579,4	40,0
737D17	DEFAULT	7	Decelerate			30,0			0,0	10,0
737N17	DEFAULT	1	Descend	ZERO	6 000,0	250,0	3,0			
737N17	DEFAULT	2	Descend	5	3 000,0	170,0	3,0			
737N17	DEFAULT	3	Descend	D-25	1 500,0	140,2	3,0			
737N17	DEFAULT	4	Descend	D-30	1 000,0	137,7	3,0			
737N17	DEFAULT	5	Land	D-30				286,6		
737N17	DEFAULT	6	Decelerate			130,7			2 579,4	40,0
737N17	DEFAULT	7	Decelerate			30,0			0,0	10,0

ACFTID	Profile_ID	Step number	Step type	Flap_ID	Start Altitude (ft)	Start CAS (kt)	Descent Angle (deg)	Touchdown Roll (ft)	Distance (ft)	Start Thrust (% Max thrust)
737N9	DEFAULT	1	Descend	ZERO	6 000,0	250,0	3,0			
737N9	DEFAULT	2	Descend	5	3 000,0	170,0	3,0			
737N9	DEFAULT	3	Descend	D-25	1 500,0	134,5	3,0			
737N9	DEFAULT	4	Descend	D-30	1 000,0	131,5	3,0			
737N9	DEFAULT	5	Land	D-30				255,6		
737N9	DEFAULT	6	Decelerate			124,8			2 300,4	40,0
737N9	DEFAULT	7	Decelerate			30,0			0,0	10,0
737QN	DEFAULT	1	Descend	ZERO	6 000,0	250,0	3,0			
737QN	DEFAULT	2	Descend	5	3 000,0	170,0	3,0			
737QN	DEFAULT	3	Descend	D-25	1 500,0	134,5	3,0			
737QN	DEFAULT	4	Descend	D-30	1 000,0	131,5	3,0			
737QN	DEFAULT	5	Land	D-30				255,6		
737QN	DEFAULT	6	Decelerate			124,8			2 300,4	40,0
737QN	DEFAULT	7	Decelerate			30,0			0,0	10,0
74710Q	DEFAULT	1	Descend	ZERO	6 000,0	250,0	3,0			
74710Q	DEFAULT	2	Descend	10	3 000,0	160,0	3,0			
74710Q	DEFAULT	3	Descend	D-20	1 500,0	155,0	3,0			
74710Q	DEFAULT	4	Descend	D-30	1 000,0	144,0	3,0			
74710Q	DEFAULT	5	Land	D-30				462,6		
74710Q	DEFAULT	6	Decelerate			136,6			4 163,4	10,0
74710Q	DEFAULT	7	Decelerate			30,0			0,0	10,0
747200	DEFAULT	1	Descend	ZERO	6 000,0	250,0	3,0			

ACFTID	Profile_ID	Step number	Step type	Flap_ID	Start Altitude (ft)	Start CAS (kt)	Descent Angle (deg)	Touchdown Roll (ft)	Distance (ft)	Start Thrust (% Max thrust)
747200	DEFAULT	2	Descend	10	3 000,0	160,0	3,0			
747200	DEFAULT	3	Descend	D-20	1 500,0	155,0	3,0			
747200	DEFAULT	4	Descend	D-30	1 000,0	144,0	3,0			
747200	DEFAULT	5	Land	D-30				462,6		
747200	DEFAULT	6	Decelerate			136,6			4 163,4	10,0
747200	DEFAULT	7	Decelerate			30,0			0,0	10,0
74720A	DEFAULT	1	Descend	ZERO	6 000,0	250,0	3,0			
74720A	DEFAULT	2	Descend	10	3 000,0	163,7	3,0			
74720A	DEFAULT	3	Descend	D-25	1 500,0	150,0	3,0			
74720A	DEFAULT	4	Descend	D-30	1 000,0	143,7	3,0			
74720A	DEFAULT	5	Land	D-30				462,6		
74720A	DEFAULT	6	Decelerate			136,3			4 163,4	10,0
74720A	DEFAULT	7	Decelerate			30,0			0,0	10,0
74720B	DEFAULT	1	Descend	ZERO	6 000,0	250,0	3,0			
74720B	DEFAULT	2	Descend	10	3 000,0	171,9	3,0			
74720B	DEFAULT	3	Descend	D-25	1 500,0	158,5	3,0			
74720B	DEFAULT	4	Descend	D-30	1 000,0	151,9	3,0			
74720B	DEFAULT	5	Land	D-30				462,6		
74720B	DEFAULT	6	Decelerate			144,1			4 163,4	10,0
74720B	DEFAULT	7	Decelerate			30,0			0,0	10,0
747400	DEFAULT	1	Descend	5	6 000,0	250,0	3,0			
747400	DEFAULT	2	Descend	10	3 000,0	175,4	3,0			

ACFTID	Profile_ID	Step number	Step type	Flap_ID	Start Altitude (ft)	Start CAS (kt)	Descent Angle (deg)	Touchdown Roll (ft)	Distance (ft)	Start Thrust (% Max thrust)
747400	DEFAULT	3	Descend	D-25	1 500,0	161,4	3,0			
747400	DEFAULT	4	Descend	D-30	1 000,0	155,4	3,0			
747400	DEFAULT	5	Land	D-30				533,6		
747400	DEFAULT	6	Decelerate			147,5			4 802,4	10,0
747400	DEFAULT	7	Decelerate			30,0			0,0	10,0
7478	DEFAULT	1	Descend-Idle		6 000,0	278,8	3,0			
7478	DEFAULT	2	Level-Idle		3 000,0	279,5			30 000,0	
7478	DEFAULT	3	Level-Idle		3 000,0	218,3			10 000,0	
7478	DEFAULT	4	Level-Idle		3 000,0	186,1			3 050,0	
7478	DEFAULT	5	Level-Idle		3 000,0	174,6			4 500,0	
7478	DEFAULT	6	Level	F_10	3 000,0	162,3			2 069,0	
7478	DEFAULT	7	Descend	F_30	3 000,0	157,4	3,0			
7478	DEFAULT	8	Land	F_30				615,6		
7478	DEFAULT	9	Decelerate			150,4			5 540,4	10,0
7478	DEFAULT	10	Decelerate			30,0			0,0	10,0
747SP	DEFAULT	1	Descend	ZERO	6 000,0	250,0	3,0			
747SP	DEFAULT	2	Descend	10	3 000,0	160,0	3,0			
747SP	DEFAULT	3	Descend	D-20	1 500,0	141,5	3,0			
747SP	DEFAULT	4	Descend	D-30	1 000,0	132,4	3,0			
747SP	DEFAULT	5	Land	D-30				436,6		
747SP	DEFAULT	6	Decelerate			125,6			3 929,4	10,0
747SP	DEFAULT	7	Decelerate			30,0			0,0	10,0

ACFTID	Profile_ID	Step number	Step type	Flap_ID	Start Altitude (ft)	Start CAS (kt)	Descent Angle (deg)	Touchdown Roll (ft)	Distance (ft)	Start Thrust (% Max thrust)
757PW	DEFAULT	1	Descend	ZERO	6 000,0	250,0	3,0			
757PW	DEFAULT	2	Descend	5	3 000,0	160,0	3,0			
757PW	DEFAULT	3	Descend	D-25	1 500,0	136,5	3,0			
757PW	DEFAULT	4	Descend	D-30	1 000,0	134,2	3,0			
757PW	DEFAULT	5	Land	D-30				335,7		
757PW	DEFAULT	6	Decelerate			127,3			3 021,3	40,0
757PW	DEFAULT	7	Decelerate			30,0			0,0	10,0
757RR	DEFAULT	1	Descend	ZERO	6 000,0	250,0	3,0			
757RR	DEFAULT	2	Descend	5	3 000,0	160,0	3,0			
757RR	DEFAULT	3	Descend	D-25	1 500,0	136,7	3,0			
757RR	DEFAULT	4	Descend	D-30	1 000,0	134,7	3,0			
757RR	DEFAULT	5	Land	D-30				322,2		
757RR	DEFAULT	6	Decelerate			127,8			2 899,8	40,0
757RR	DEFAULT	7	Decelerate			30,0			0,0	10,0
767300	DEFAULT	1	Descend	ZERO	6 000,0	250,0	3,0			
767300	DEFAULT	2	Descend	5	3 000,0	167,0	3,0			
767300	DEFAULT	3	Descend	D-25	1 500,0	141,0	3,0			
767300	DEFAULT	4	Descend	D-30	1 000,0	137,1	3,0			
767300	DEFAULT	5	Land	D-30				328,5		
767300	DEFAULT	6	Decelerate			130,1			2 956,5	10,0
767300	DEFAULT	7	Decelerate			30,0			0,0	10,0
767CF6	DEFAULT	1	Descend	1	6 000,0	250,0	3,0			

ACFTID	Profile_ID	Step number	Step type	Flap_ID	Start Altitude (ft)	Start CAS (kt)	Descent Angle (deg)	Touchdown Roll (ft)	Distance (ft)	Start Thrust (% Max thrust)
767CF6	DEFAULT	2	Descend	5	3 000,0	168,5	3,0			
767CF6	DEFAULT	3	Descend	D-25	1 500,0	143,0	3,0			
767CF6	DEFAULT	4	Descend	D-30	1 000,0	138,5	3,0			
767CF6	DEFAULT	5	Land	D-30				327,6		
767CF6	DEFAULT	6	Decelerate			131,4			2 948,4	10,0
767CF6	DEFAULT	7	Decelerate			30,0			0,0	10,0
767JT9	DEFAULT	1	Descend	ZERO	6 000,0	250,0	3,0			
767JT9	DEFAULT	2	Descend	5	3 000,0	168,5	3,0			
767JT9	DEFAULT	3	Descend	D-25	1 500,0	143,0	3,0			
767JT9	DEFAULT	4	Descend	D-30	1 000,0	138,5	3,0			
767JT9	DEFAULT	5	Land	D-30				331,6		
767JT9	DEFAULT	6	Decelerate			131,4			2 984,4	10,0
767JT9	DEFAULT	7	Decelerate			30,0			0,0	10,0
7773ER	DEFAULT	1	Descend-Idle		6 000,0	249,9	3,0			
7773ER	DEFAULT	2	Level-Idle		3 000,0	249,9			20 776,0	
7773ER	DEFAULT	3	Level-Idle		3 000,0	210,6			10 088,0	
7773ER	DEFAULT	4	Level-Idle		3 000,0	185,4			5 926,0	
7773ER	DEFAULT	5	Descend-Idle		3 000,0	170,4	3,0			
7773ER	DEFAULT	6	Descend	F_30	2 700,0	147,8	3,0			
7773ER	DEFAULT	7	Land	F_30				427,1		
7773ER	DEFAULT	8	Decelerate			140,8			3 843,5	10,0
7773ER	DEFAULT	9	Decelerate			30,0			0,0	10,0

ACFTID	Profile_ID	Step number	Step type	Flap_ID	Start Altitude (ft)	Start CAS (kt)	Descent Angle (deg)	Touchdown Roll (ft)	Distance (ft)	Start Thrust (% Max thrust)
7878R	DEFAULT	1	Descend-Idle		6 000,0	249,0	3,0			
7878R	DEFAULT	2	Level-Idle		3 000,0	249,5			20 950,0	
7878R	DEFAULT	3	Level-Idle		3 000,0	214,3			10 000,0	
7878R	DEFAULT	4	Level-Idle		3 000,0	178,9			5 000,0	
7878R	DEFAULT	5	Descend-Idle		3 000,0	157,0	3,0			
7878R	DEFAULT	6	Descend	FLAP30	2 725,0	142,3	3,0			
7878R	DEFAULT	7	Land	FLAP30				362,7		
7878R	DEFAULT	8	Decelerate			135,3			3 264,3	10,0
7878R	DEFAULT	9	Decelerate			30,0			0,0	10,0
A 300-622R	DEFAULT	1	Descend-Idle		6 000,0	250,0	3,3			
A 300-622R	DEFAULT	2	Level-Idle		3 000,0	250,0			14 583,3	
A 300-622R	DEFAULT	3	Level-Idle		3 000,0	210,9			7 398,3	
A 300-622R	DEFAULT	4	Descend-Idle		3 000,0	185,1	3,0			
A 300-622R	DEFAULT	5	Descend-Idle		2 417,0	175,9	3,0			
A 300-622R	DEFAULT	6	Descend-Idle		1 818,0	149,0	3,0			
A 300-622R	DEFAULT	7	Descend	FULL_D	1 615,0	133,5	3,0			
A 300-622R	DEFAULT	8	Descend	FULL_D	50,0	133,5	3,0			
A 300-622R	DEFAULT	9	Land	FULL_D				305,3		
A 300-622R	DEFAULT	10	Decelerate			130,5			2 747,8	10,0
A 300-622R	DEFAULT	11	Decelerate			30,0			0,0	10,0
A 300B4-203	DEFAULT	1	Descend	ZERO	6 000,0	250,0	3,0			
A 300B4-203	DEFAULT	2	Descend	1	3 000,0	158,5	3,0			

ACFTID	Profile_ID	Step number	Step type	Flap_ID	Start Altitude (ft)	Start CAS (kt)	Descent Angle (deg)	Touchdown Roll (ft)	Distance (ft)	Start Thrust (% Max thrust)
A300B4-203	DEFAULT	3	Descend	D-15	1 500,0	148,5	3,0			
A300B4-203	DEFAULT	4	Descend	D-25	1 000,0	140,0	3,0			
A300B4-203	DEFAULT	5	Land	D-25				387,6		
A300B4-203	DEFAULT	6	Decelerate			132,8			3 488,4	40,0
A300B4-203	DEFAULT	7	Decelerate			30,0			0,0	10,0
A310-304	DEFAULT	1	Descend-Idle		6 000,0	250,0	3,2			
A310-304	DEFAULT	2	Level-Idle		3 000,0	250,0			14 609,6	
A310-304	DEFAULT	3	Level-Idle		3 000,0	211,6			8 736,9	
A310-304	DEFAULT	4	Descend-Idle		3 000,0	180,6	3,0			
A310-304	DEFAULT	5	Descend-Idle		2 551,0	169,3	3,0			
A310-304	DEFAULT	6	Descend-Idle		2 147,0	148,0	3,0			
A310-304	DEFAULT	7	Descend	FULL_D	2 000,0	134,6	3,0			
A310-304	DEFAULT	8	Descend	FULL_D	50,0	134,6	3,0			
A310-304	DEFAULT	9	Land	FULL_D				302,9		
A310-304	DEFAULT	10	Decelerate			131,6			2 726,6	10,0
A310-304	DEFAULT	11	Decelerate			30,0			0,0	10,0
A319-131	DEFAULT	1	Descend-Idle		6 000,0	250,0	3,1			
A319-131	DEFAULT	2	Level-Idle		3 000,0	250,0			19 940,9	
A319-131	DEFAULT	3	Level-Idle		3 000,0	197,5			4 813,0	
A319-131	DEFAULT	4	Descend-Idle		3 000,0	181,4	3,0			
A319-131	DEFAULT	5	Descend-Idle		2 610,0	167,7	3,0			
A319-131	DEFAULT	6	Descend-Idle		2 114,0	138,4	3,0			

ACFTID	Profile_ID	Step number	Step type	Flap_ID	Start Altitude (ft)	Start CAS (kt)	Descent Angle (deg)	Touchdown Roll (ft)	Distance (ft)	Start Thrust (% Max thrust)
A319-131	DEFAULT	7	Descend	FULL_D	1 971,0	125,3	3,0			
A319-131	DEFAULT	8	Descend	FULL_D	50,0	125,3	3,0			
A319-131	DEFAULT	9	Land	FULL_D				152,3		
A319-131	DEFAULT	10	Decelerate			122,3			1 370,6	40,0
A319-131	DEFAULT	11	Decelerate			30,0			0,0	10,0
A320-211	DEFAULT	1	Descend-Idle		6 000,0	250,0	3,5			
A320-211	DEFAULT	2	Level-Idle		3 000,0	250,0			16 811,0	
A320-211	DEFAULT	3	Level-Idle		3 000,0	201,1			5 547,9	
A320-211	DEFAULT	4	Descend-Idle		3 000,0	182,2	3,0			
A320-211	DEFAULT	5	Descend-Idle		2 614,0	173,7	3,0			
A320-211	DEFAULT	6	Descend-Idle		1 942,0	141,0	3,0			
A320-211	DEFAULT	7	Descend	FULL_D	1 823,0	132,6	3,0			
A320-211	DEFAULT	8	Descend	FULL_D	50,0	132,6	3,0			
A320-211	DEFAULT	9	Land	FULL_D				303,5		
A320-211	DEFAULT	10	Decelerate			129,6			2 731,6	40,0
A320-211	DEFAULT	11	Decelerate			30,0			0,0	10,0
A320-232	DEFAULT	1	Descend-Idle		6 000,0	250,0	2,8			
A320-232	DEFAULT	2	Level-Idle		3 000,0	250,0			20 003,3	
A320-232	DEFAULT	3	Level-Idle		3 000,0	198,7			4 629,3	
A320-232	DEFAULT	4	Descend-Idle		3 000,0	183,5	3,0			
A320-232	DEFAULT	5	Descend-Idle		2 613,0	172,8	3,0			
A320-232	DEFAULT	6	Descend-Idle		2 033,0	142,2	3,0			

ACFTID	Profile_ID	Step number	Step type	Flap_ID	Start Altitude (ft)	Start CAS (kt)	Descent Angle (deg)	Touchdown Roll (ft)	Distance (ft)	Start Thrust (% Max thrust)
A320-232	DEFAULT	7	Descend	FULL_D	1 819,0	133,8	3,0			
A320-232	DEFAULT	8	Descend	FULL_D	50,0	133,8	3,0			
A320-232	DEFAULT	9	Land	FULL_D				311,0		
A320-232	DEFAULT	10	Decelerate			130,8			2 799,4	40,0
A320-232	DEFAULT	11	Decelerate			30,0			0,0	10,0
A321-232	DEFAULT	1	Descend-Idle		6 000,0	250,0	3,1			
A321-232	DEFAULT	2	Level-Idle		3 000,0	250,0			14 717,8	
A321-232	DEFAULT	3	Level-Idle		3 000,0	211,2			6 135,2	
A321-232	DEFAULT	4	Descend-Idle		3 000,0	191,6	3,0			
A321-232	DEFAULT	5	Descend-Idle		2 530,0	175,2	3,0			
A321-232	DEFAULT	6	Descend-Idle		2 133,0	149,8	3,0			
A321-232	DEFAULT	7	Descend	FULL_D	2 003,0	138,5	3,0			
A321-232	DEFAULT	8	Descend	FULL_D	50,0	138,5	3,0			
A321-232	DEFAULT	9	Land	FULL_D				345,2		
A321-232	DEFAULT	10	Decelerate			135,5			3 106,8	40,0
A321-232	DEFAULT	11	Decelerate			30,0			0,0	10,0
A330-301	DEFAULT	1	Descend-Idle		6 000,0	250,0	3,1			
A330-301	DEFAULT	2	Level-Idle		3 000,0	250,0			19 547,2	
A330-301	DEFAULT	3	Level-Idle		3 000,0	200,9			10 029,5	
A330-301	DEFAULT	4	Descend-Idle		3 000,0	166,0	3,0			
A330-301	DEFAULT	5	Descend-Idle		2 547,0	154,0	3,0			
A330-301	DEFAULT	6	Descend-Idle		2 292,0	140,5	3,0			

ACFTID	Profile_ID	Step number	Step type	Flap_ID	Start Altitude (ft)	Start CAS (kt)	Descent Angle (deg)	Touchdown Roll (ft)	Distance (ft)	Start Thrust (% Max thrust)
A330-301	DEFAULT	7	Descend	FULL_D	2 144,0	130,9	3,0			
A330-301	DEFAULT	8	Descend	FULL_D	50,0	130,9	3,0			
A330-301	DEFAULT	9	Land	FULL_D				210,4		
A330-301	DEFAULT	10	Decelerate			127,9			1 893,8	10,0
A330-301	DEFAULT	11	Decelerate			30,0			0,0	10,0
A330-343	DEFAULT	1	Descend-Idle		6 000,0	250,0	2,4			
A330-343	DEFAULT	2	Level-Idle		3 000,0	250,0			20 711,9	
A330-343	DEFAULT	3	Level-Idle		3 000,0	207,9			11 430,4	
A330-343	DEFAULT	4	Descend-Idle		3 000,0	174,4	3,0			
A330-343	DEFAULT	5	Descend-Idle		2 517,0	165,0	3,0			
A330-343	DEFAULT	6	Descend-Idle		2 431,0	161,7	3,0			
A330-343	DEFAULT	7	Descend-Idle		2 113,0	146,6	3,0			
A330-343	DEFAULT	8	Descend	FULL_D	1 938,0	135,5	3,0			
A330-343	DEFAULT	9	Descend	FULL_D	50,0	135,5	3,0			
A330-343	DEFAULT	10	Land	FULL_D				378,0		
A330-343	DEFAULT	11	Decelerate			132,5			3 402,6	10,0
A330-343	DEFAULT	12	Decelerate			30,0			0,0	10,0
A340-211	DEFAULT	1	Descend-Idle		6 000,0	250,0	3,3			
A340-211	DEFAULT	2	Level-Idle		3 000,0	250,0			14 038,7	
A340-211	DEFAULT	3	Level-Idle		3 000,0	212,7			10 866,1	
A340-211	DEFAULT	4	Descend-Idle		3 000,0	175,6	3,0			
A340-211	DEFAULT	5	Descend-Idle		2 471,0	160,3	3,0			

ACFTID	Profile_ID	Step number	Step type	Flap_ID	Start Altitude (ft)	Start CAS (kt)	Descent Angle (deg)	Touchdown Roll (ft)	Distance (ft)	Start Thrust (% Max thrust)
A340-211	DEFAULT	6	Descend-Idle		2 336,0	153,8	3,0			
A340-211	DEFAULT	7	Descend-Idle		2 066,0	138,5	3,0			
A340-211	DEFAULT	8	Descend	FULL_D	1 976,0	132,1	3,0			
A340-211	DEFAULT	9	Descend	FULL_D	50,0	132,1	3,0			
A340-211	DEFAULT	10	Land	FULL_D				381,8		
A340-211	DEFAULT	11	Decelerate			129,1			3 436,6	10,0
A340-211	DEFAULT	12	Decelerate			30,0			0,0	10,0
A340-642	DEFAULT	1	Descend-Idle		6 000,0	250,0	2,8			
A340-642	DEFAULT	2	Level-Idle		3 000,0	250,0			15 853,0	
A340-642	DEFAULT	3	Level-Idle		3 000,0	212,1			9 839,2	
A340-642	DEFAULT	4	Descend-Idle		3 000,0	188,5	3,0			
A340-642	DEFAULT	5	Descend-Idle		2 333,0	178,1	3,0			
A340-642	DEFAULT	6	Descend-Idle		2 191,0	173,2	3,0			
A340-642	DEFAULT	7	Descend-Idle		1 805,0	155,5	3,0			
A340-642	DEFAULT	8	Descend	FULL_D	1 650,0	147,8	3,0			
A340-642	DEFAULT	9	Descend	FULL_D	50,0	147,8	3,0			
A340-642	DEFAULT	10	Land	FULL_D				280,7		
A340-642	DEFAULT	11	Decelerate			144,8			2 526,5	10,0
A340-642	DEFAULT	12	Decelerate			30,0			0,0	10,0
A380-841	DEFAULT	1	Descend-Idle		6 000,0	250,0	3,0			
A380-841	DEFAULT	2	Level-Idle		3 000,0	250,0			18 044,6	
A380-841	DEFAULT	3	Level	A_1+F	3 000,0				11 893,0	

ACFTID	Profile_ID	Step number	Step type	Flap_ID	Start Altitude (ft)	Start CAS (kt)	Descent Angle (deg)	Touchdown Roll (ft)	Distance (ft)	Start Thrust (% Max thrust)
A380-841	DEFAULT	4	Level-Idle		3 000,0	205,0			9 691,6	
A380-841	DEFAULT	5	Descend-Idle		3 000,0	172,6	3,0			
A380-841	DEFAULT	6	Descend-Idle		2 446,0	161,2	3,0			
A380-841	DEFAULT	7	Descend	A_FULL	1 976,0	136,3	3,0			
A380-841	DEFAULT	8	Descend	A_FULL	50,0	136,3	3,0			
A380-841	DEFAULT	9	Land	A_FULL				636,8		
A380-841	DEFAULT	10	Decelerate			136,3			5 731,3	10,0
A380-841	DEFAULT	11	Decelerate			30,0			0,0	10,0
A380-861	DEFAULT	1	Descend-Idle		6 000,0	250,0	2,7			
A380-861	DEFAULT	2	Level-Idle		3 000,0	250,0			20 036,1	
A380-861	DEFAULT	3	Level	A_1+F	3 000,0				11 896,0	
A380-861	DEFAULT	4	Level-Idle		3 000,0	205,0			10 213,0	
A380-861	DEFAULT	5	Descend-Idle		3 000,0	172,6	3,0			
A380-861	DEFAULT	6	Descend-Idle		2 445,0	161,2	3,0			
A380-861	DEFAULT	7	Descend	A_FULL	1 976,0	136,3	3,0			
A380-861	DEFAULT	8	Descend	A_FULL	50,0	136,3	3,0			
A380-861	DEFAULT	9	Land	A_FULL				636,8		
A380-861	DEFAULT	10	Decelerate			136,3			5 731,3	10,0
A380-861	DEFAULT	11	Decelerate			30,0			0,0	10,0
BAC111	DEFAULT	1	Descend	ZERO	6 000,0	250,0	3,0			
BAC111	DEFAULT	2	Descend	INT1	3 000,0	153,3	3,0			
BAC111	DEFAULT	3	Descend	U-INT	1 500,0	143,3	3,0			

ACFTID	Profile_ID	Step number	Step type	Flap_ID	Start Altitude (ft)	Start CAS (kt)	Descent Angle (deg)	Touchdown Roll (ft)	Distance (ft)	Start Thrust (% Max thrust)
BAC111	DEFAULT	4	Descend	D-45	1 000,0	133,3	3,0			
BAC111	DEFAULT	5	Land	D-45				305,0		
BAC111	DEFAULT	6	Decelerate			126,5			2 745,0	40,0
BAC111	DEFAULT	7	Decelerate			30,0			0,0	10,0
BAE146	DEFAULT	1	Descend	ZERO	6 000,0	250,0	3,0			
BAE146	DEFAULT	2	Descend	18	3 000,0	180,0	3,0			
BAE146	DEFAULT	3	Descend	D-24	1 500,0	166,5	3,0			
BAE146	DEFAULT	4	Descend	D-33	1 000,0	123,0	3,0			
BAE146	DEFAULT	5	Land	D-33				243,9		
BAE146	DEFAULT	6	Decelerate			116,7			2 195,1	40,0
BAE146	DEFAULT	7	Decelerate			30,0			0,0	10,0
BAE300	DEFAULT	1	Descend	ZERO	6 000,0	250,0	3,0			
BAE300	DEFAULT	2	Descend	18	3 000,0	180,0	3,0			
BAE300	DEFAULT	3	Descend	D-24	1 500,0	167,0	3,0			
BAE300	DEFAULT	4	Descend	D-33	1 000,0	124,4	3,0			
BAE300	DEFAULT	5	Land	D-33				261,0		
BAE300	DEFAULT	6	Decelerate			118,0			2 349,0	40,0
BAE300	DEFAULT	7	Decelerate			30,0			0,0	10,0
BEC58P	DEFAULT	1	Descend	ZERO	6 000,0	130,0	5,0			
BEC58P	DEFAULT	2	Descend	TO	3 000,0	119,0	5,0			
BEC58P	DEFAULT	3	Descend	D-15	1 500,0	109,0	5,0			
BEC58P	DEFAULT	4	Descend	D-30	1 000,0	99,0	5,0			

ACFTID	Profile_ID	Step number	Step type	Flap_ID	Start Altitude (ft)	Start CAS (kt)	Descent Angle (deg)	Touchdown Roll (ft)	Distance (ft)	Start Thrust (% Max thrust)
BEC58P	DEFAULT	5	Land	D-30				188,8		
BEC58P	DEFAULT	6	Decelerate			93,9			1 699,2	40,0
BEC58P	DEFAULT	7	Decelerate			30,0			0,0	10,0
BEC58P	STD_3DEG	1	Descend	ZERO	6 000,0	130,0	3,0			
BEC58P	STD_3DEG	2	Descend	TO	3 000,0	119,0	3,0			
BEC58P	STD_3DEG	3	Descend	D-15	1 500,0	109,0	3,0			
BEC58P	STD_3DEG	4	Descend	D-30	1 000,0	99,0	3,0			
BEC58P	STD_3DEG	5	Land	D-30				188,8		
BEC58P	STD_3DEG	6	Decelerate			93,9			1 699,2	40,0
BEC58P	STD_3DEG	7	Decelerate			30,0			0,0	10,0
BEC58P	STD_5DEG	1	Descend	ZERO	6 000,0	130,0	5,0			
BEC58P	STD_5DEG	2	Descend	TO	3 000,0	119,0	5,0			
BEC58P	STD_5DEG	3	Descend	D-15	1 500,0	109,0	5,0			
BEC58P	STD_5DEG	4	Descend	D-30	1 000,0	99,0	5,0			
BEC58P	STD_5DEG	5	Land	D-30				188,8		
BEC58P	STD_5DEG	6	Decelerate			93,9			1 699,2	40,0
BEC58P	STD_5DEG	7	Decelerate			30,0			0,0	10,0
CIT3	DEFAULT	1	Descend	ZERO	6 000,0	250,0	3,0			
CIT3	DEFAULT	2	Descend	10	3 000,0	139,5	3,0			
CIT3	DEFAULT	3	Descend	D-INTR	1 500,0	129,5	3,0			
CIT3	DEFAULT	4	Descend	D-40	1 000,0	119,5	3,0			
CIT3	DEFAULT	5	Land	D-40				153,9		

ACFTID	Profile_ID	Step number	Step type	Flap_ID	Start Altitude (ft)	Start CAS (kt)	Descent Angle (deg)	Touchdown Roll (ft)	Distance (ft)	Start Thrust (% Max thrust)
CIT3	DEFAULT	6	Decelerate			113,4			1 385,1	40,0
CIT3	DEFAULT	7	Decelerate			30,0			0,0	10,0
CL600	DEFAULT	1	Descend	ZERO	6 000,0	250,0	3,0			
CL600	DEFAULT	2	Descend	10	3 000,0	152,1	3,0			
CL600	DEFAULT	3	Descend	D-INTR	1 500,0	142,1	3,0			
CL600	DEFAULT	4	Descend	D-45	1 000,0	132,1	3,0			
CL600	DEFAULT	5	Land	D-45				201,6		
CL600	DEFAULT	6	Decelerate			125,3			1 814,4	40,0
CL600	DEFAULT	7	Decelerate			30,0			0,0	10,0
CL601	DEFAULT	1	Descend	ZERO	6 000,0	250,0	3,0			
CL601	DEFAULT	2	Descend	10	3 000,0	158,5	3,0			
CL601	DEFAULT	3	Descend	D-INTR	1 500,0	148,5	3,0			
CL601	DEFAULT	4	Descend	D-45	1 000,0	138,5	3,0			
CL601	DEFAULT	5	Land	D-45				224,1		
CL601	DEFAULT	6	Decelerate			131,4			2 016,9	40,0
CL601	DEFAULT	7	Decelerate			30,0			0,0	10,0
CNA172	DEFAULT	1	Descend	ZERO-D	6 000,0	100,0	3,0			
CNA172	DEFAULT	2	Descend	ZERO-D	4 000,0	100,0	3,0			
CNA172	DEFAULT	3	Descend	ZERO-D	3 000,0	80,0	3,0			
CNA172	DEFAULT	4	Descend	10-D	1 000,0	80,0	3,0			
CNA172	DEFAULT	5	Descend	10-D	600,0	80,0	3,0			
CNA172	DEFAULT	6	Descend	10-D	500,0	70,0	3,0			

ACFTID	Profile_ID	Step number	Step type	Flap_ID	Start Altitude (ft)	Start CAS (kt)	Descent Angle (deg)	Touchdown Roll (ft)	Distance (ft)	Start Thrust (% Max thrust)
CNA172	DEFAULT	7	Land	10-D				30,0		
CNA172	DEFAULT	8	Decelerate			62,0			530,0	10,0
CNA172	DEFAULT	9	Decelerate			10,0			0,0	10,0
CNA182	DEFAULT	1	Descend	ZERO-A	6 000,0	110,0	3,0			
CNA182	DEFAULT	2	Descend	ZERO-A	4 000,0	90,0	3,0			
CNA182	DEFAULT	3	Descend	ZERO-A	2 000,0	70,0	3,0			
CNA182	DEFAULT	4	Descend	F10APP	1 000,0	70,0	3,0			
CNA182	DEFAULT	5	Descend	F30APP	500,0	65,0	3,0			
CNA182	DEFAULT	6	Land	F30APP				30,0		
CNA182	DEFAULT	7	Decelerate			65,0			560,0	10,0
CNA182	DEFAULT	8	Decelerate			10,0			0,0	10,0
CNA208	DEFAULT	1	Descend	ZERO-A	6 000,0	140,0	3,0			
CNA208	DEFAULT	2	Descend	ZERO-A	4 000,0	124,0	3,0			
CNA208	DEFAULT	3	Descend	ZERO-A	2 000,0	108,0	3,0			
CNA208	DEFAULT	4	Descend	F30APP	1 000,0	100,0	3,0			
CNA208	DEFAULT	5	Descend	F30APP	500,0	80,0	3,0			
CNA208	DEFAULT	6	Land	F30APP				100,0		
CNA208	DEFAULT	7	Decelerate			78,0			815,0	10,0
CNA208	DEFAULT	8	Decelerate			30,0			0,0	10,0
CNA441	DEFAULT	1	Descend	ZERO	6 000,0	160,0	3,0			
CNA441	DEFAULT	2	Descend	TO	3 000,0	113,9	3,0			
CNA441	DEFAULT	3	Descend	D-INTR	1 500,0	103,9	3,0			

ACFTID	Profile_ID	Step number	Step type	Flap_ID	Start Altitude (ft)	Start CAS (kt)	Descent Angle (deg)	Touchdown Roll (ft)	Distance (ft)	Start Thrust (% Max thrust)
CNA441	DEFAULT	4	Descend	D-L	1 000,0	93,9	3,0			
CNA441	DEFAULT	5	Land	D-L				79,1		
CNA441	DEFAULT	6	Decelerate			89,1			711,9	40,0
CNA441	DEFAULT	7	Decelerate			30,0			0,0	10,0
CNA500	DEFAULT	1	Descend	ZERO	6 000,0	250,0	3,0			
CNA500	DEFAULT	2	Descend	1	3 000,0	131,3	3,0			
CNA500	DEFAULT	3	Descend	D-INTR	1 500,0	121,3	3,0			
CNA500	DEFAULT	4	Descend	D-35	1 000,0	111,3	3,0			
CNA500	DEFAULT	5	Land	D-35				179,1		
CNA500	DEFAULT	6	Decelerate			105,6			1 611,9	40,0
CNA500	DEFAULT	7	Decelerate			30,0			0,0	10,0
CNA510	DEFAULT	1	Descend	ZERO_C	6 000,0	250,0	3,0			
CNA510	DEFAULT	2	Descend	ZERO_C	3 000,0	160,0	3,0			
CNA510	DEFAULT	3	Descend	A_15	1 500,0	91,1	3,0			
CNA510	DEFAULT	4	Descend	A_35	1 000,0	85,1	3,0			
CNA510	DEFAULT	5	Land	A_35				175,5		
CNA510	DEFAULT	6	Decelerate			78,1			1 579,5	40,0
CNA510	DEFAULT	7	Decelerate			30,0			0,0	10,0
CNA525C	DEFAULT	1	Descend	ZERO_C	6 000,0	250,0	3,0			
CNA525C	DEFAULT	2	Descend	ZERO_C	3 000,0	130,0	3,0			
CNA525C	DEFAULT	3	Descend	A_15	1 500,0	119,7	3,0			
CNA525C	DEFAULT	4	Descend	A_35	1 000,0	111,8	3,0			

ACFTID	Profile_ID	Step number	Step type	Flap_ID	Start Altitude (ft)	Start CAS (kt)	Descent Angle (deg)	Touchdown Roll (ft)	Distance (ft)	Start Thrust (% Max thrust)
CNA525C	DEFAULT	5	Land	A_35				200,0		
CNA525C	DEFAULT	6	Decelerate			115,0			1 500,0	40,0
CNA525C	DEFAULT	7	Decelerate			30,0			0,0	10,0
CNA55B	DEFAULT	1	Descend	ZERO_C	6 000,0	250,0	3,0			
CNA55B	DEFAULT	2	Descend	ZERO_C	3 000,0	160,0	3,0			
CNA55B	DEFAULT	3	Descend	A_15	1 500,0	111,8	3,0			
CNA55B	DEFAULT	4	Descend	A_35	1 000,0	105,3	3,0			
CNA55B	DEFAULT	5	Land	A_35				175,5		
CNA55B	DEFAULT	6	Decelerate			100,0			1 580,0	40,0
CNA55B	DEFAULT	7	Decelerate			30,0			0,0	10,0
CNA560E	DEFAULT	1	Descend	ZERO	6 000,0	250,0	3,0			
CNA560E	DEFAULT	2	Descend	15 U	3 000,0	107,5	3,0			
CNA560E	DEFAULT	3	Descend	35 D	1 500,0	101,8	3,0			
CNA560E	DEFAULT	4	Descend	35 D	1 000,0	101,8	3,0			
CNA560E	DEFAULT	5	Land	35 D				200,0		
CNA560E	DEFAULT	6	Decelerate			100,0			1 000,0	60,0
CNA560E	DEFAULT	7	Decelerate			30,0			0,0	10,0
CNA560U	DEFAULT	1	Descend	ZERO	6 000,0	250,0	3,0			
CNA560U	DEFAULT	2	Descend	7	3 000,0	120,0	3,0			
CNA560U	DEFAULT	3	Descend	D 15	1 500,0	110,0	3,0			
CNA560U	DEFAULT	4	Descend	D 35	1 000,0	101,8	3,0			
CNA560U	DEFAULT	5	Land	D 35				175,0		

ACFTID	Profile_ID	Step number	Step type	Flap_ID	Start Altitude (ft)	Start CAS (kt)	Descent Angle (deg)	Touchdown Roll (ft)	Distance (ft)	Start Thrust (% Max thrust)
CNA560U	DEFAULT	6	Decelerate			93,0			1 385,1	60,0
CNA560U	DEFAULT	7	Decelerate			30,0			0,0	10,0
CNA560XL	DEFAULT	1	Descend	ZERO	6 000,0	250,0	3,0			
CNA560XL	DEFAULT	2	Descend	ZERO	3 000,0	132,0	3,0			
CNA560XL	DEFAULT	3	Descend	D 15U	1 500,0	122,0	3,0			
CNA560XL	DEFAULT	4	Descend	D 35D	1 000,0	112,0	3,0			
CNA560XL	DEFAULT	5	Land	D 35D				500,0		
CNA560XL	DEFAULT	6	Decelerate			108,0			2 700,0	60,0
CNA560XL	DEFAULT	7	Decelerate			30,0			0,0	10,0
CNA680	DEFAULT	1	Descend	ZERO	6 000,0	250,0	3,0			
CNA680	DEFAULT	2	Descend	ZERO	3 000,0	160,0	3,0			
CNA680	DEFAULT	3	Descend	15 GU	1 500,0	112,0	3,0			
CNA680	DEFAULT	4	Descend	35 GD	1 000,0	105,0	3,0			
CNA680	DEFAULT	5	Land	35 GD				200,0		
CNA680	DEFAULT	6	Decelerate			100,0			1 580,0	60,0
CNA680	DEFAULT	7	Decelerate			30,0			0,0	10,0
CNA750	DEFAULT	1	Descend	ZERO	6 000,0	250,0	3,0			
CNA750	DEFAULT	2	Descend	15_GU	3 000,0	127,4	3,0			
CNA750	DEFAULT	3	Descend	35_GD	1 500,0	120,9	3,0			
CNA750	DEFAULT	4	Descend	35_GD	1 000,0	120,9	3,0			
CNA750	DEFAULT	5	Land	35_GD				200,0		
CNA750	DEFAULT	6	Decelerate			115,0			1 500,0	40,0

ACFTID	Profile_ID	Step number	Step type	Flap_ID	Start Altitude (ft)	Start CAS (kt)	Descent Angle (deg)	Touchdown Roll (ft)	Distance (ft)	Start Thrust (% Max thrust)
CNA750	DEFAULT	7	Decelerate			30,0			0,0	10,0
CNA750	FLAP_15	1	Descend	ZERO	6 000,0	250,0	3,0			
CNA750	FLAP_15	2	Descend	15_GU	3 000,0	127,4	3,0			
CNA750	FLAP_15	3	Descend	35_GD	1 500,0	120,9	3,0			
CNA750	FLAP_15	4	Descend	35_GD	1 000,0	120,9	3,0			
CNA750	FLAP_15	5	Land	35_GD				200,0		
CNA750	FLAP_15	6	Decelerate			115,0			1 500,0	40,0
CNA750	FLAP_15	7	Decelerate			30,0			0,0	10,0
CNA750	FLAP_5	1	Descend	ZERO	6 000,0	250,0	3,0			
CNA750	FLAP_5	2	Descend	5_GU	3 000,0	135,2	3,0			
CNA750	FLAP_5	3	Descend	15_GD	1 500,0	127,4	3,0			
CNA750	FLAP_5	4	Descend	15_GD	1 000,0	127,4	3,0			
CNA750	FLAP_5	5	Land	15_GD				200,0		
CNA750	FLAP_5	6	Decelerate			115,0			1 500,0	40,0
CNA750	FLAP_5	7	Decelerate			30,0			0,0	10,0
CONCRD	DEFAULT	1	Descend	CL1	6 000,0	250,0	3,0			
CONCRD	DEFAULT	2	Descend	ZERO	3 000,0	194,0	3,0			
CONCRD	DEFAULT	3	Descend	U-L	1 500,0	184,0	3,0			
CONCRD	DEFAULT	4	Descend	D-L	1 000,0	164,0	3,0			
CONCRD	DEFAULT	5	Land	D-L				858,6		
CONCRD	DEFAULT	6	Decelerate			155,5			7 727,4	40,0
CONCRD	DEFAULT	7	Decelerate			30,0			0,0	10,0

ACFTID	Profile_ID	Step number	Step type	Flap_ID	Start Altitude (ft)	Start CAS (kt)	Descent Angle (deg)	Touchdown Roll (ft)	Distance (ft)	Start Thrust (% Max thrust)
CRJ9-ER	DEFAULT	1	Descend	ZERO	6 000,0	250,0	3,0			
CRJ9-ER	DEFAULT	2	Descend	20	3 500,0	170,0	3,0			
CRJ9-ER	DEFAULT	3	Descend	U-45	1 500,0	160,0	3,0			
CRJ9-ER	DEFAULT	4	Descend	D-45	1 000,0	140,0	3,0			
CRJ9-ER	DEFAULT	5	Land	D-45				415,8		
CRJ9-ER	DEFAULT	6	Decelerate			143,0			2 528,0	10,0
CRJ9-ER	DEFAULT	7	Decelerate			30,0			0,0	10,0
CRJ9-LR	DEFAULT	1	Descend	ZERO	6 000,0	250,0	3,0			
CRJ9-LR	DEFAULT	2	Descend	20	3 500,0	170,0	3,0			
CRJ9-LR	DEFAULT	3	Descend	U-45	1 500,0	160,0	3,0			
CRJ9-LR	DEFAULT	4	Descend	D-45	1 000,0	141,0	3,0			
CRJ9-LR	DEFAULT	5	Land	D-45				424,7		
CRJ9-LR	DEFAULT	6	Decelerate			144,0			2 577,0	10,0
CRJ9-LR	DEFAULT	7	Decelerate			30,0			0,0	10,0
CVR580	DEFAULT	1	Descend	ZERO	6 000,0	200,0	3,0			
CVR580	DEFAULT	2	Descend	INTR	3 000,0	146,3	3,0			
CVR580	DEFAULT	3	Descend	D-28	1 500,0	112,4	3,0			
CVR580	DEFAULT	4	Descend	D-40	1 000,0	106,3	3,0			
CVR580	DEFAULT	5	Land	D-40				287,6		
CVR580	DEFAULT	6	Decelerate			100,9			2 588,4	40,0
CVR580	DEFAULT	7	Decelerate			30,0			0,0	10,0
DC1010	DEFAULT	1	Descend	ZERO	6 000,0	250,0	3,0			

ACFTID	Profile_ID	Step number	Step type	Flap_ID	Start Altitude (ft)	Start CAS (kt)	Descent Angle (deg)	Touchdown Roll (ft)	Distance (ft)	Start Thrust (% Max thrust)
DC1010	DEFAULT	2	Descend	INT	3 000,0	163,7	3,0			
DC1010	DEFAULT	3	Descend	U-35	1 500,0	153,7	3,0			
DC1010	DEFAULT	4	Descend	D-35	1 000,0	143,7	3,0			
DC1010	DEFAULT	5	Land	D-35				428,4		
DC1010	DEFAULT	6	Decelerate			136,3			3 855,6	10,0
DC1010	DEFAULT	7	Decelerate			30,0			0,0	10,0
DC1030	DEFAULT	1	Descend	ZERO	6 000,0	250,0	3,0			
DC1030	DEFAULT	2	Descend	INT2	3 000,0	172,6	3,0			
DC1030	DEFAULT	3	Descend	U-20	1 500,0	162,6	3,0			
DC1030	DEFAULT	4	Descend	D-35	1 000,0	152,6	3,0			
DC1030	DEFAULT	5	Land	D-35				392,2		
DC1030	DEFAULT	6	Decelerate			144,8			3 529,8	10,0
DC1030	DEFAULT	7	Decelerate			30,0			0,0	10,0
DC1040	DEFAULT	1	Descend	ZERO	6 000,0	250,0	3,0			
DC1040	DEFAULT	2	Descend	5	3 000,0	173,5	3,0			
DC1040	DEFAULT	3	Descend	U-35	1 500,0	163,5	3,0			
DC1040	DEFAULT	4	Descend	D-35	1 000,0	153,5	3,0			
DC1040	DEFAULT	5	Land	D-35				446,4		
DC1040	DEFAULT	6	Decelerate			145,6			4 017,6	10,0
DC1040	DEFAULT	7	Decelerate			30,0			0,0	10,0
DC3	DEFAULT	1	Descend	ZERO	6 000,0	140,0	3,0			
DC3	DEFAULT	2	Descend	TO	3 000,0	109,0	3,0			

ACFTID	Profile_ID	Step number	Step type	Flap_ID	Start Altitude (ft)	Start CAS (kt)	Descent Angle (deg)	Touchdown Roll (ft)	Distance (ft)	Start Thrust (% Max thrust)
DC3	DEFAULT	3	Descend	U-INT	1 500,0	99,0	3,0			
DC3	DEFAULT	4	Descend	D-45	1 000,0	88,9	3,0			
DC3	DEFAULT	5	Land	D-45				104,6		
DC3	DEFAULT	6	Decelerate			84,3			941,4	34,3
DC3	DEFAULT	7	Decelerate			30,0			0,0	10,0
DC6	DEFAULT	1	Descend	ZERO	6 000,0	160,0	3,0			
DC6	DEFAULT	2	Descend	TO	3 000,0	106,1	3,0			
DC6	DEFAULT	3	Descend	D-INTR	1 500,0	96,1	3,0			
DC6	DEFAULT	4	Descend	D-L	1 000,0	86,1	3,0			
DC6	DEFAULT	5	Land	D-L				175,5		
DC6	DEFAULT	6	Decelerate			81,7			1 579,5	40,0
DC6	DEFAULT	7	Decelerate			30,0			0,0	10,0
DC850	DEFAULT	1	Descend	ZERO	6 000,0	250,0	3,0			
DC850	DEFAULT	2	Descend	INT	3 000,0	165,6	3,0			
DC850	DEFAULT	3	Descend	D-35	1 500,0	152,7	3,0			
DC850	DEFAULT	4	Descend	D-50	1 000,0	145,6	3,0			
DC850	DEFAULT	5	Land	D-50				390,6		
DC850	DEFAULT	6	Decelerate			138,1			3 515,4	40,0
DC850	DEFAULT	7	Decelerate			30,0			0,0	10,0
DC860	DEFAULT	1	Descend	ZERO	6 000,0	250,0	3,0			
DC860	DEFAULT	2	Descend	INT	3 000,0	161,5	3,0			
DC860	DEFAULT	3	Descend	D-35	1 500,0	155,7	3,0			

ACFTID	Profile_ID	Step number	Step type	Flap_ID	Start Altitude (ft)	Start CAS (kt)	Descent Angle (deg)	Touchdown Roll (ft)	Distance (ft)	Start Thrust (% Max thrust)
DC860	DEFAULT	4	Descend	D-50	1 000,0	151,5	3,0			
DC860	DEFAULT	5	Land	D-50				382,5		
DC860	DEFAULT	6	Decelerate			143,7			3 442,5	40,0
DC860	DEFAULT	7	Decelerate			30,0			0,0	10,0
DC870	DEFAULT	1	Descend	ZERO	6 000,0	250,0	3,0			
DC870	DEFAULT	2	Descend	INT	3 000,0	166,7	3,0			
DC870	DEFAULT	3	Descend	D-35	1 500,0	150,8	3,0			
DC870	DEFAULT	4	Descend	D-50	1 000,0	146,7	3,0			
DC870	DEFAULT	5	Land	D-50				489,6		
DC870	DEFAULT	6	Decelerate			139,2			4 406,4	40,0
DC870	DEFAULT	7	Decelerate			30,0			0,0	10,0
DC8QN	DEFAULT	1	Descend	ZERO	6 000,0	250,0	3,0			
DC8QN	DEFAULT	2	Descend	INT	3 000,0	161,5	3,0			
DC8QN	DEFAULT	3	Descend	D-35	1 500,0	155,7	3,0			
DC8QN	DEFAULT	4	Descend	D-50	1 000,0	151,5	3,0			
DC8QN	DEFAULT	5	Land	D-50				382,5		
DC8QN	DEFAULT	6	Decelerate			143,7			3 442,5	40,0
DC8QN	DEFAULT	7	Decelerate			30,0			0,0	10,0
DC910	DEFAULT	1	Descend	ZERO	6 000,0	250,0	3,0			
DC910	DEFAULT	2	Descend	5	3 000,0	150,2	3,0			
DC910	DEFAULT	3	Descend	U-15	1 500,0	140,2	3,0			
DC910	DEFAULT	4	Descend	D-35	1 000,0	130,2	3,0			

ACFTID	Profile_ID	Step number	Step type	Flap_ID	Start Altitude (ft)	Start CAS (kt)	Descent Angle (deg)	Touchdown Roll (ft)	Distance (ft)	Start Thrust (% Max thrust)
DC910	DEFAULT	5	Land	D-35				357,3		
DC910	DEFAULT	6	Decelerate			123,5			3 215,7	40,0
DC910	DEFAULT	7	Decelerate			30,0			0,0	10,0
DC930	DEFAULT	1	Descend	ZERO	6 000,0	250,0	3,0			
DC930	DEFAULT	2	Descend	5	3 000,0	162,5	3,0			
DC930	DEFAULT	3	Descend	U-15	1 500,0	152,5	3,0			
DC930	DEFAULT	4	Descend	D-35	1 000,0	142,5	3,0			
DC930	DEFAULT	5	Land	D-35				325,8		
DC930	DEFAULT	6	Decelerate			135,2			2 932,2	40,0
DC930	DEFAULT	7	Decelerate			30,0			0,0	10,0
DC93LW	DEFAULT	1	Descend	ZERO	6 000,0	250,0	3,0			
DC93LW	DEFAULT	2	Descend	5	3 000,0	162,5	3,0			
DC93LW	DEFAULT	3	Descend	U-15	1 500,0	152,5	3,0			
DC93LW	DEFAULT	4	Descend	D-35	1 000,0	142,5	3,0			
DC93LW	DEFAULT	5	Land	D-35				325,8		
DC93LW	DEFAULT	6	Decelerate			135,2			2 932,2	40,0
DC93LW	DEFAULT	7	Decelerate			30,0			0,0	10,0
DC950	DEFAULT	1	Descend	ZERO	6 000,0	250,0	3,0			
DC950	DEFAULT	2	Descend	5	3 000,0	167,3	3,0			
DC950	DEFAULT	3	Descend	U-15	1 500,0	157,3	3,0			
DC950	DEFAULT	4	Descend	D-35	1 000,0	147,3	3,0			
DC950	DEFAULT	5	Land	D-35				343,8		

ACFTID	Profile_ID	Step number	Step type	Flap_ID	Start Altitude (ft)	Start CAS (kt)	Descent Angle (deg)	Touchdown Roll (ft)	Distance (ft)	Start Thrust (% Max thrust)
DC950	DEFAULT	6	Decelerate			139,7			3 094,2	40,0
DC950	DEFAULT	7	Decelerate			30,0			0,0	10,0
DC95HW	DEFAULT	1	Descend	ZERO	6 000,0	250,0	3,0			
DC95HW	DEFAULT	2	Descend	5	3 000,0	167,3	3,0			
DC95HW	DEFAULT	3	Descend	U-15	1 500,0	157,3	3,0			
DC95HW	DEFAULT	4	Descend	D-35	1 000,0	147,3	3,0			
DC95HW	DEFAULT	5	Land	D-35				343,8		
DC95HW	DEFAULT	6	Decelerate			139,7			3 094,2	40,0
DC95HW	DEFAULT	7	Decelerate			30,0			0,0	10,0
DC9Q7	DEFAULT	1	Descend	ZERO	6 000,0	250,0	3,0			
DC9Q7	DEFAULT	2	Descend	5	3 000,0	150,2	3,0			
DC9Q7	DEFAULT	3	Descend	U-15	1 500,0	140,2	3,0			
DC9Q7	DEFAULT	4	Descend	D-35	1 000,0	130,2	3,0			
DC9Q7	DEFAULT	5	Land	D-35				357,3		
DC9Q7	DEFAULT	6	Decelerate			123,5			3 215,7	40,0
DC9Q7	DEFAULT	7	Decelerate			30,0			0,0	10,0
DC9Q9	DEFAULT	1	Descend	ZERO	6 000,0	250,0	3,0			
DC9Q9	DEFAULT	2	Descend	5	3 000,0	162,5	3,0			
DC9Q9	DEFAULT	3	Descend	U-15	1 500,0	152,5	3,0			
DC9Q9	DEFAULT	4	Descend	D-35	1 000,0	142,5	3,0			
DC9Q9	DEFAULT	5	Land	D-35				325,8		
DC9Q9	DEFAULT	6	Decelerate			135,2			2 932,2	40,0

ACFTID	Profile_ID	Step number	Step type	Flap_ID	Start Altitude (ft)	Start CAS (kt)	Descent Angle (deg)	Touchdown Roll (ft)	Distance (ft)	Start Thrust (% Max thrust)
DC9Q9	DEFAULT	7	Decelerate			30,0			0,0	10,0
DHC6	DEFAULT	1	Descend	ZERO	6 000,0	120,0	3,0			
DHC6	DEFAULT	2	Descend	INTR	3 000,0	80,7	3,0			
DHC6	DEFAULT	3	Descend	D-INTR	1 500,0	70,7	3,0			
DHC6	DEFAULT	4	Descend	D-L	1 000,0	60,7	3,0			
DHC6	DEFAULT	5	Land	D-L				39,6		
DHC6	DEFAULT	6	Decelerate			57,6			356,4	40,0
DHC6	DEFAULT	7	Decelerate			30,0			0,0	10,0
DHC6QP	DEFAULT	1	Descend	ZERO	6 000,0	120,0	3,0			
DHC6QP	DEFAULT	2	Descend	INTR	3 000,0	80,7	3,0			
DHC6QP	DEFAULT	3	Descend	D-INTR	1 500,0	70,7	3,0			
DHC6QP	DEFAULT	4	Descend	D-L	1 000,0	60,7	3,0			
DHC6QP	DEFAULT	5	Land	D-L				39,6		
DHC6QP	DEFAULT	6	Decelerate			57,6			356,4	40,0
DHC6QP	DEFAULT	7	Decelerate			30,0			0,0	10,0
DHC7	DEFAULT	1	Descend	ZERO	6 000,0	160,0	3,0			
DHC7	DEFAULT	2	Descend	10	3 000,0	116,2	3,0			
DHC7	DEFAULT	3	Descend	D-INTR	1 500,0	106,2	3,0			
DHC7	DEFAULT	4	Descend	D-25	1 000,0	96,2	3,0			
DHC7	DEFAULT	5	Land	D-25				98,1		
DHC7	DEFAULT	6	Decelerate			91,3			882,9	40,0
DHC7	DEFAULT	7	Decelerate			30,0			0,0	10,0

ACFTID	Profile_ID	Step number	Step type	Flap_ID	Start Altitude (ft)	Start CAS (kt)	Descent Angle (deg)	Touchdown Roll (ft)	Distance (ft)	Start Thrust (% Max thrust)
DHC8	DEFAULT	1	Descend	ZERO	6 000,0	165,0	3,0			
DHC8	DEFAULT	2	Descend	5	3 000,0	109,0	3,0			
DHC8	DEFAULT	3	Descend	D-15	1 500,0	96,0	3,0			
DHC8	DEFAULT	4	Descend	D-35	1 000,0	89,0	3,0			
DHC8	DEFAULT	5	Land	D-35				174,6		
DHC8	DEFAULT	6	Decelerate			84,4			1 571,4	24,6
DHC8	DEFAULT	7	Decelerate			30,0			0,0	4,1
DHC830	DEFAULT	1	Descend	ZERO	6 000,0	179,0	3,0			
DHC830	DEFAULT	2	Descend	10	3 000,0	128,0	3,0			
DHC830	DEFAULT	3	Descend	D-15	1 500,0	116,9	3,0			
DHC830	DEFAULT	4	Descend	D-35	1 000,0	108,0	3,0			
DHC830	DEFAULT	5	Land	D-35				219,6		
DHC830	DEFAULT	6	Decelerate			102,5			1 976,4	26,1
DHC830	DEFAULT	7	Decelerate			30,0			0,0	4,4
DO228	DEFAULT	1	Descend	ZERO-A	6 000,0	200,0	3,0			
DO228	DEFAULT	2	Descend	ZERO-A	4 000,0	160,0	3,0			
DO228	DEFAULT	3	Descend	ZERO-A	2 000,0	120,0	3,0			
DO228	DEFAULT	4	Descend	F30APP	1 000,0	100,0	3,0			
DO228	DEFAULT	5	Descend	F30APP	50,0	88,0	3,0			
DO228	DEFAULT	6	Land	F30APP				100,0		
DO228	DEFAULT	7	Decelerate			80,0			1 320,9	10,0
DO228	DEFAULT	8	Decelerate			30,0			0,0	10,0

ACFTID	Profile_ID	Step number	Step type	Flap_ID	Start Altitude (ft)	Start CAS (kt)	Descent Angle (deg)	Touchdown Roll (ft)	Distance (ft)	Start Thrust (% Max thrust)
DO328	DEFAULT	1	Descend	ZERO-A	6 000,0	200,0	3,0			
DO328	DEFAULT	2	Descend	ZERO-A	4 000,0	175,0	3,0			
DO328	DEFAULT	3	Descend	ZERO-A	2 000,0	150,0	3,0			
DO328	DEFAULT	4	Descend	F32APP	1 000,0	109,0	3,0			
DO328	DEFAULT	5	Descend	F32APP	500,0	109,0	3,0			
DO328	DEFAULT	6	Land	F32APP				50,0		
DO328	DEFAULT	7	Decelerate			109,0			2 216,0	10,0
DO328	DEFAULT	8	Decelerate			30,0			0,0	10,0
ECLIPSE500	DEFAULT	1	Descend	A_T_DN	6 000,0	170,0	3,0			
ECLIPSE500	DEFAULT	2	Descend	A_T_DN	5 000,0	160,0	3,0			
ECLIPSE500	DEFAULT	3	Descend	A_A_DN	3 000,0	100,4	3,0			
ECLIPSE500	DEFAULT	4	Descend	A_A_DN	2 000,0	100,4	3,0			
ECLIPSE500	DEFAULT	5	Descend	A_A_DN	1 000,0	100,4	3,0			
ECLIPSE500	DEFAULT	6	Descend	A_A_DN	100,0	90,4	3,0			
ECLIPSE500	DEFAULT	7	Land	A_A_DN				144,0		
ECLIPSE500	DEFAULT	8	Decelerate			70,0			1 291,0	10,0
ECLIPSE500	DEFAULT	9	Decelerate			20,0			0,0	10,0
EMB120	DEFAULT	1	Descend	ZERO	6 000,0	141,5	3,0			
EMB120	DEFAULT	2	Descend	15	3 000,0	132,3	3,0			
EMB120	DEFAULT	3	Descend	D-25	1 500,0	127,4	3,0			
EMB120	DEFAULT	4	Descend	D-45	1 000,0	119,3	3,0			
EMB120	DEFAULT	5	Land	D-45				95,0		

ACFTID	Profile_ID	Step number	Step type	Flap_ID	Start Altitude (ft)	Start CAS (kt)	Descent Angle (deg)	Touchdown Roll (ft)	Distance (ft)	Start Thrust (% Max thrust)
EMB120	DEFAULT	6	Decelerate			116,1			855,0	40,0
EMB120	DEFAULT	7	Decelerate			30,0			0,0	10,0
EMB145	DEFAULT	1	Descend	ZERO	6 000,0	250,0	3,0			
EMB145	DEFAULT	2	Descend	D-22	3 000,0	150,0	3,0			
EMB145	DEFAULT	3	Descend	D-45	1 500,0	140,0	3,0			
EMB145	DEFAULT	4	Descend	D-45	1 000,0	134,0	3,0			
EMB145	DEFAULT	5	Land	D-45				285,5		
EMB145	DEFAULT	6	Decelerate			130,0			2 569,5	40,0
EMB145	DEFAULT	7	Decelerate			30,0			0,0	10,0
EMB14L	DEFAULT	1	Descend	ZERO	6 000,0	250,0	3,0			
EMB14L	DEFAULT	2	Descend	D-22	1 500,0	140,0	3,0			
EMB14L	DEFAULT	3	Descend	D-45	1 000,0	140,0	3,0			
EMB14L	DEFAULT	4	Descend	D-45	500,0	138,0	3,0			
EMB14L	DEFAULT	5	Land	D-45				285,5		
EMB14L	DEFAULT	6	Decelerate			132,0			2 569,5	40,0
EMB14L	DEFAULT	7	Decelerate			30,0			0,0	10,0
EMB170	DEFAULT	1	Descend-Idle		6 000,0	250,0	3,0			
EMB170	DEFAULT	2	Descend-Idle		3 000,0	180,0	3,0			
EMB170	DEFAULT	3	Descend-Idle		2 000,0	140,0	3,0			
EMB170	DEFAULT	4	Descend	FULL	1 500,0	130,0	3,0			
EMB170	DEFAULT	5	Land	FULL				267,2		
EMB170	DEFAULT	6	Decelerate			120,0			2 405,0	40,0

ACFTID	Profile_ID	Step number	Step type	Flap_ID	Start Altitude (ft)	Start CAS (kt)	Descent Angle (deg)	Touchdown Roll (ft)	Distance (ft)	Start Thrust (% Max thrust)
EMB170	DEFAULT	7	Decelerate			30,0			0,0	10,0
EMB175	DEFAULT	1	Descend-Idle		6 000,0	250,0	3,0			
EMB175	DEFAULT	2	Descend-Idle		3 000,0	180,0	3,0			
EMB175	DEFAULT	3	Descend-Idle		2 000,0	140,0	3,0			
EMB175	DEFAULT	4	Descend	FULL	1 500,0	130,0	3,0			
EMB175	DEFAULT	5	Land	FULL				276,3		
EMB175	DEFAULT	6	Decelerate			120,0			2 487,0	40,0
EMB175	DEFAULT	7	Decelerate			30,0			0,0	10,0
EMB190	DEFAULT	1	Descend-Idle		6 000,0	250,0	3,0			
EMB190	DEFAULT	2	Descend-Idle		3 000,0	180,0	3,0			
EMB190	DEFAULT	3	Descend-Idle		2 000,0	140,0	3,0			
EMB190	DEFAULT	4	Descend	FULL	1 500,0	130,0	3,0			
EMB190	DEFAULT	5	Land	FULL				271,9		
EMB190	DEFAULT	6	Decelerate			120,0			2 447,0	40,0
EMB190	DEFAULT	7	Decelerate			30,0			0,0	10,0
EMB195	DEFAULT	1	Descend-Idle		6 000,0	250,0	3,0			
EMB195	DEFAULT	2	Descend-Idle		3 000,0	180,0	3,0			
EMB195	DEFAULT	3	Descend-Idle		2 000,0	140,0	3,0			
EMB195	DEFAULT	4	Descend	FULL	1 500,0	130,0	3,0			
EMB195	DEFAULT	5	Land	FULL				281,1		
EMB195	DEFAULT	6	Decelerate			120,0			2 530,0	40,0
EMB195	DEFAULT	7	Decelerate			30,0			0,0	10,0

ACFTID	Profile_ID	Step number	Step type	Flap_ID	Start Altitude (ft)	Start CAS (kt)	Descent Angle (deg)	Touchdown Roll (ft)	Distance (ft)	Start Thrust (% Max thrust)
F10062	DEFAULT	1	Descend	TO	6 000,0	250,0	3,0			
F10062	DEFAULT	2	Descend	INT2	3 000,0	161,3	3,0			
F10062	DEFAULT	3	Descend	U-INT	1 500,0	141,3	3,0			
F10062	DEFAULT	4	Descend	D-42	1 000,0	131,3	3,0			
F10062	DEFAULT	5	Land	D-42				315,0		
F10062	DEFAULT	6	Decelerate			124,5			2 835,0	40,0
F10062	DEFAULT	7	Decelerate			30,0			0,0	10,0
F10065	DEFAULT	1	Descend	TO	6 000,0	250,0	3,0			
F10065	DEFAULT	2	Descend	INT2	3 000,0	163,1	3,0			
F10065	DEFAULT	3	Descend	U-INT	1 500,0	143,1	3,0			
F10065	DEFAULT	4	Descend	D-42	1 000,0	133,1	3,0			
F10065	DEFAULT	5	Land	D-42				328,0		
F10065	DEFAULT	6	Decelerate			126,3			2 952,0	40,0
F10065	DEFAULT	7	Decelerate			30,0			0,0	10,0
F28MK2	DEFAULT	1	Descend	ZERO	6 000,0	250,0	3,0			
F28MK2	DEFAULT	2	Descend	INT2	3 000,0	152,9	3,0			
F28MK2	DEFAULT	3	Descend	U-INTR	1 500,0	132,9	3,0			
F28MK2	DEFAULT	4	Descend	D-42	1 000,0	122,9	3,0			
F28MK2	DEFAULT	5	Land	D-42				223,2		
F28MK2	DEFAULT	6	Decelerate			116,6			2 008,8	40,0
F28MK2	DEFAULT	7	Decelerate			30,0			0,0	10,0
F28MK4	DEFAULT	1	Descend	ZERO	6 000,0	250,0	3,0			

ACFTID	Profile_ID	Step number	Step type	Flap_ID	Start Altitude (ft)	Start CAS (kt)	Descent Angle (deg)	Touchdown Roll (ft)	Distance (ft)	Start Thrust (% Max thrust)
F28MK4	DEFAULT	2	Descend	INT2	3 000,0	153,6	3,0			
F28MK4	DEFAULT	3	Descend	U-INTR	1 500,0	133,6	3,0			
F28MK4	DEFAULT	4	Descend	D-42	1 000,0	123,6	3,0			
F28MK4	DEFAULT	5	Land	D-42				223,7		
F28MK4	DEFAULT	6	Decelerate			117,2			2 013,3	40,0
F28MK4	DEFAULT	7	Decelerate			30,0			0,0	10,0
FAL20	DEFAULT	1	Descend	ZERO	6 000,0	250,0	3,0			
FAL20	DEFAULT	2	Descend	INTR	3 000,0	142,2	3,0			
FAL20	DEFAULT	3	Descend	D-25	1 500,0	126,1	3,0			
FAL20	DEFAULT	4	Descend	D-40	1 000,0	124,2	3,0			
FAL20	DEFAULT	5	Land	D-40				128,7		
FAL20	DEFAULT	6	Decelerate			117,9			1 158,3	40,0
FAL20	DEFAULT	7	Decelerate			30,0			0,0	10,0
GII	DEFAULT	1	Descend	L-0-U	6 000,0	230,0	3,0			
GII	DEFAULT	2	Descend	L-10-U	3 000,0	170,0	3,0			
GII	DEFAULT	3	Descend	L-20-D	1 500,0	153,6	3,0			
GII	DEFAULT	4	Descend	L-20-D	1 000,0	153,6	3,0			
GII	DEFAULT	5	Descend	L-39-D	200,0	143,6	3,0			
GII	DEFAULT	6	Land	L-39-D				790,0		
GII	DEFAULT	7	Decelerate			117,0			760,0	40,0
GII	DEFAULT	8	Decelerate			20,0			0,0	10,0
GIB	DEFAULT	1	Descend	L-0-U	6 000,0	230,0	3,0			

ACFTID	Profile_ID	Step number	Step type	Flap_ID	Start Altitude (ft)	Start CAS (kt)	Descent Angle (deg)	Touchdown Roll (ft)	Distance (ft)	Start Thrust (% Max thrust)
GIB	DEFAULT	2	Descend	L-10-U	3 000,0	170,0	3,0			
GIB	DEFAULT	3	Descend	L-20-D	1 500,0	149,2	3,0			
GIB	DEFAULT	4	Descend	L-20-D	1 000,0	149,2	3,0			
GIB	DEFAULT	5	Descend	L-39-D	200,0	139,2	3,0			
GIB	DEFAULT	6	Land	L-39-D				790,0		
GIB	DEFAULT	7	Decelerate			113,0			760,0	40,0
GIB	DEFAULT	8	Decelerate			20,0			0,0	10,0
GIV	DEFAULT	1	Descend	L-0-U	6 000,0	250,0	3,0			
GIV	DEFAULT	2	Descend	L-0-U	3 000,0	160,0	3,0			
GIV	DEFAULT	3	Descend	L-20-D	1 500,0	160,0	3,0			
GIV	DEFAULT	4	Descend	L-39-D	1 000,0	151,5	3,0			
GIV	DEFAULT	5	Land	L-39-D				298,0		
GIV	DEFAULT	6	Decelerate			80,0			982,0	40,0
GIV	DEFAULT	7	Decelerate			20,0			0,0	4,0
GV	DEFAULT	1	Descend	L-0-U	6 000,0	250,0	3,0			
GV	DEFAULT	2	Descend	L-20-U	3 000,0	160,0	3,0			
GV	DEFAULT	3	Descend	L-20-D	1 500,0	160,0	3,0			
GV	DEFAULT	4	Descend	L-39-D	1 000,0	137,8	3,0			
GV	DEFAULT	5	Land	L-39-D				300,0		
GV	DEFAULT	6	Decelerate			107,0			1 157,0	40,0
GV	DEFAULT	7	Decelerate			20,0			0,0	4,6
HS748A	DEFAULT	1	Descend	ZERO	6 000,0	160,0	3,0			

ACFTID	Profile_ID	Step number	Step type	Flap_ID	Start Altitude (ft)	Start CAS (kt)	Descent Angle (deg)	Touchdown Roll (ft)	Distance (ft)	Start Thrust (% Max thrust)
HS748A	DEFAULT	2	Descend	INTR	3 000,0	110,1	3,0			
HS748A	DEFAULT	3	Descend	D-INTR	1 500,0	100,1	3,0			
HS748A	DEFAULT	4	Descend	D-30	1 000,0	90,1	3,0			
HS748A	DEFAULT	5	Land	D-30				207,0		
HS748A	DEFAULT	6	Decelerate			85,5			1 863,0	40,0
HS748A	DEFAULT	7	Decelerate			30,0			0,0	10,0
IA1125	DEFAULT	1	Descend	ZERO	6 000,0	250,0	3,0			
IA1125	DEFAULT	2	Descend	INTR	3 000,0	152,1	3,0			
IA1125	DEFAULT	3	Descend	D-INTR	1 500,0	142,1	3,0			
IA1125	DEFAULT	4	Descend	D-40	1 000,0	132,1	3,0			
IA1125	DEFAULT	5	Land	D-40				236,6		
IA1125	DEFAULT	6	Decelerate			125,3			2 129,4	40,0
IA1125	DEFAULT	7	Decelerate			30,0			0,0	10,0
L1011	DEFAULT	1	Descend	ZERO	6 000,0	250,0	3,0			
L1011	DEFAULT	2	Descend	10	3 000,0	160,5	3,0			
L1011	DEFAULT	3	Descend	D-33	1 500,0	162,9	3,0			
L1011	DEFAULT	4	Descend	D-42	1 000,0	145,5	3,0			
L1011	DEFAULT	5	Land	D-42				417,0		
L1011	DEFAULT	6	Decelerate			138,1			3 753,0	10,0
L1011	DEFAULT	7	Decelerate			30,0			0,0	10,0
L10115	DEFAULT	1	Descend	ZERO	6 000,0	250,0	3,0			
L10115	DEFAULT	2	Descend	10	3 000,0	162,4	3,0			

ACFTID	Profile_ID	Step number	Step type	Flap_ID	Start Altitude (ft)	Start CAS (kt)	Descent Angle (deg)	Touchdown Roll (ft)	Distance (ft)	Start Thrust (% Max thrust)
L10115	DEFAULT	3	Descend	D-33	1 500,0	151,2	3,0			
L10115	DEFAULT	4	Descend	D-42	1 000,0	147,4	3,0			
L10115	DEFAULT	5	Land	D-42				516,6		
L10115	DEFAULT	6	Decelerate			139,8			4 649,4	10,0
L10115	DEFAULT	7	Decelerate			30,0			0,0	10,0
L188	DEFAULT	1	Descend	ZERO	6 000,0	200,0	3,0			
L188	DEFAULT	2	Descend	INTR	3 000,0	147,5	3,0			
L188	DEFAULT	3	Descend	D-78-%	1 500,0	135,6	3,0			
L188	DEFAULT	4	Descend	D-100	1 000,0	129,8	3,0			
L188	DEFAULT	5	Land	D-100				351,0		
L188	DEFAULT	6	Decelerate			123,1			3 159,0	40,0
L188	DEFAULT	7	Decelerate			30,0			0,0	10,0
LEAR25	DEFAULT	1	Descend	ZERO	6 000,0	250,0	3,0			
LEAR25	DEFAULT	2	Descend	10	3 000,0	161,6	3,0			
LEAR25	DEFAULT	3	Descend	D-INTR	1 500,0	151,6	3,0			
LEAR25	DEFAULT	4	Descend	D-40	1 000,0	141,7	3,0			
LEAR25	DEFAULT	5	Land	D-40				140,4		
LEAR25	DEFAULT	6	Decelerate			134,4			1 263,6	40,0
LEAR25	DEFAULT	7	Decelerate			30,0			0,0	10,0
LEAR35	DEFAULT	1	Descend	ZERO	6 000,0	250,0	3,0			
LEAR35	DEFAULT	2	Descend	10	3 000,0	144,5	3,0			
LEAR35	DEFAULT	3	Descend	D-INTR	1 500,0	134,5	3,0			

ACFTID	Profile_ID	Step number	Step type	Flap_ID	Start Altitude (ft)	Start CAS (kt)	Descent Angle (deg)	Touchdown Roll (ft)	Distance (ft)	Start Thrust (% Max thrust)
LEAR35	DEFAULT	4	Descend	D-40	1 000,0	127,8	3,0			
LEAR35	DEFAULT	5	Land	D-40				181,4		
LEAR35	DEFAULT	6	Decelerate			121,2			1 632,6	40,0
LEAR35	DEFAULT	7	Decelerate			30,0			0,0	10,0
MD9025	DEFAULT	1	Descend	U-0	6 000,0	185,0	3,0			
MD9025	DEFAULT	2	Descend	D-28	3 000,0	154,0	3,0			
MD9025	DEFAULT	3	Descend	D-28	1 500,0	150,0	3,0			
MD9025	DEFAULT	4	Descend	D-40	1 000,0	145,3	3,0			
MD9025	DEFAULT	5	Land	D-40				346,0		
MD9025	DEFAULT	6	Decelerate			130,0			2 100,0	40,0
MD9025	DEFAULT	7	Decelerate			30,0			0,0	9,6
MD9028	DEFAULT	1	Descend	U-0	6 000,0	185,0	3,0			
MD9028	DEFAULT	2	Descend	D-28	3 000,0	154,0	3,0			
MD9028	DEFAULT	3	Descend	D-28	1 500,0	150,0	3,0			
MD9028	DEFAULT	4	Descend	D-40	1 000,0	145,3	3,0			
MD9028	DEFAULT	5	Land	D-40				346,0		
MD9028	DEFAULT	6	Decelerate			130,0			2 100,0	40,0
MD9028	DEFAULT	7	Decelerate			30,0			0,0	8,6
MU3001	DEFAULT	1	Descend	ZERO	6 000,0	250,0	3,0			
MU3001	DEFAULT	2	Descend	1	3 000,0	133,8	3,0			
MU3001	DEFAULT	3	Descend	D-INTR	1 500,0	123,8	3,0			
MU3001	DEFAULT	4	Descend	D-30	1 000,0	117,1	3,0			

ACFTID	Profile_ID	Step number	Step type	Flap_ID	Start Altitude (ft)	Start CAS (kt)	Descent Angle (deg)	Touchdown Roll (ft)	Distance (ft)	Start Thrust (% Max thrust)
MU3001	DEFAULT	5	Land	D-30				156,6		
MU3001	DEFAULT	6	Decelerate			111,1			1 409,4	40,0
MU3001	DEFAULT	7	Decelerate			30,0			0,0	10,0
PA30	DEFAULT	1	Descend	ZERO-A	6 000,0	120,0	3,0			
PA30	DEFAULT	2	Descend	27-A	3 000,0	109,0	3,0			
PA30	DEFAULT	3	Descend	27-A	1 500,0	96,0	3,0			
PA30	DEFAULT	4	Descend	27-A	1 000,0	87,0	3,0			
PA30	DEFAULT	5	Land	27-A				53,5		
PA30	DEFAULT	6	Decelerate			70,0			481,1	10,0
PA30	DEFAULT	7	Decelerate			10,0			0,0	10,0
PA42	DEFAULT	1	Descend	ZERO-A	6 000,0	151,0	3,0			
PA42	DEFAULT	2	Descend	ZERO-A	4 000,0	135,0	3,0			
PA42	DEFAULT	3	Descend	ZERO-A	2 000,0	119,0	3,0			
PA42	DEFAULT	4	Descend	30-DN	1 000,0	111,0	3,0			
PA42	DEFAULT	5	Descend	30-DN	50,0	111,0	3,0			
PA42	DEFAULT	6	Land	30-DN				100,0		
PA42	DEFAULT	7	Decelerate			111,0			2 245,9	10,0
PA42	DEFAULT	8	Decelerate			10,0			0,0	10,0
SD330	DEFAULT	1	Descend	ZERO	6 000,0	160,0	3,0			
SD330	DEFAULT	2	Descend	INTR	3 000,0	120,2	3,0			
SD330	DEFAULT	3	Descend	D-15	1 500,0	106,5	3,0			
SD330	DEFAULT	4	Descend	D-35	1 000,0	100,2	3,0			

ACFTID	Profile_ID	Step number	Step type	Flap_ID	Start Altitude (ft)	Start CAS (kt)	Descent Angle (deg)	Touchdown Roll (ft)	Distance (ft)	Start Thrust (% Max thrust)
SD330	DEFAULT	5	Land	D-35				233,1		
SD330	DEFAULT	6	Decelerate			95,1			2 097,9	40,0
SD330	DEFAULT	7	Decelerate			30,0			0,0	10,0
SF340	DEFAULT	1	Descend	ZERO	6 000,0	160,0	3,0			
SF340	DEFAULT	2	Descend	5	3 000,0	136,9	3,0			
SF340	DEFAULT	3	Descend	D-INTR	1 500,0	126,9	3,0			
SF340	DEFAULT	4	Descend	D-35	1 000,0	116,9	3,0			
SF340	DEFAULT	5	Land	D-35				216,9		
SF340	DEFAULT	6	Decelerate			110,9			1 952,1	40,0
SF340	DEFAULT	7	Decelerate			30,0			0,0	10,0

Table I-4 (part 1)

Default departures procedural steps

ACFTID	Profile_ID	Stage Length	Step Number	Step Type	Thrust Rating	Flap_ID	End Point Altitude (ft)	Rate Of Climb (ft/min)	End Point CAS (kt)	Accelerate_Percent (%)
1900D	DEFAULT	1	1	Takeoff	MaxTakeoff	17-D				
1900D	DEFAULT	1	2	Climb	MaxTakeoff	17-D	400			
1900D	DEFAULT	1	3	Accelerate	MaxTakeoff	17-D		2 750	128	
1900D	DEFAULT	1	4	Accelerate	MaxClimb	ZERO-D		2 950	138	
1900D	DEFAULT	1	5	Climb	MaxClimb	ZERO-D	3 000			
1900D	DEFAULT	1	6	Accelerate	MaxClimb	ZERO-D		1 500	160	
1900D	DEFAULT	1	7	Climb	MaxClimb	ZERO-D	5 500			
1900D	DEFAULT	1	8	Climb	MaxClimb	ZERO-D	7 500			
1900D	DEFAULT	1	9	Climb	MaxClimb	ZERO-D	10 000			

ACFTID	Profile_ID	Stage Length	Step Number	Step Type	Thrust Rating	Flap_ID	End Point Altitude (ft)	Rate Of Climb (ft/min)	End Point CAS (kt)	Accelerate_Percent (%)
1900D	DEFAULT	2	1	Takeoff	MaxTakeoff	17-D				
1900D	DEFAULT	2	2	Climb	MaxTakeoff	17-D	400			
1900D	DEFAULT	2	3	Accelerate	MaxTakeoff	17-D		2 400	128	
1900D	DEFAULT	2	4	Accelerate	MaxClimb	ZERO-D		2 650	138	
1900D	DEFAULT	2	5	Climb	MaxClimb	ZERO-D	3 000			
1900D	DEFAULT	2	6	Accelerate	MaxClimb	ZERO-D		1 500	160	
1900D	DEFAULT	2	7	Climb	MaxClimb	ZERO-D	5 500			
1900D	DEFAULT	2	8	Climb	MaxClimb	ZERO-D	7 500			
1900D	DEFAULT	2	9	Climb	MaxClimb	ZERO-D	10 000			
707320	DEFAULT	1	1	Takeoff	MaxTakeoff	14				
707320	DEFAULT	1	2	Climb	MaxTakeoff	14	1 000			
707320	DEFAULT	1	3	Accelerate	MaxTakeoff	14		2 047	175	
707320	DEFAULT	1	4	Accelerate	MaxClimb	INT		1 000	195	
707320	DEFAULT	1	5	Climb	MaxClimb	ZERO	3 000			
707320	DEFAULT	1	6	Accelerate	MaxClimb	ZERO		1 000	250	
707320	DEFAULT	1	7	Climb	MaxClimb	ZERO	5 500			
707320	DEFAULT	1	8	Climb	MaxClimb	ZERO	7 500			
707320	DEFAULT	1	9	Climb	MaxClimb	ZERO	10 000			
707320	DEFAULT	2	1	Takeoff	MaxTakeoff	14				
707320	DEFAULT	2	2	Climb	MaxTakeoff	14	1 000			

ACFTID	Profile_ID	Stage Length	Step Number	Step Type	Thrust Rating	Flap_ID	End Point Altitude (ft)	Rate Of Climb (ft/min)	End Point CAS (kt)	Accelerate_Percent (%)
707320	DEFAULT	2	3	Accelerate	MaxTakeoff	14		1 905	179	
707320	DEFAULT	2	4	Accelerate	MaxClimb	INT		1 000	199	
707320	DEFAULT	2	5	Climb	MaxClimb	ZERO	3 000			
707320	DEFAULT	2	6	Accelerate	MaxClimb	ZERO		1 000	250	
707320	DEFAULT	2	7	Climb	MaxClimb	ZERO	5 500			
707320	DEFAULT	2	8	Climb	MaxClimb	ZERO	7 500			
707320	DEFAULT	2	9	Climb	MaxClimb	ZERO	10 000			
707320	DEFAULT	3	1	Takeoff	MaxTakeoff	14				
707320	DEFAULT	3	2	Climb	MaxTakeoff	14	1 000			
707320	DEFAULT	3	3	Accelerate	MaxTakeoff	14		1 793	183	
707320	DEFAULT	3	4	Accelerate	MaxClimb	INT		1 000	203	
707320	DEFAULT	3	5	Climb	MaxClimb	ZERO	3 000			
707320	DEFAULT	3	6	Accelerate	MaxClimb	ZERO		1 000	250	
707320	DEFAULT	3	7	Climb	MaxClimb	ZERO	5 500			
707320	DEFAULT	3	8	Climb	MaxClimb	ZERO	7 500			
707320	DEFAULT	3	9	Climb	MaxClimb	ZERO	10 000			
707320	DEFAULT	4	1	Takeoff	MaxTakeoff	14				
707320	DEFAULT	4	2	Climb	MaxTakeoff	14	1 000			
707320	DEFAULT	4	3	Accelerate	MaxTakeoff	14		1 624	189	
707320	DEFAULT	4	4	Accelerate	MaxClimb	INT		1 000	209	

ACFTID	Profile_ID	Stage Length	Step Number	Step Type	Thrust Rating	Flap_ID	End Point Altitude (ft)	Rate Of Climb (ft/min)	End Point CAS (kt)	Accelerate_Percent (%)
707320	DEFAULT	4	5	Climb	MaxClimb	ZERO	3 000			
707320	DEFAULT	4	6	Accelerate	MaxClimb	ZERO		1 000	250	
707320	DEFAULT	4	7	Climb	MaxClimb	ZERO	5 500			
707320	DEFAULT	4	8	Climb	MaxClimb	ZERO	7 500			
707320	DEFAULT	4	9	Climb	MaxClimb	ZERO	10 000			
707320	DEFAULT	5	1	Takeoff	MaxTakeoff	14				
707320	DEFAULT	5	2	Climb	MaxTakeoff	14	1 000			
707320	DEFAULT	5	3	Accelerate	MaxTakeoff	14		1 430	197	
707320	DEFAULT	5	4	Accelerate	MaxClimb	INT		1 000	217	
707320	DEFAULT	5	5	Climb	MaxClimb	ZERO	3 000			
707320	DEFAULT	5	6	Accelerate	MaxClimb	ZERO		1 000	250	
707320	DEFAULT	5	7	Climb	MaxClimb	ZERO	5 500			
707320	DEFAULT	5	8	Climb	MaxClimb	ZERO	7 500			
707320	DEFAULT	5	9	Climb	MaxClimb	ZERO	10 000			
707320	DEFAULT	6	1	Takeoff	MaxTakeoff	14				
707320	DEFAULT	6	2	Climb	MaxTakeoff	14	1 000			
707320	DEFAULT	6	3	Accelerate	MaxTakeoff	14		1 259	205	
707320	DEFAULT	6	4	Accelerate	MaxClimb	INT		800	225	
707320	DEFAULT	6	5	Climb	MaxClimb	ZERO	3 000			
707320	DEFAULT	6	6	Accelerate	MaxClimb	ZERO		800	250	

ACFTID	Profile_ID	Stage Length	Step Number	Step Type	Thrust Rating	Flap_ID	End Point Altitude (ft)	Rate Of Climb (ft/min)	End Point CAS (kt)	Accelerate_Percent (%)
707320	DEFAULT	6	7	Climb	MaxClimb	ZERO	5 500			
707320	DEFAULT	6	8	Climb	MaxClimb	ZERO	7 500			
707320	DEFAULT	6	9	Climb	MaxClimb	ZERO	10 000			
707320	DEFAULT	7	1	Takeoff	MaxTakeoff	14				
707320	DEFAULT	7	2	Climb	MaxTakeoff	14	1 000			
707320	DEFAULT	7	3	Accelerate	MaxTakeoff	14		1 151	209	
707320	DEFAULT	7	4	Accelerate	MaxClimb	INT		800	229	
707320	DEFAULT	7	5	Climb	MaxClimb	ZERO	3 000			
707320	DEFAULT	7	6	Accelerate	MaxClimb	ZERO		800	250	
707320	DEFAULT	7	7	Climb	MaxClimb	ZERO	5 500			
707320	DEFAULT	7	8	Climb	MaxClimb	ZERO	7 500			
707320	DEFAULT	7	9	Climb	MaxClimb	ZERO	10 000			
707QN	DEFAULT	1	1	Takeoff	MaxTakeoff	14				
707QN	DEFAULT	1	2	Climb	MaxTakeoff	14	1 000			
707QN	DEFAULT	1	3	Accelerate	MaxTakeoff	14		2 047	175	
707QN	DEFAULT	1	4	Accelerate	MaxClimb	INT		1 000	195	
707QN	DEFAULT	1	5	Climb	MaxClimb	ZERO	3 000			
707QN	DEFAULT	1	6	Accelerate	MaxClimb	ZERO		1 000	250	
707QN	DEFAULT	1	7	Climb	MaxClimb	ZERO	5 500			
707QN	DEFAULT	1	8	Climb	MaxClimb	ZERO	7 500			

ACFTID	Profile_ID	Stage Length	Step Number	Step Type	Thrust Rating	Flap_ID	End Point Altitude (ft)	Rate Of Climb (ft/min)	End Point CAS (kt)	Accelerate_Percent (%)
707QN	DEFAULT	1	9	Climb	MaxClimb	ZERO	10 000			
707QN	DEFAULT	2	1	Takeoff	MaxTakeoff	14				
707QN	DEFAULT	2	2	Climb	MaxTakeoff	14	1 000			
707QN	DEFAULT	2	3	Accelerate	MaxTakeoff	14		1 905	179	
707QN	DEFAULT	2	4	Accelerate	MaxClimb	INT		1 000	199	
707QN	DEFAULT	2	5	Climb	MaxClimb	ZERO	3 000			
707QN	DEFAULT	2	6	Accelerate	MaxClimb	ZERO		1 000	250	
707QN	DEFAULT	2	7	Climb	MaxClimb	ZERO	5 500			
707QN	DEFAULT	2	8	Climb	MaxClimb	ZERO	7 500			
707QN	DEFAULT	2	9	Climb	MaxClimb	ZERO	10 000			
707QN	DEFAULT	3	1	Takeoff	MaxTakeoff	14				
707QN	DEFAULT	3	2	Climb	MaxTakeoff	14	1 000			
707QN	DEFAULT	3	3	Accelerate	MaxTakeoff	14		1 793	183	
707QN	DEFAULT	3	4	Accelerate	MaxClimb	INT		1 000	203	
707QN	DEFAULT	3	5	Climb	MaxClimb	ZERO	3 000			
707QN	DEFAULT	3	6	Accelerate	MaxClimb	ZERO		1 000	250	
707QN	DEFAULT	3	7	Climb	MaxClimb	ZERO	5 500			
707QN	DEFAULT	3	8	Climb	MaxClimb	ZERO	7 500			
707QN	DEFAULT	3	9	Climb	MaxClimb	ZERO	10 000			
707QN	DEFAULT	4	1	Takeoff	MaxTakeoff	14				

ACFTID	Profile_ID	Stage Length	Step Number	Step Type	Thrust Rating	Flap_ID	End Point Altitude (ft)	Rate Of Climb (ft/min)	End Point CAS (kt)	Accelerate_Percent (%)
707QN	DEFAULT	4	2	Climb	MaxTakeoff	14	1 000			
707QN	DEFAULT	4	3	Accelerate	MaxTakeoff	14		1 624	189	
707QN	DEFAULT	4	4	Accelerate	MaxClimb	INT		1 000	209	
707QN	DEFAULT	4	5	Climb	MaxClimb	ZERO	3 000			
707QN	DEFAULT	4	6	Accelerate	MaxClimb	ZERO		1 000	250	
707QN	DEFAULT	4	7	Climb	MaxClimb	ZERO	5 500			
707QN	DEFAULT	4	8	Climb	MaxClimb	ZERO	7 500			
707QN	DEFAULT	4	9	Climb	MaxClimb	ZERO	10 000			
707QN	DEFAULT	5	1	Takeoff	MaxTakeoff	14				
707QN	DEFAULT	5	2	Climb	MaxTakeoff	14	1 000			
707QN	DEFAULT	5	3	Accelerate	MaxTakeoff	14		1 430	197	
707QN	DEFAULT	5	4	Accelerate	MaxClimb	INT		1 000	217	
707QN	DEFAULT	5	5	Climb	MaxClimb	ZERO	3 000			
707QN	DEFAULT	5	6	Accelerate	MaxClimb	ZERO		1 000	250	
707QN	DEFAULT	5	7	Climb	MaxClimb	ZERO	5 500			
707QN	DEFAULT	5	8	Climb	MaxClimb	ZERO	7 500			
707QN	DEFAULT	5	9	Climb	MaxClimb	ZERO	10 000			
707QN	DEFAULT	6	1	Takeoff	MaxTakeoff	14				
707QN	DEFAULT	6	2	Climb	MaxTakeoff	14	1 000			
707QN	DEFAULT	6	3	Accelerate	MaxTakeoff	14		1 259	205	

ACFTID	Profile_ID	Stage Length	Step Number	Step Type	Thrust Rating	Flap_ID	End Point Altitude (ft)	Rate Of Climb (ft/min)	End Point CAS (kt)	Accelerate_Percent (%)
707QN	DEFAULT	6	4	Accelerate	MaxClimb	INT		800	225	
707QN	DEFAULT	6	5	Climb	MaxClimb	ZERO	3 000			
707QN	DEFAULT	6	6	Accelerate	MaxClimb	ZERO		800	250	
707QN	DEFAULT	6	7	Climb	MaxClimb	ZERO	5 500			
707QN	DEFAULT	6	8	Climb	MaxClimb	ZERO	7 500			
707QN	DEFAULT	6	9	Climb	MaxClimb	ZERO	10 000			
707QN	DEFAULT	7	1	Takeoff	MaxTakeoff	14				
707QN	DEFAULT	7	2	Climb	MaxTakeoff	14	1 000			
707QN	DEFAULT	7	3	Accelerate	MaxTakeoff	14		1 151	209	
707QN	DEFAULT	7	4	Accelerate	MaxClimb	INT		800	229	
707QN	DEFAULT	7	5	Climb	MaxClimb	ZERO	3 000			
707QN	DEFAULT	7	6	Accelerate	MaxClimb	ZERO		800	250	
707QN	DEFAULT	7	7	Climb	MaxClimb	ZERO	5 500			
707QN	DEFAULT	7	8	Climb	MaxClimb	ZERO	7 500			
707QN	DEFAULT	7	9	Climb	MaxClimb	ZERO	10 000			
717200	DEFAULT	1	1	Takeoff	MaxTakeoff	T_13A				
717200	DEFAULT	1	2	Climb	MaxTakeoff	T_13A	1 000			
717200	DEFAULT	1	3	Climb	MaxClimb	T_13A	3 000			
717200	DEFAULT	1	4	Accelerate	MaxClimb	T_00B		1 296,4	250	
717200	DEFAULT	1	5	Climb	MaxClimb	T_00B	5 000			
717200	DEFAULT	1	6	Climb	MaxClimb	T_00B	7 500			

ACFTID	Profile_ID	Stage Length	Step Number	Step Type	Thrust Rating	Flap_ID	End Point Altitude (ft)	Rate Of Climb (ft/min)	End Point CAS (kt)	Accelerate_Percent (%)
717200	DEFAULT	1	7	Climb	MaxClimb	T_00B	10 000			
717200	DEFAULT	2	1	Takeoff	MaxTakeoff	T_13A				
717200	DEFAULT	2	2	Climb	MaxTakeoff	T_13A	1 000			
717200	DEFAULT	2	3	Climb	MaxClimb	T_13A	3 000			
717200	DEFAULT	2	4	Accelerate	MaxClimb	T_00B		1 298	250	
717200	DEFAULT	2	5	Climb	MaxClimb	T_00B	5 000			
717200	DEFAULT	2	6	Climb	MaxClimb	T_00B	7 500			
717200	DEFAULT	2	7	Climb	MaxClimb	T_00B	10 000			
717200	DEFAULT	3	1	Takeoff	MaxTakeoff	T_13A				
717200	DEFAULT	3	2	Climb	MaxTakeoff	T_13A	1 000			
717200	DEFAULT	3	3	Climb	MaxClimb	T_13A	3 000			
717200	DEFAULT	3	4	Accelerate	MaxClimb	T_00B		1 229,1	250	
717200	DEFAULT	3	5	Climb	MaxClimb	T_00B	5 000			
717200	DEFAULT	3	6	Climb	MaxClimb	T_00B	7 500			
717200	DEFAULT	3	7	Climb	MaxClimb	T_00B	10 000			
717200	DEFAULT	4	1	Takeoff	MaxTakeoff	T_13A				
717200	DEFAULT	4	2	Climb	MaxTakeoff	T_13A	1 000			
717200	DEFAULT	4	3	Climb	MaxClimb	T_13A	3 000			
717200	DEFAULT	4	4	Accelerate	MaxClimb	T_00B		1 165,9	250	
717200	DEFAULT	4	5	Climb	MaxClimb	T_00B	5 000			
717200	DEFAULT	4	6	Climb	MaxClimb	T_00B	7 500			

ACFTID	Profile_ID	Stage Length	Step Number	Step Type	Thrust Rating	Flap_ID	End Point Altitude (ft)	Rate Of Climb (ft/min)	End Point CAS (kt)	Accelerate_Percent (%)
717200	DEFAULT	4	7	Climb	MaxClimb	T_00B	10 000			
717200	DEFAULT	5	1	Takeoff	MaxTakeoff	T_13A				
717200	DEFAULT	5	2	Climb	MaxTakeoff	T_13A	1 000			
717200	DEFAULT	5	3	Climb	MaxClimb	T_13A	3 000			
717200	DEFAULT	5	4	Accelerate	MaxClimb	T_00B		1 142,6	250	
717200	DEFAULT	5	5	Climb	MaxClimb	T_00B	5 000			
717200	DEFAULT	5	6	Climb	MaxClimb	T_00B	7 500			
717200	DEFAULT	5	7	Climb	MaxClimb	T_00B	10 000			
717200	DEFAULT	6	1	Takeoff	MaxTakeoff	T_13A				
717200	DEFAULT	6	2	Climb	MaxTakeoff	T_13A	1 000			
717200	DEFAULT	6	3	Climb	MaxClimb	T_13A	3 000			
717200	DEFAULT	6	4	Accelerate	MaxClimb	T_00B		1 098,3	250	
717200	DEFAULT	6	5	Climb	MaxClimb	T_00B	5 000			
717200	DEFAULT	6	6	Climb	MaxClimb	T_00B	7 500			
717200	DEFAULT	6	7	Climb	MaxClimb	T_00B	10 000			
717200	ICAO_B	1	1	Takeoff	MaxTakeoff	T_13A				
717200	ICAO_B	1	2	Climb	MaxTakeoff	T_13A	1 100			
717200	ICAO_B	1	3	Accelerate	MaxTakeoff	T_13A		2 137,1	186,2	
717200	ICAO_B	1	4	Climb	MaxClimb	T_00B	3 000			
717200	ICAO_B	1	5	Accelerate	MaxClimb	T_00B		1 000	250	

ACFTID	Profile_ID	Stage Length	Step Number	Step Type	Thrust Rating	Flap_ID	End Point Altitude (ft)	Rate Of Climb (ft/min)	End Point CAS (kt)	Accelerate_Percent (%)
717200	ICAO_B	1	6	Climb	MaxClimb	T_00B	5 500			
717200	ICAO_B	1	7	Climb	MaxClimb	T_00B	7 500			
717200	ICAO_B	1	8	Climb	MaxClimb	T_00B	10 000			
717200	ICAO_B	2	1	Takeoff	MaxTakeoff	T_13A				
717200	ICAO_B	2	2	Climb	MaxTakeoff	T_13A	1 000			
717200	ICAO_B	2	3	Accelerate	MaxTakeoff	T_13A		2 003,2	185	
717200	ICAO_B	2	4	Climb	MaxClimb	T_00B	3 000			
717200	ICAO_B	2	5	Accelerate	MaxClimb	T_00B		1 000	250	
717200	ICAO_B	2	6	Climb	MaxClimb	T_00B	5 500			
717200	ICAO_B	2	7	Climb	MaxClimb	T_00B	7 500			
717200	ICAO_B	2	8	Climb	MaxClimb	T_00B	10 000			
717200	ICAO_B	3	1	Takeoff	MaxTakeoff	T_13A				
717200	ICAO_B	3	2	Climb	MaxTakeoff	T_13A	1 000			
717200	ICAO_B	3	3	Accelerate	MaxTakeoff	T_13A		1 874,4	183,8	
717200	ICAO_B	3	4	Climb	MaxClimb	T_00B	3 000			
717200	ICAO_B	3	5	Accelerate	MaxClimb	T_00B		1 000	250	
717200	ICAO_B	3	6	Climb	MaxClimb	T_00B	5 500			
717200	ICAO_B	3	7	Climb	MaxClimb	T_00B	7 500			
717200	ICAO_B	3	8	Climb	MaxClimb	T_00B	10 000			
717200	ICAO_B	4	1	Takeoff	MaxTakeoff	T_13A				

ACFTID	Profile_ID	Stage Length	Step Number	Step Type	Thrust Rating	Flap_ID	End Point Altitude (ft)	Rate Of Climb (ft/min)	End Point CAS (kt)	Accelerate_Percent (%)
717200	ICAO_B	4	2	Climb	MaxTakeoff	T_13A	1 000			
717200	ICAO_B	4	3	Accelerate	MaxTakeoff	T_13A		1 756,2	182,7	
717200	ICAO_B	4	4	Climb	MaxClimb	T_00B	3 000			
717200	ICAO_B	4	5	Accelerate	MaxClimb	T_00B		1 000	250	
717200	ICAO_B	4	6	Climb	MaxClimb	T_00B	5 500			
717200	ICAO_B	4	7	Climb	MaxClimb	T_00B	7 500			
717200	ICAO_B	4	8	Climb	MaxClimb	T_00B	10 000			
717200	ICAO_B	5	1	Takeoff	MaxTakeoff	T_13A				
717200	ICAO_B	5	2	Climb	MaxTakeoff	T_13A	1 000			
717200	ICAO_B	5	3	Accelerate	MaxTakeoff	T_13A		1 705,9	192,7	
717200	ICAO_B	5	4	Climb	MaxClimb	T_00B	3 000			
717200	ICAO_B	5	5	Accelerate	MaxClimb	T_00B		1 000	250	
717200	ICAO_B	5	6	Climb	MaxClimb	T_00B	5 500			
717200	ICAO_B	5	7	Climb	MaxClimb	T_00B	7 500			
717200	ICAO_B	5	8	Climb	MaxClimb	T_00B	10 000			
717200	ICAO_B	6	1	Takeoff	MaxTakeoff	T_13A				
717200	ICAO_B	6	2	Climb	MaxTakeoff	T_13A	1 000			
717200	ICAO_B	6	3	Accelerate	MaxTakeoff	T_13A		1 540,3	191,2	
717200	ICAO_B	6	4	Climb	MaxClimb	T_00B	3 000			
717200	ICAO_B	6	5	Accelerate	MaxClimb	T_00B		1 000	250	

ACFTID	Profile_ID	Stage Length	Step Number	Step Type	Thrust Rating	Flap_ID	End Point Altitude (ft)	Rate Of Climb (ft/min)	End Point CAS (kt)	Accelerate_Percent (%)
717200	ICAO_B	6	6	Climb	MaxClimb	T_00B	5 500			
717200	ICAO_B	6	7	Climb	MaxClimb	T_00B	7 500			
717200	ICAO_B	6	8	Climb	MaxClimb	T_00B	10 000			
720B	DEFAULT	1	1	Takeoff	MaxTakeoff	20				
720B	DEFAULT	1	2	Climb	MaxTakeoff	20	1 000			
720B	DEFAULT	1	3	Accelerate	MaxTakeoff	20		2 632	175	
720B	DEFAULT	1	4	Accelerate	MaxClimb	INT		1 000	195	
720B	DEFAULT	1	5	Climb	MaxClimb	ZERO	3 000			
720B	DEFAULT	1	6	Accelerate	MaxClimb	ZERO		1 000	250	
720B	DEFAULT	1	7	Climb	MaxClimb	ZERO	5 500			
720B	DEFAULT	1	8	Climb	MaxClimb	ZERO	7 500			
720B	DEFAULT	1	9	Climb	MaxClimb	ZERO	10 000			
720B	DEFAULT	2	1	Takeoff	MaxTakeoff	20				
720B	DEFAULT	2	2	Climb	MaxTakeoff	20	1 000			
720B	DEFAULT	2	3	Accelerate	MaxTakeoff	20		2 470	179	
720B	DEFAULT	2	4	Accelerate	MaxClimb	INT		1 000	199	
720B	DEFAULT	2	5	Climb	MaxClimb	ZERO	3 000			
720B	DEFAULT	2	6	Accelerate	MaxClimb	ZERO		1 000	250	
720B	DEFAULT	2	7	Climb	MaxClimb	ZERO	5 500			
720B	DEFAULT	2	8	Climb	MaxClimb	ZERO	7 500			

ACFTID	Profile_ID	Stage Length	Step Number	Step Type	Thrust Rating	Flap_ID	End Point Altitude (ft)	Rate Of Climb (ft/min)	End Point CAS (kt)	Accelerate_Percent (%)
720B	DEFAULT	2	9	Climb	MaxClimb	ZERO	10 000			
720B	DEFAULT	3	1	Takeoff	MaxTakeoff	20				
720B	DEFAULT	3	2	Climb	MaxTakeoff	20	1 000			
720B	DEFAULT	3	3	Accelerate	MaxTakeoff	20		2 323	183	
720B	DEFAULT	3	4	Accelerate	MaxClimb	INT		1 000	203	
720B	DEFAULT	3	5	Climb	MaxClimb	ZERO	3 000			
720B	DEFAULT	3	6	Accelerate	MaxClimb	ZERO		1 000	250	
720B	DEFAULT	3	7	Climb	MaxClimb	ZERO	5 500			
720B	DEFAULT	3	8	Climb	MaxClimb	ZERO	7 500			
720B	DEFAULT	3	9	Climb	MaxClimb	ZERO	10 000			
720B	DEFAULT	4	1	Takeoff	MaxTakeoff	20				
720B	DEFAULT	4	2	Climb	MaxTakeoff	20	1 000			
720B	DEFAULT	4	3	Accelerate	MaxTakeoff	20		2 125	189	
720B	DEFAULT	4	4	Accelerate	MaxClimb	INT		1 000	209	
720B	DEFAULT	4	5	Climb	MaxClimb	ZERO	3 000			
720B	DEFAULT	4	6	Accelerate	MaxClimb	ZERO		1 000	250	
720B	DEFAULT	4	7	Climb	MaxClimb	ZERO	5 500			
720B	DEFAULT	4	8	Climb	MaxClimb	ZERO	7 500			
720B	DEFAULT	4	9	Climb	MaxClimb	ZERO	10 000			
720B	DEFAULT	5	1	Takeoff	MaxTakeoff	20				

ACFTID	Profile_ID	Stage Length	Step Number	Step Type	Thrust Rating	Flap_ID	End Point Altitude (ft)	Rate Of Climb (ft/min)	End Point CAS (kt)	Accelerate_Percent (%)
720B	DEFAULT	5	2	Climb	MaxTakeoff	20	1 000			
720B	DEFAULT	5	3	Accelerate	MaxTakeoff	20		2 005	193	
720B	DEFAULT	5	4	Accelerate	MaxClimb	INT		1 000	213	
720B	DEFAULT	5	5	Climb	MaxClimb	ZERO	3 000			
720B	DEFAULT	5	6	Accelerate	MaxClimb	ZERO		1 000	250	
720B	DEFAULT	5	7	Climb	MaxClimb	ZERO	5 500			
720B	DEFAULT	5	8	Climb	MaxClimb	ZERO	7 500			
720B	DEFAULT	5	9	Climb	MaxClimb	ZERO	10 000			
727100	DEFAULT	1	1	Takeoff	MaxTakeoff	5				
727100	DEFAULT	1	2	Climb	MaxTakeoff	5	1 000			
727100	DEFAULT	1	3	Accelerate	MaxTakeoff	5		1 342	160	
727100	DEFAULT	1	4	Accelerate	MaxTakeoff	2		1 342	190	
727100	DEFAULT	1	5	Accelerate	MaxClimb	ZERO		1 000	200	
727100	DEFAULT	1	6	Climb	MaxClimb	ZERO	3 000			
727100	DEFAULT	1	7	Accelerate	MaxClimb	ZERO		1 000	250	
727100	DEFAULT	1	8	Climb	MaxClimb	ZERO	5 500			
727100	DEFAULT	1	9	Climb	MaxClimb	ZERO	7 500			
727100	DEFAULT	1	10	Climb	MaxClimb	ZERO	10 000			
727100	DEFAULT	2	1	Takeoff	MaxTakeoff	5				
727100	DEFAULT	2	2	Climb	MaxTakeoff	5	1 000			

ACFTID	Profile_ID	Stage Length	Step Number	Step Type	Thrust Rating	Flap_ID	End Point Altitude (ft)	Rate Of Climb (ft/min)	End Point CAS (kt)	Accelerate_Percent (%)
727100	DEFAULT	2	3	Accelerate	MaxTakeoff	5		1 265	160	
727100	DEFAULT	2	4	Accelerate	MaxTakeoff	2		1 265	190	
727100	DEFAULT	2	5	Accelerate	MaxClimb	ZERO		1 000	200	
727100	DEFAULT	2	6	Climb	MaxClimb	ZERO	3 000			
727100	DEFAULT	2	7	Accelerate	MaxClimb	ZERO		1 000	250	
727100	DEFAULT	2	8	Climb	MaxClimb	ZERO	5 500			
727100	DEFAULT	2	9	Climb	MaxClimb	ZERO	7 500			
727100	DEFAULT	2	10	Climb	MaxClimb	ZERO	10 000			
727100	DEFAULT	3	1	Takeoff	MaxTakeoff	5				
727100	DEFAULT	3	2	Climb	MaxTakeoff	5	1 000			
727100	DEFAULT	3	3	Accelerate	MaxTakeoff	5		1 192	165	
727100	DEFAULT	3	4	Accelerate	MaxTakeoff	2		1 192	195	
727100	DEFAULT	3	5	Accelerate	MaxClimb	ZERO		1 000	205	
727100	DEFAULT	3	6	Climb	MaxClimb	ZERO	3 000			
727100	DEFAULT	3	7	Accelerate	MaxClimb	ZERO		1 000	250	
727100	DEFAULT	3	8	Climb	MaxClimb	ZERO	5 500			
727100	DEFAULT	3	9	Climb	MaxClimb	ZERO	7 500			
727100	DEFAULT	3	10	Climb	MaxClimb	ZERO	10 000			
727100	DEFAULT	4	1	Takeoff	MaxTakeoff	5				
727100	DEFAULT	4	2	Climb	MaxTakeoff	5	1 000			

ACFTID	Profile_ID	Stage Length	Step Number	Step Type	Thrust Rating	Flap_ID	End Point Altitude (ft)	Rate Of Climb (ft/min)	End Point CAS (kt)	Accelerate_Percent (%)
727100	DEFAULT	4	3	Accelerate	MaxTakeoff	5		1 115	170	
727100	DEFAULT	4	4	Accelerate	MaxTakeoff	2		1 115	200	
727100	DEFAULT	4	5	Accelerate	MaxClimb	ZERO		1 000	210	
727100	DEFAULT	4	6	Climb	MaxClimb	ZERO	3 000			
727100	DEFAULT	4	7	Accelerate	MaxClimb	ZERO		1 000	250	
727100	DEFAULT	4	8	Climb	MaxClimb	ZERO	5 500			
727100	DEFAULT	4	9	Climb	MaxClimb	ZERO	7 500			
727100	DEFAULT	4	10	Climb	MaxClimb	ZERO	10 000			
727D15	DEFAULT	1	1	Takeoff	MaxTakeoff	5				
727D15	DEFAULT	1	2	Climb	MaxTakeoff	5	1 000			
727D15	DEFAULT	1	3	Accelerate	MaxTakeoff	5		1 363	170	
727D15	DEFAULT	1	4	Accelerate	MaxTakeoff	2		1 363	200	
727D15	DEFAULT	1	5	Accelerate	MaxClimb	ZERO		1 000	210	
727D15	DEFAULT	1	6	Climb	MaxClimb	ZERO	3 000			
727D15	DEFAULT	1	7	Accelerate	MaxClimb	ZERO		1 000	250	
727D15	DEFAULT	1	8	Climb	MaxClimb	ZERO	5 500			
727D15	DEFAULT	1	9	Climb	MaxClimb	ZERO	7 500			
727D15	DEFAULT	1	10	Climb	MaxClimb	ZERO	10 000			
727D15	DEFAULT	2	1	Takeoff	MaxTakeoff	5				
727D15	DEFAULT	2	2	Climb	MaxTakeoff	5	1 000			

ACFTID	Profile_ID	Stage Length	Step Number	Step Type	Thrust Rating	Flap_ID	End Point Altitude (ft)	Rate Of Climb (ft/min)	End Point CAS (kt)	Accelerate_Percent (%)
727D15	DEFAULT	2	3	Accelerate	MaxTakeoff	5		1 281	170	
727D15	DEFAULT	2	4	Accelerate	MaxTakeoff	2		1 281	200	
727D15	DEFAULT	2	5	Accelerate	MaxClimb	ZERO		1 000	210	
727D15	DEFAULT	2	6	Climb	MaxClimb	ZERO	3 000			
727D15	DEFAULT	2	7	Accelerate	MaxClimb	ZERO		1 000	250	
727D15	DEFAULT	2	8	Climb	MaxClimb	ZERO	5 500			
727D15	DEFAULT	2	9	Climb	MaxClimb	ZERO	7 500			
727D15	DEFAULT	2	10	Climb	MaxClimb	ZERO	10 000			
727D15	DEFAULT	3	1	Takeoff	MaxTakeoff	5				
727D15	DEFAULT	3	2	Climb	MaxTakeoff	5	1 000			
727D15	DEFAULT	3	3	Accelerate	MaxTakeoff	5		1 177	175	
727D15	DEFAULT	3	4	Accelerate	MaxTakeoff	2		1 177	205	
727D15	DEFAULT	3	5	Accelerate	MaxClimb	ZERO		1 000	215	
727D15	DEFAULT	3	6	Climb	MaxClimb	ZERO	3 000			
727D15	DEFAULT	3	7	Accelerate	MaxClimb	ZERO		1 000	250	
727D15	DEFAULT	3	8	Climb	MaxClimb	ZERO	5 500			
727D15	DEFAULT	3	9	Climb	MaxClimb	ZERO	7 500			
727D15	DEFAULT	3	10	Climb	MaxClimb	ZERO	10 000			
727D15	DEFAULT	4	1	Takeoff	MaxTakeoff	5				
727D15	DEFAULT	4	2	Climb	MaxTakeoff	5	1 000			

ACFTID	Profile_ID	Stage Length	Step Number	Step Type	Thrust Rating	Flap_ID	End Point Altitude (ft)	Rate Of Climb (ft/min)	End Point CAS (kt)	Accelerate_Percent (%)
727D15	DEFAULT	4	3	Accelerate	MaxTakeoff	5		1 057	180	
727D15	DEFAULT	4	4	Accelerate	MaxTakeoff	2		1 057	210	
727D15	DEFAULT	4	5	Accelerate	MaxClimb	ZERO		1 000	220	
727D15	DEFAULT	4	6	Climb	MaxClimb	ZERO	3 000			
727D15	DEFAULT	4	7	Accelerate	MaxClimb	ZERO		1 000	250	
727D15	DEFAULT	4	8	Climb	MaxClimb	ZERO	5 500			
727D15	DEFAULT	4	9	Climb	MaxClimb	ZERO	7 500			
727D15	DEFAULT	4	10	Climb	MaxClimb	ZERO	10 000			
727D15	DEFAULT	5	1	Takeoff	MaxTakeoff	5				
727D15	DEFAULT	5	2	Climb	MaxTakeoff	5	1 000			
727D15	DEFAULT	5	3	Accelerate	MaxTakeoff	2		941	210	
727D15	DEFAULT	5	4	Accelerate	MaxClimb	ZERO		1 000	220	
727D15	DEFAULT	5	5	Climb	MaxClimb	ZERO	3 000			
727D15	DEFAULT	5	6	Accelerate	MaxClimb	ZERO		1 000	250	
727D15	DEFAULT	5	7	Climb	MaxClimb	ZERO	5 500			
727D15	DEFAULT	5	8	Climb	MaxClimb	ZERO	7 500			
727D15	DEFAULT	5	9	Climb	MaxClimb	ZERO	10 000			
727D17	DEFAULT	1	1	Takeoff	MaxTakeoff	5				
727D17	DEFAULT	1	2	Climb	MaxTakeoff	5	1 000			
727D17	DEFAULT	1	3	Accelerate	MaxTakeoff	5		1 465	170	

ACFTID	Profile_ID	Stage Length	Step Number	Step Type	Thrust Rating	Flap_ID	End Point Altitude (ft)	Rate Of Climb (ft/min)	End Point CAS (kt)	Accelerate_Percent (%)
727D17	DEFAULT	1	4	Accelerate	MaxTakeoff	2		1 465	200	
727D17	DEFAULT	1	5	Accelerate	MaxClimb	ZERO		1 000	210	
727D17	DEFAULT	1	6	Climb	MaxClimb	ZERO	3 000			
727D17	DEFAULT	1	7	Accelerate	MaxClimb	ZERO		1 000	250	
727D17	DEFAULT	1	8	Climb	MaxClimb	ZERO	5 500			
727D17	DEFAULT	1	9	Climb	MaxClimb	ZERO	7 500			
727D17	DEFAULT	1	10	Climb	MaxClimb	ZERO	10 000			
727D17	DEFAULT	2	1	Takeoff	MaxTakeoff	5				
727D17	DEFAULT	2	2	Climb	MaxTakeoff	5	1 000			
727D17	DEFAULT	2	3	Accelerate	MaxTakeoff	5		1 340	175	
727D17	DEFAULT	2	4	Accelerate	MaxTakeoff	2		1 340	205	
727D17	DEFAULT	2	5	Accelerate	MaxClimb	ZERO		1 000	215	
727D17	DEFAULT	2	6	Climb	MaxClimb	ZERO	3 000			
727D17	DEFAULT	2	7	Accelerate	MaxClimb	ZERO		1 000	250	
727D17	DEFAULT	2	8	Climb	MaxClimb	ZERO	5 500			
727D17	DEFAULT	2	9	Climb	MaxClimb	ZERO	7 500			
727D17	DEFAULT	2	10	Climb	MaxClimb	ZERO	10 000			
727D17	DEFAULT	3	1	Takeoff	MaxTakeoff	5				
727D17	DEFAULT	3	2	Climb	MaxTakeoff	5	1 000			
727D17	DEFAULT	3	3	Accelerate	MaxTakeoff	5		1 236	180	

ACFTID	Profile_ID	Stage Length	Step Number	Step Type	Thrust Rating	Flap_ID	End Point Altitude (ft)	Rate Of Climb (ft/min)	End Point CAS (kt)	Accelerate_Percent (%)
727D17	DEFAULT	3	4	Accelerate	MaxTakeoff	2		1 236	210	
727D17	DEFAULT	3	5	Accelerate	MaxClimb	ZERO		1 000	220	
727D17	DEFAULT	3	6	Climb	MaxClimb	ZERO	3 000			
727D17	DEFAULT	3	7	Accelerate	MaxClimb	ZERO		1 000	250	
727D17	DEFAULT	3	8	Climb	MaxClimb	ZERO	5 500			
727D17	DEFAULT	3	9	Climb	MaxClimb	ZERO	7 500			
727D17	DEFAULT	3	10	Climb	MaxClimb	ZERO	10 000			
727D17	DEFAULT	4	1	Takeoff	MaxTakeoff	5				
727D17	DEFAULT	4	2	Climb	MaxTakeoff	5	1 000			
727D17	DEFAULT	4	3	Accelerate	MaxTakeoff	5		1 158	180	
727D17	DEFAULT	4	4	Accelerate	MaxTakeoff	2		1 158	210	
727D17	DEFAULT	4	5	Accelerate	MaxClimb	ZERO		1 000	220	
727D17	DEFAULT	4	6	Climb	MaxClimb	ZERO	3 000			
727D17	DEFAULT	4	7	Accelerate	MaxClimb	ZERO		1 000	250	
727D17	DEFAULT	4	8	Climb	MaxClimb	ZERO	5 500			
727D17	DEFAULT	4	9	Climb	MaxClimb	ZERO	7 500			
727D17	DEFAULT	4	10	Climb	MaxClimb	ZERO	10 000			
727EM1	DEFAULT	1	1	Takeoff	MaxTakeoff	5				
727EM1	DEFAULT	1	2	Climb	MaxTakeoff	5	1 000			
727EM1	DEFAULT	1	3	Accelerate	MaxTakeoff	5		1 342	160	

ACFTID	Profile_ID	Stage Length	Step Number	Step Type	Thrust Rating	Flap_ID	End Point Altitude (ft)	Rate Of Climb (ft/min)	End Point CAS (kt)	Accelerate_Percent (%)
727EM1	DEFAULT	1	4	Accelerate	MaxTakeoff	2		1 342	190	
727EM1	DEFAULT	1	5	Accelerate	MaxClimb	ZERO		1 000	200	
727EM1	DEFAULT	1	6	Climb	MaxClimb	ZERO	3 000			
727EM1	DEFAULT	1	7	Accelerate	MaxClimb	ZERO		1 000	250	
727EM1	DEFAULT	1	8	Climb	MaxClimb	ZERO	5 500			
727EM1	DEFAULT	1	9	Climb	MaxClimb	ZERO	7 500			
727EM1	DEFAULT	1	10	Climb	MaxClimb	ZERO	10 000			
727EM1	DEFAULT	2	1	Takeoff	MaxTakeoff	5				
727EM1	DEFAULT	2	2	Climb	MaxTakeoff	5	1 000			
727EM1	DEFAULT	2	3	Accelerate	MaxTakeoff	5		1 265	160	
727EM1	DEFAULT	2	4	Accelerate	MaxTakeoff	2		1 265	190	
727EM1	DEFAULT	2	5	Accelerate	MaxClimb	ZERO		1 000	200	
727EM1	DEFAULT	2	6	Climb	MaxClimb	ZERO	3 000			
727EM1	DEFAULT	2	7	Accelerate	MaxClimb	ZERO		1 000	250	
727EM1	DEFAULT	2	8	Climb	MaxClimb	ZERO	5 500			
727EM1	DEFAULT	2	9	Climb	MaxClimb	ZERO	7 500			
727EM1	DEFAULT	2	10	Climb	MaxClimb	ZERO	10 000			
727EM1	DEFAULT	3	1	Takeoff	MaxTakeoff	5				
727EM1	DEFAULT	3	2	Climb	MaxTakeoff	5	1 000			
727EM1	DEFAULT	3	3	Accelerate	MaxTakeoff	5		1 192	165	

ACFTID	Profile_ID	Stage Length	Step Number	Step Type	Thrust Rating	Flap_ID	End Point Altitude (ft)	Rate Of Climb (ft/min)	End Point CAS (kt)	Accelerate_Percent (%)
727EM1	DEFAULT	3	4	Accelerate	MaxTakeoff	2		1 192	195	
727EM1	DEFAULT	3	5	Accelerate	MaxClimb	ZERO		1 000	205	
727EM1	DEFAULT	3	6	Climb	MaxClimb	ZERO	3 000			
727EM1	DEFAULT	3	7	Accelerate	MaxClimb	ZERO		1 000	250	
727EM1	DEFAULT	3	8	Climb	MaxClimb	ZERO	5 500			
727EM1	DEFAULT	3	9	Climb	MaxClimb	ZERO	7 500			
727EM1	DEFAULT	3	10	Climb	MaxClimb	ZERO	10 000			
727EM1	DEFAULT	4	1	Takeoff	MaxTakeoff	5				
727EM1	DEFAULT	4	2	Climb	MaxTakeoff	5	1 000			
727EM1	DEFAULT	4	3	Accelerate	MaxTakeoff	5		1 115	170	
727EM1	DEFAULT	4	4	Accelerate	MaxTakeoff	2		1 115	200	
727EM1	DEFAULT	4	5	Accelerate	MaxClimb	ZERO		1 000	210	
727EM1	DEFAULT	4	6	Climb	MaxClimb	ZERO	3 000			
727EM1	DEFAULT	4	7	Accelerate	MaxClimb	ZERO		1 000	250	
727EM1	DEFAULT	4	8	Climb	MaxClimb	ZERO	5 500			
727EM1	DEFAULT	4	9	Climb	MaxClimb	ZERO	7 500			
727EM1	DEFAULT	4	10	Climb	MaxClimb	ZERO	10 000			
727EM2	DEFAULT	1	1	Takeoff	MaxTakeoff	5				
727EM2	DEFAULT	1	2	Climb	MaxTakeoff	5	1 000			
727EM2	DEFAULT	1	3	Accelerate	MaxTakeoff	5		1 363	170	

ACFTID	Profile_ID	Stage Length	Step Number	Step Type	Thrust Rating	Flap_ID	End Point Altitude (ft)	Rate Of Climb (ft/min)	End Point CAS (kt)	Accelerate_Percent (%)
727EM2	DEFAULT	1	4	Accelerate	MaxTakeoff	2		1 363	200	
727EM2	DEFAULT	1	5	Accelerate	MaxClimb	ZERO		1 000	210	
727EM2	DEFAULT	1	6	Climb	MaxClimb	ZERO	3 000			
727EM2	DEFAULT	1	7	Accelerate	MaxClimb	ZERO		1 000	250	
727EM2	DEFAULT	1	8	Climb	MaxClimb	ZERO	5 500			
727EM2	DEFAULT	1	9	Climb	MaxClimb	ZERO	7 500			
727EM2	DEFAULT	1	10	Climb	MaxClimb	ZERO	10 000			
727EM2	DEFAULT	2	1	Takeoff	MaxTakeoff	5				
727EM2	DEFAULT	2	2	Climb	MaxTakeoff	5	1 000			
727EM2	DEFAULT	2	3	Accelerate	MaxTakeoff	5		1 281	170	
727EM2	DEFAULT	2	4	Accelerate	MaxTakeoff	2		1 281	200	
727EM2	DEFAULT	2	5	Accelerate	MaxClimb	ZERO		1 000	210	
727EM2	DEFAULT	2	6	Climb	MaxClimb	ZERO	3 000			
727EM2	DEFAULT	2	7	Accelerate	MaxClimb	ZERO		1 000	250	
727EM2	DEFAULT	2	8	Climb	MaxClimb	ZERO	5 500			
727EM2	DEFAULT	2	9	Climb	MaxClimb	ZERO	7 500			
727EM2	DEFAULT	2	10	Climb	MaxClimb	ZERO	10 000			
727EM2	DEFAULT	3	1	Takeoff	MaxTakeoff	5				
727EM2	DEFAULT	3	2	Climb	MaxTakeoff	5	1 000			
727EM2	DEFAULT	3	3	Accelerate	MaxTakeoff	5		1 177	175	

ACFTID	Profile_ID	Stage Length	Step Number	Step Type	Thrust Rating	Flap_ID	End Point Altitude (ft)	Rate Of Climb (ft/min)	End Point CAS (kt)	Accelerate_Percent (%)
727EM2	DEFAULT	3	4	Accelerate	MaxTakeoff	2		1 177	205	
727EM2	DEFAULT	3	5	Accelerate	MaxClimb	ZERO		1 000	215	
727EM2	DEFAULT	3	6	Climb	MaxClimb	ZERO	3 000			
727EM2	DEFAULT	3	7	Accelerate	MaxClimb	ZERO		1 000	250	
727EM2	DEFAULT	3	8	Climb	MaxClimb	ZERO	5 500			
727EM2	DEFAULT	3	9	Climb	MaxClimb	ZERO	7 500			
727EM2	DEFAULT	3	10	Climb	MaxClimb	ZERO	10 000			
727EM2	DEFAULT	4	1	Takeoff	MaxTakeoff	5				
727EM2	DEFAULT	4	2	Climb	MaxTakeoff	5	1 000			
727EM2	DEFAULT	4	3	Accelerate	MaxTakeoff	5		1 057	180	
727EM2	DEFAULT	4	4	Accelerate	MaxTakeoff	2		1 057	210	
727EM2	DEFAULT	4	5	Accelerate	MaxClimb	ZERO		1 000	220	
727EM2	DEFAULT	4	6	Climb	MaxClimb	ZERO	3 000			
727EM2	DEFAULT	4	7	Accelerate	MaxClimb	ZERO		1 000	250	
727EM2	DEFAULT	4	8	Climb	MaxClimb	ZERO	5 500			
727EM2	DEFAULT	4	9	Climb	MaxClimb	ZERO	7 500			
727EM2	DEFAULT	4	10	Climb	MaxClimb	ZERO	10 000			
727EM2	DEFAULT	5	1	Takeoff	MaxTakeoff	5				
727EM2	DEFAULT	5	2	Climb	MaxTakeoff	5	1 000			
727EM2	DEFAULT	5	3	Accelerate	MaxTakeoff	2		941	210	

ACFTID	Profile_ID	Stage Length	Step Number	Step Type	Thrust Rating	Flap_ID	End Point Altitude (ft)	Rate Of Climb (ft/min)	End Point CAS (kt)	Accelerate_Percent (%)
727EM2	DEFAULT	5	4	Accelerate	MaxClimb	ZERO		1 000	220	
727EM2	DEFAULT	5	5	Climb	MaxClimb	ZERO	3 000			
727EM2	DEFAULT	5	6	Accelerate	MaxClimb	ZERO		1 000	250	
727EM2	DEFAULT	5	7	Climb	MaxClimb	ZERO	5 500			
727EM2	DEFAULT	5	8	Climb	MaxClimb	ZERO	7 500			
727EM2	DEFAULT	5	9	Climb	MaxClimb	ZERO	10 000			
727Q15	DEFAULT	1	1	Takeoff	MaxTakeoff	5				
727Q15	DEFAULT	1	2	Climb	MaxTakeoff	5	1 000			
727Q15	DEFAULT	1	3	Accelerate	MaxTakeoff	5		1 363	170	
727Q15	DEFAULT	1	4	Accelerate	MaxTakeoff	2		1 363	200	
727Q15	DEFAULT	1	5	Accelerate	MaxClimb	ZERO		1 000	210	
727Q15	DEFAULT	1	6	Climb	MaxClimb	ZERO	3 000			
727Q15	DEFAULT	1	7	Accelerate	MaxClimb	ZERO		1 000	250	
727Q15	DEFAULT	1	8	Climb	MaxClimb	ZERO	5 500			
727Q15	DEFAULT	1	9	Climb	MaxClimb	ZERO	7 500			
727Q15	DEFAULT	1	10	Climb	MaxClimb	ZERO	10 000			
727Q15	DEFAULT	2	1	Takeoff	MaxTakeoff	5				
727Q15	DEFAULT	2	2	Climb	MaxTakeoff	5	1 000			
727Q15	DEFAULT	2	3	Accelerate	MaxTakeoff	5		1 281	170	
727Q15	DEFAULT	2	4	Accelerate	MaxTakeoff	2		1 281	200	

ACFTID	Profile_ID	Stage Length	Step Number	Step Type	Thrust Rating	Flap_ID	End Point Altitude (ft)	Rate Of Climb (ft/min)	End Point CAS (kt)	Accelerate_Percent (%)
727Q15	DEFAULT	2	5	Accelerate	MaxClimb	ZERO		1 000	210	
727Q15	DEFAULT	2	6	Climb	MaxClimb	ZERO	3 000			
727Q15	DEFAULT	2	7	Accelerate	MaxClimb	ZERO		1 000	250	
727Q15	DEFAULT	2	8	Climb	MaxClimb	ZERO	5 500			
727Q15	DEFAULT	2	9	Climb	MaxClimb	ZERO	7 500			
727Q15	DEFAULT	2	10	Climb	MaxClimb	ZERO	10 000			
727Q15	DEFAULT	3	1	Takeoff	MaxTakeoff	5				
727Q15	DEFAULT	3	2	Climb	MaxTakeoff	5	1 000			
727Q15	DEFAULT	3	3	Accelerate	MaxTakeoff	5		1 177	175	
727Q15	DEFAULT	3	4	Accelerate	MaxTakeoff	2		1 177	205	
727Q15	DEFAULT	3	5	Accelerate	MaxClimb	ZERO		1 000	215	
727Q15	DEFAULT	3	6	Climb	MaxClimb	ZERO	3 000			
727Q15	DEFAULT	3	7	Accelerate	MaxClimb	ZERO		1 000	250	
727Q15	DEFAULT	3	8	Climb	MaxClimb	ZERO	5 500			
727Q15	DEFAULT	3	9	Climb	MaxClimb	ZERO	7 500			
727Q15	DEFAULT	3	10	Climb	MaxClimb	ZERO	10 000			
727Q15	DEFAULT	4	1	Takeoff	MaxTakeoff	5				
727Q15	DEFAULT	4	2	Climb	MaxTakeoff	5	1 000			
727Q15	DEFAULT	4	3	Accelerate	MaxTakeoff	5		1 057	180	
727Q15	DEFAULT	4	4	Accelerate	MaxTakeoff	2		1 057	210	

ACFTID	Profile_ID	Stage Length	Step Number	Step Type	Thrust Rating	Flap_ID	End Point Altitude (ft)	Rate Of Climb (ft/min)	End Point CAS (kt)	Accelerate_Percent (%)
727Q15	DEFAULT	4	5	Accelerate	MaxClimb	ZERO		1 000	220	
727Q15	DEFAULT	4	6	Climb	MaxClimb	ZERO	3 000			
727Q15	DEFAULT	4	7	Accelerate	MaxClimb	ZERO		1 000	250	
727Q15	DEFAULT	4	8	Climb	MaxClimb	ZERO	5 500			
727Q15	DEFAULT	4	9	Climb	MaxClimb	ZERO	7 500			
727Q15	DEFAULT	4	10	Climb	MaxClimb	ZERO	10 000			
727Q15	DEFAULT	5	1	Takeoff	MaxTakeoff	5				
727Q15	DEFAULT	5	2	Climb	MaxTakeoff	5	1 000			
727Q15	DEFAULT	5	3	Accelerate	MaxTakeoff	2		941	210	
727Q15	DEFAULT	5	4	Accelerate	MaxClimb	ZERO		1 000	220	
727Q15	DEFAULT	5	5	Climb	MaxClimb	ZERO	3 000			
727Q15	DEFAULT	5	6	Accelerate	MaxClimb	ZERO		1 000	250	
727Q15	DEFAULT	5	7	Climb	MaxClimb	ZERO	5 500			
727Q15	DEFAULT	5	8	Climb	MaxClimb	ZERO	7 500			
727Q15	DEFAULT	5	9	Climb	MaxClimb	ZERO	10 000			
727Q7	DEFAULT	1	1	Takeoff	MaxTakeoff	5				
727Q7	DEFAULT	1	2	Climb	MaxTakeoff	5	1 000			
727Q7	DEFAULT	1	3	Accelerate	MaxTakeoff	5		1 342	160	
727Q7	DEFAULT	1	4	Accelerate	MaxTakeoff	2		1 342	190	
727Q7	DEFAULT	1	5	Accelerate	MaxClimb	ZERO		1 000	200	

ACFTID	Profile_ID	Stage Length	Step Number	Step Type	Thrust Rating	Flap_ID	End Point Altitude (ft)	Rate Of Climb (ft/min)	End Point CAS (kt)	Accelerate_Percent (%)
727Q7	DEFAULT	1	6	Climb	MaxClimb	ZERO	3 000			
727Q7	DEFAULT	1	7	Accelerate	MaxClimb	ZERO		1 000	250	
727Q7	DEFAULT	1	8	Climb	MaxClimb	ZERO	5 500			
727Q7	DEFAULT	1	9	Climb	MaxClimb	ZERO	7 500			
727Q7	DEFAULT	1	10	Climb	MaxClimb	ZERO	10 000			
727Q7	DEFAULT	2	1	Takeoff	MaxTakeoff	5				
727Q7	DEFAULT	2	2	Climb	MaxTakeoff	5	1 000			
727Q7	DEFAULT	2	3	Accelerate	MaxTakeoff	5		1 265	160	
727Q7	DEFAULT	2	4	Accelerate	MaxTakeoff	2		1 265	190	
727Q7	DEFAULT	2	5	Accelerate	MaxClimb	ZERO		1 000	200	
727Q7	DEFAULT	2	6	Climb	MaxClimb	ZERO	3 000			
727Q7	DEFAULT	2	7	Accelerate	MaxClimb	ZERO		1 000	250	
727Q7	DEFAULT	2	8	Climb	MaxClimb	ZERO	5 500			
727Q7	DEFAULT	2	9	Climb	MaxClimb	ZERO	7 500			
727Q7	DEFAULT	2	10	Climb	MaxClimb	ZERO	10 000			
727Q7	DEFAULT	3	1	Takeoff	MaxTakeoff	5				
727Q7	DEFAULT	3	2	Climb	MaxTakeoff	5	1 000			
727Q7	DEFAULT	3	3	Accelerate	MaxTakeoff	5		1 192	165	
727Q7	DEFAULT	3	4	Accelerate	MaxTakeoff	2		1 192	195	
727Q7	DEFAULT	3	5	Accelerate	MaxClimb	ZERO		1 000	205	

ACFTID	Profile_ID	Stage Length	Step Number	Step Type	Thrust Rating	Flap_ID	End Point Altitude (ft)	Rate Of Climb (ft/min)	End Point CAS (kt)	Accelerate_Percent (%)
727Q7	DEFAULT	3	6	Climb	MaxClimb	ZERO	3 000			
727Q7	DEFAULT	3	7	Accelerate	MaxClimb	ZERO		1 000	250	
727Q7	DEFAULT	3	8	Climb	MaxClimb	ZERO	5 500			
727Q7	DEFAULT	3	9	Climb	MaxClimb	ZERO	7 500			
727Q7	DEFAULT	3	10	Climb	MaxClimb	ZERO	10 000			
727Q7	DEFAULT	4	1	Takeoff	MaxTakeoff	5				
727Q7	DEFAULT	4	2	Climb	MaxTakeoff	5	1 000			
727Q7	DEFAULT	4	3	Accelerate	MaxTakeoff	5		1 115	170	
727Q7	DEFAULT	4	4	Accelerate	MaxTakeoff	2		1 115	200	
727Q7	DEFAULT	4	5	Accelerate	MaxClimb	ZERO		1 000	210	
727Q7	DEFAULT	4	6	Climb	MaxClimb	ZERO	3 000			
727Q7	DEFAULT	4	7	Accelerate	MaxClimb	ZERO		1 000	250	
727Q7	DEFAULT	4	8	Climb	MaxClimb	ZERO	5 500			
727Q7	DEFAULT	4	9	Climb	MaxClimb	ZERO	7 500			
727Q7	DEFAULT	4	10	Climb	MaxClimb	ZERO	10 000			
727Q9	DEFAULT	1	1	Takeoff	MaxTakeoff	5				
727Q9	DEFAULT	1	2	Climb	MaxTakeoff	5	1 000			
727Q9	DEFAULT	1	3	Accelerate	MaxTakeoff	5		1 539	170	
727Q9	DEFAULT	1	4	Accelerate	MaxTakeoff	2		1 539	200	
727Q9	DEFAULT	1	5	Accelerate	MaxClimb	ZERO		1 000	210	

ACFTID	Profile_ID	Stage Length	Step Number	Step Type	Thrust Rating	Flap_ID	End Point Altitude (ft)	Rate Of Climb (ft/min)	End Point CAS (kt)	Accelerate_Percent (%)
727Q9	DEFAULT	1	6	Climb	MaxClimb	ZERO	3 000			
727Q9	DEFAULT	1	7	Accelerate	MaxClimb	ZERO		1 000	250	
727Q9	DEFAULT	1	8	Climb	MaxClimb	ZERO	5 500			
727Q9	DEFAULT	1	9	Climb	MaxClimb	ZERO	7 500			
727Q9	DEFAULT	1	10	Climb	MaxClimb	ZERO	10 000			
727Q9	DEFAULT	2	1	Takeoff	MaxTakeoff	5				
727Q9	DEFAULT	2	2	Climb	MaxTakeoff	5	1 000			
727Q9	DEFAULT	2	3	Accelerate	MaxTakeoff	5		1 390	170	
727Q9	DEFAULT	2	4	Accelerate	MaxTakeoff	2		1 390	200	
727Q9	DEFAULT	2	5	Accelerate	MaxClimb	ZERO		1 000	210	
727Q9	DEFAULT	2	6	Climb	MaxClimb	ZERO	3 000			
727Q9	DEFAULT	2	7	Accelerate	MaxClimb	ZERO		1 000	250	
727Q9	DEFAULT	2	8	Climb	MaxClimb	ZERO	5 500			
727Q9	DEFAULT	2	9	Climb	MaxClimb	ZERO	7 500			
727Q9	DEFAULT	2	10	Climb	MaxClimb	ZERO	10 000			
727Q9	DEFAULT	3	1	Takeoff	MaxTakeoff	5				
727Q9	DEFAULT	3	2	Climb	MaxTakeoff	5	1 000			
727Q9	DEFAULT	3	3	Accelerate	MaxTakeoff	5		1 255	180	
727Q9	DEFAULT	3	4	Accelerate	MaxTakeoff	2		1 255	210	
727Q9	DEFAULT	3	5	Accelerate	MaxClimb	ZERO		1 000	220	

ACFTID	Profile_ID	Stage Length	Step Number	Step Type	Thrust Rating	Flap_ID	End Point Altitude (ft)	Rate Of Climb (ft/min)	End Point CAS (kt)	Accelerate_Percent (%)
727Q9	DEFAULT	3	6	Climb	MaxClimb	ZERO	3 000			
727Q9	DEFAULT	3	7	Accelerate	MaxClimb	ZERO		1 000	250	
727Q9	DEFAULT	3	8	Climb	MaxClimb	ZERO	5 500			
727Q9	DEFAULT	3	9	Climb	MaxClimb	ZERO	7 500			
727Q9	DEFAULT	3	10	Climb	MaxClimb	ZERO	10 000			
727Q9	DEFAULT	4	1	Takeoff	MaxTakeoff	5				
727Q9	DEFAULT	4	2	Climb	MaxTakeoff	5	1 000			
727Q9	DEFAULT	4	3	Accelerate	MaxTakeoff	2		855	210	
727Q9	DEFAULT	4	4	Accelerate	MaxClimb	ZERO		1 000	220	
727Q9	DEFAULT	4	5	Climb	MaxClimb	ZERO	3 000			
727Q9	DEFAULT	4	6	Accelerate	MaxClimb	ZERO		1 000	250	
727Q9	DEFAULT	4	7	Climb	MaxClimb	ZERO	5 500			
727Q9	DEFAULT	4	8	Climb	MaxClimb	ZERO	7 500			
727Q9	DEFAULT	4	9	Climb	MaxClimb	ZERO	10 000			
727QF	DEFAULT	1	1	Takeoff	MaxTakeoff	5				
727QF	DEFAULT	1	2	Climb	MaxTakeoff	5	1 000			
727QF	DEFAULT	1	3	Accelerate	MaxTakeoff	5		1 000	175	
727QF	DEFAULT	1	4	Accelerate	MaxTakeoff	2		1 000	190	
727QF	DEFAULT	1	5	Accelerate	MaxTakeoff	ZERO		1 000	200	
727QF	DEFAULT	1	6	Climb	MaxContinuous	ZERO	3 000			

ACFTID	Profile_ID	Stage Length	Step Number	Step Type	Thrust Rating	Flap_ID	End Point Altitude (ft)	Rate Of Climb (ft/min)	End Point CAS (kt)	Accelerate_Percent (%)
727QF	DEFAULT	1	7	Accelerate	MaxContinuous	ZERO		1 000	250	
727QF	DEFAULT	1	8	Climb	MaxClimb	ZERO	5 500			
727QF	DEFAULT	1	9	Climb	MaxClimb	ZERO	7 500			
727QF	DEFAULT	1	10	Climb	MaxClimb	ZERO	10 000			
727QF	DEFAULT	2	1	Takeoff	MaxTakeoff	5				
727QF	DEFAULT	2	2	Climb	MaxTakeoff	5	1 000			
727QF	DEFAULT	2	3	Accelerate	MaxTakeoff	5		1 000	180	
727QF	DEFAULT	2	4	Accelerate	MaxTakeoff	2		1 000	190	
727QF	DEFAULT	2	5	Accelerate	MaxTakeoff	ZERO		1 000	200	
727QF	DEFAULT	2	6	Climb	MaxContinuous	ZERO	3 000			
727QF	DEFAULT	2	7	Accelerate	MaxContinuous	ZERO		1 000	250	
727QF	DEFAULT	2	8	Climb	MaxClimb	ZERO	5 500			
727QF	DEFAULT	2	9	Climb	MaxClimb	ZERO	7 500			
727QF	DEFAULT	2	10	Climb	MaxClimb	ZERO	10 000			
727QF	DEFAULT	3	1	Takeoff	MaxTakeoff	5				
727QF	DEFAULT	3	2	Climb	MaxTakeoff	5	1 000			
727QF	DEFAULT	3	3	Accelerate	MaxTakeoff	5		1 000	184	
727QF	DEFAULT	3	4	Accelerate	MaxTakeoff	2		1 000	190	
727QF	DEFAULT	3	5	Accelerate	MaxTakeoff	ZERO		1 000	200	
727QF	DEFAULT	3	6	Climb	MaxContinuous	ZERO	3 000			

ACFTID	Profile_ID	Stage Length	Step Number	Step Type	Thrust Rating	Flap_ID	End Point Altitude (ft)	Rate Of Climb (ft/min)	End Point CAS (kt)	Accelerate_Percent (%)
727QF	DEFAULT	3	7	Accelerate	MaxContinuous	ZERO		1 000	250	
727QF	DEFAULT	3	8	Climb	MaxClimb	ZERO	5 500			
727QF	DEFAULT	3	9	Climb	MaxClimb	ZERO	7 500			
727QF	DEFAULT	3	10	Climb	MaxClimb	ZERO	10 000			
727QF	DEFAULT	4	1	Takeoff	MaxTakeoff	5				
727QF	DEFAULT	4	2	Climb	MaxTakeoff	5	1 000			
727QF	DEFAULT	4	3	Accelerate	MaxTakeoff	5		1 000	189	
727QF	DEFAULT	4	4	Accelerate	MaxTakeoff	2		1 000	190	
727QF	DEFAULT	4	5	Accelerate	MaxTakeoff	ZERO		1 000	200	
727QF	DEFAULT	4	6	Climb	MaxContinuous	ZERO	3 000			
727QF	DEFAULT	4	7	Accelerate	MaxContinuous	ZERO		1 000	250	
727QF	DEFAULT	4	8	Climb	MaxClimb	ZERO	5 500			
727QF	DEFAULT	4	9	Climb	MaxClimb	ZERO	7 500			
727QF	DEFAULT	4	10	Climb	MaxClimb	ZERO	10 000			
737	DEFAULT	1	1	Takeoff	MaxTakeoff	5				
737	DEFAULT	1	2	Climb	MaxTakeoff	5	1 000			
737	DEFAULT	1	3	Accelerate	MaxTakeoff	5		2 090	146	
737	DEFAULT	1	4	Accelerate	MaxTakeoff	INT		1 568	171	
737	DEFAULT	1	5	Accelerate	MaxClimb	ZERO		1 000	210	
737	DEFAULT	1	6	Climb	MaxClimb	ZERO	3 000			

ACFTID	Profile_ID	Stage Length	Step Number	Step Type	Thrust Rating	Flap_ID	End Point Altitude (ft)	Rate Of Climb (ft/min)	End Point CAS (kt)	Accelerate_Percent (%)
737	DEFAULT	1	7	Accelerate	MaxClimb	ZERO		1 000	250	
737	DEFAULT	1	8	Climb	MaxClimb	ZERO	5 500			
737	DEFAULT	1	9	Climb	MaxClimb	ZERO	7 500			
737	DEFAULT	1	10	Climb	MaxClimb	ZERO	10 000			
737	DEFAULT	2	1	Takeoff	MaxTakeoff	5				
737	DEFAULT	2	2	Climb	MaxTakeoff	5	1 000			
737	DEFAULT	2	3	Accelerate	MaxTakeoff	5		2 014	149	
737	DEFAULT	2	4	Accelerate	MaxTakeoff	INT		1 511	174	
737	DEFAULT	2	5	Accelerate	MaxClimb	ZERO		1 000	210	
737	DEFAULT	2	6	Climb	MaxClimb	ZERO	3 000			
737	DEFAULT	2	7	Accelerate	MaxClimb	ZERO		1 000	250	
737	DEFAULT	2	8	Climb	MaxClimb	ZERO	5 500			
737	DEFAULT	2	9	Climb	MaxClimb	ZERO	7 500			
737	DEFAULT	2	10	Climb	MaxClimb	ZERO	10 000			
737	DEFAULT	3	1	Takeoff	MaxTakeoff	5				
737	DEFAULT	3	2	Climb	MaxTakeoff	5	1 000			
737	DEFAULT	3	3	Accelerate	MaxTakeoff	5		1 851	154	
737	DEFAULT	3	4	Accelerate	MaxTakeoff	INT		1 388	179	
737	DEFAULT	3	5	Accelerate	MaxClimb	ZERO		1 000	210	
737	DEFAULT	3	6	Climb	MaxClimb	ZERO	3 000			

ACFTID	Profile_ID	Stage Length	Step Number	Step Type	Thrust Rating	Flap_ID	End Point Altitude (ft)	Rate Of Climb (ft/min)	End Point CAS (kt)	Accelerate_Percent (%)
737	DEFAULT	3	7	Accelerate	MaxClimb	ZERO		1 000	250	
737	DEFAULT	3	8	Climb	MaxClimb	ZERO	5 500			
737	DEFAULT	3	9	Climb	MaxClimb	ZERO	7 500			
737	DEFAULT	3	10	Climb	MaxClimb	ZERO	10 000			
737	DEFAULT	4	1	Takeoff	MaxTakeoff	5				
737	DEFAULT	4	2	Climb	MaxTakeoff	5	1 000			
737	DEFAULT	4	3	Accelerate	MaxTakeoff	5		1 685	160	
737	DEFAULT	4	4	Accelerate	MaxTakeoff	INT		1 264	185	
737	DEFAULT	4	5	Accelerate	MaxClimb	ZERO		1 000	210	
737	DEFAULT	4	6	Climb	MaxClimb	ZERO	3 000			
737	DEFAULT	4	7	Accelerate	MaxClimb	ZERO		1 000	250	
737	DEFAULT	4	8	Climb	MaxClimb	ZERO	5 500			
737	DEFAULT	4	9	Climb	MaxClimb	ZERO	7 500			
737	DEFAULT	4	10	Climb	MaxClimb	ZERO	10 000			
737300	DEFAULT	1	1	Takeoff	MaxTakeoff	5				
737300	DEFAULT	1	2	Climb	MaxTakeoff	5	1 000			
737300	DEFAULT	1	3	Accelerate	MaxClimb	5		1 483,4	187,9	
737300	DEFAULT	1	4	Accelerate	MaxClimb	1		1 684,6	205,5	
737300	DEFAULT	1	5	Accelerate	MaxClimb	ZERO		1 815,6	220,5	
737300	DEFAULT	1	6	Climb	MaxClimb	ZERO	3 000			

ACFTID	Profile_ID	Stage Length	Step Number	Step Type	Thrust Rating	Flap_ID	End Point Altitude (ft)	Rate Of Climb (ft/min)	End Point CAS (kt)	Accelerate_Percent (%)
737300	DEFAULT	1	7	Accelerate	MaxClimb	ZERO		1 892,6	250	
737300	DEFAULT	1	8	Climb	MaxClimb	ZERO	5 500			
737300	DEFAULT	1	9	Climb	MaxClimb	ZERO	7 500			
737300	DEFAULT	1	10	Climb	MaxClimb	ZERO	10 000			
737300	DEFAULT	2	1	Takeoff	MaxTakeoff	5				
737300	DEFAULT	2	2	Climb	MaxTakeoff	5	1 000			
737300	DEFAULT	2	3	Accelerate	MaxClimb	5		1 398,8	189,2	
737300	DEFAULT	2	4	Accelerate	MaxClimb	1		1 579,3	204,5	
737300	DEFAULT	2	5	Accelerate	MaxClimb	ZERO		1 700,5	220,5	
737300	DEFAULT	2	6	Climb	MaxClimb	ZERO	3 000			
737300	DEFAULT	2	7	Accelerate	MaxClimb	ZERO		1 774,1	250	
737300	DEFAULT	2	8	Climb	MaxClimb	ZERO	5 500			
737300	DEFAULT	2	9	Climb	MaxClimb	ZERO	7 500			
737300	DEFAULT	2	10	Climb	MaxClimb	ZERO	10 000			
737300	DEFAULT	3	1	Takeoff	MaxTakeoff	5				
737300	DEFAULT	3	2	Climb	MaxTakeoff	5	1 000			
737300	DEFAULT	3	3	Accelerate	MaxClimb	5		1 311,5	190,8	
737300	DEFAULT	3	4	Accelerate	MaxClimb	1		1 487,2	213,2	
737300	DEFAULT	3	5	Accelerate	MaxClimb	ZERO		1 609,4	220,5	
737300	DEFAULT	3	6	Climb	MaxClimb	ZERO	3 000			

ACFTID	Profile_ID	Stage Length	Step Number	Step Type	Thrust Rating	Flap_ID	End Point Altitude (ft)	Rate Of Climb (ft/min)	End Point CAS (kt)	Accelerate_Percent (%)
737300	DEFAULT	3	7	Accelerate	MaxClimb	ZERO		1 657,6	250	
737300	DEFAULT	3	8	Climb	MaxClimb	ZERO	5 500			
737300	DEFAULT	3	9	Climb	MaxClimb	ZERO	7 500			
737300	DEFAULT	3	10	Climb	MaxClimb	ZERO	10 000			
737300	DEFAULT	4	1	Takeoff	MaxTakeoff	5				
737300	DEFAULT	4	2	Climb	MaxTakeoff	5	1 000			
737300	DEFAULT	4	3	Accelerate	MaxClimb	5		1 154,7	194,6	
737300	DEFAULT	4	4	Accelerate	MaxClimb	1		1 295,8	211,5	
737300	DEFAULT	4	5	Accelerate	MaxClimb	ZERO		1 391,6	220,5	
737300	DEFAULT	4	6	Climb	MaxClimb	ZERO	3 000			
737300	DEFAULT	4	7	Accelerate	MaxClimb	ZERO		1 444,8	250	
737300	DEFAULT	4	8	Climb	MaxClimb	ZERO	5 500			
737300	DEFAULT	4	9	Climb	MaxClimb	ZERO	7 500			
737300	DEFAULT	4	10	Climb	MaxClimb	ZERO	10 000			
737300	ICAO_A	1	1	Takeoff	MaxTakeoff	5				
737300	ICAO_A	1	2	Climb	MaxTakeoff	5	1 500			
737300	ICAO_A	1	3	Climb	MaxClimb	5	3 000			
737300	ICAO_A	1	4	Accelerate	MaxClimb	5		1 413,5	184,9	
737300	ICAO_A	1	5	Accelerate	MaxClimb	1		1 601,4	203,9	
737300	ICAO_A	1	6	Accelerate	MaxClimb	ZERO		1 821,6	250	

ACFTID	Profile_ID	Stage Length	Step Number	Step Type	Thrust Rating	Flap_ID	End Point Altitude (ft)	Rate Of Climb (ft/min)	End Point CAS (kt)	Accelerate_Percent (%)
737300	ICAO_A	1	7	Climb	MaxClimb	ZERO	5 500			
737300	ICAO_A	1	8	Climb	MaxClimb	ZERO	7 500			
737300	ICAO_A	1	9	Climb	MaxClimb	ZERO	10 000			
737300	ICAO_A	2	1	Takeoff	MaxTakeoff	5				
737300	ICAO_A	2	2	Climb	MaxTakeoff	5	1 500			
737300	ICAO_A	2	3	Climb	MaxClimb	5	3 000			
737300	ICAO_A	2	4	Accelerate	MaxClimb	5	1 332,5	186,4		
737300	ICAO_A	2	5	Accelerate	MaxClimb	1	1 497,1	203		
737300	ICAO_A	2	6	Accelerate	MaxClimb	ZERO	1 705,6	250		
737300	ICAO_A	2	7	Climb	MaxClimb	ZERO	5 500			
737300	ICAO_A	2	8	Climb	MaxClimb	ZERO	7 500			
737300	ICAO_A	2	9	Climb	MaxClimb	ZERO	10 000			
737300	ICAO_A	3	1	Takeoff	MaxTakeoff	5				
737300	ICAO_A	3	2	Climb	MaxTakeoff	5	1 500			
737300	ICAO_A	3	3	Climb	MaxClimb	5	3 000			
737300	ICAO_A	3	4	Accelerate	MaxClimb	5	1 247,9	188,2		
737300	ICAO_A	3	5	Accelerate	MaxClimb	1	1 415,3	211,7		
737300	ICAO_A	3	6	Accelerate	MaxClimb	ZERO	1 609,9	250		
737300	ICAO_A	3	7	Climb	MaxClimb	ZERO	5 500			
737300	ICAO_A	3	8	Climb	MaxClimb	ZERO	7 500			

ACFTID	Profile_ID	Stage Length	Step Number	Step Type	Thrust Rating	Flap_ID	End Point Altitude (ft)	Rate Of Climb (ft/min)	End Point CAS (kt)	Accelerate_Percent (%)
737300	ICAO_A	3	9	Climb	MaxClimb	ZERO	10 000			
737300	ICAO_A	4	1	Takeoff	MaxTakeoff	5				
737300	ICAO_A	4	2	Climb	MaxTakeoff	5	1 500			
737300	ICAO_A	4	3	Climb	MaxClimb	5	3 000			
737300	ICAO_A	4	4	Accelerate	MaxClimb	5		1 093,3	192,2	
737300	ICAO_A	4	5	Accelerate	MaxClimb	1		1 223,7	210,2	
737300	ICAO_A	4	6	Accelerate	MaxClimb	ZERO		1 399,1	250	
737300	ICAO_A	4	7	Climb	MaxClimb	ZERO	5 500			
737300	ICAO_A	4	8	Climb	MaxClimb	ZERO	7 500			
737300	ICAO_A	4	9	Climb	MaxClimb	ZERO	10 000			
737300	ICAO_B	1	1	Takeoff	MaxTakeoff	5				
737300	ICAO_B	1	2	Climb	MaxTakeoff	5	1 000			
737300	ICAO_B	1	3	Accelerate	MaxTakeoff	5		1 560,7	189,3	
737300	ICAO_B	1	4	Accelerate	MaxTakeoff	1		1 765,5	206,2	
737300	ICAO_B	1	5	Accelerate	MaxTakeoff	ZERO		1 897	220,5	
737300	ICAO_B	1	6	Climb	MaxClimb	ZERO	3 000			
737300	ICAO_B	1	7	Accelerate	MaxClimb	ZERO		1 892,6	250	
737300	ICAO_B	1	8	Climb	MaxClimb	ZERO	5 500			
737300	ICAO_B	1	9	Climb	MaxClimb	ZERO	7 500			
737300	ICAO_B	1	10	Climb	MaxClimb	ZERO	10 000			

ACFTID	Profile_ID	Stage Length	Step Number	Step Type	Thrust Rating	Flap_ID	End Point Altitude (ft)	Rate Of Climb (ft/min)	End Point CAS (kt)	Accelerate_Percent (%)
737300	ICAO_B	2	1	Takeoff	MaxTakeoff	5				
737300	ICAO_B	2	2	Climb	MaxTakeoff	5	1 000			
737300	ICAO_B	2	3	Accelerate	MaxTakeoff	5		1 468,7	190,5	
737300	ICAO_B	2	4	Accelerate	MaxTakeoff	1		1 652,2	205,8	
737300	ICAO_B	2	5	Accelerate	MaxTakeoff	ZERO		1 773,2	220,5	
737300	ICAO_B	2	6	Climb	MaxClimb	ZERO	3 000			
737300	ICAO_B	2	7	Accelerate	MaxClimb	ZERO		1 773,3	250	
737300	ICAO_B	2	8	Climb	MaxClimb	ZERO	5 500			
737300	ICAO_B	2	9	Climb	MaxClimb	ZERO	7 500			
737300	ICAO_B	2	10	Climb	MaxClimb	ZERO	10 000			
737300	ICAO_B	3	1	Takeoff	MaxTakeoff	5				
737300	ICAO_B	3	2	Climb	MaxTakeoff	5	1 000			
737300	ICAO_B	3	3	Accelerate	MaxTakeoff	5		1 380,4	192,1	
737300	ICAO_B	3	4	Accelerate	MaxTakeoff	1		1 557,4	213,8	
737300	ICAO_B	3	5	Accelerate	MaxTakeoff	ZERO		1 688,1	220,5	
737300	ICAO_B	3	6	Climb	MaxClimb	ZERO	3 000			
737300	ICAO_B	3	7	Accelerate	MaxClimb	ZERO		1 657,6	250	
737300	ICAO_B	3	8	Climb	MaxClimb	ZERO	5 500			
737300	ICAO_B	3	9	Climb	MaxClimb	ZERO	7 500			
737300	ICAO_B	3	10	Climb	MaxClimb	ZERO	10 000			

ACFTID	Profile_ID	Stage Length	Step Number	Step Type	Thrust Rating	Flap_ID	End Point Altitude (ft)	Rate Of Climb (ft/min)	End Point CAS (kt)	Accelerate_Percent (%)
737300	ICAO_B	4	1	Takeoff	MaxTakeoff	5				
737300	ICAO_B	4	2	Climb	MaxTakeoff	5	1 000			
737300	ICAO_B	4	3	Accelerate	MaxTakeoff	5		1 217,8	195,7	
737300	ICAO_B	4	4	Accelerate	MaxTakeoff	1		1 361,4	212	
737300	ICAO_B	4	5	Accelerate	MaxTakeoff	ZERO		1 457,6	220,5	
737300	ICAO_B	4	6	Climb	MaxClimb	ZERO	3 000			
737300	ICAO_B	4	7	Accelerate	MaxClimb	ZERO		1 444,8	250	
737300	ICAO_B	4	8	Climb	MaxClimb	ZERO	5 500			
737300	ICAO_B	4	9	Climb	MaxClimb	ZERO	7 500			
737300	ICAO_B	4	10	Climb	MaxClimb	ZERO	10 000			
7373B2	DEFAULT	1	1	Takeoff	MaxTakeoff	5				
7373B2	DEFAULT	1	2	Climb	MaxTakeoff	5	1 000			
7373B2	DEFAULT	1	3	Accelerate	MaxClimb	T_05		1 671,2	191,9	
7373B2	DEFAULT	1	4	Accelerate	MaxClimb	T_01		1 900	209,1	
7373B2	DEFAULT	1	5	Climb	MaxClimb	ZERO	3 000			
7373B2	DEFAULT	1	6	Accelerate	MaxClimb	ZERO		2 058,2	250	
7373B2	DEFAULT	1	7	Climb	MaxClimb	ZERO	5 500			
7373B2	DEFAULT	1	8	Climb	MaxClimb	ZERO	7 500			
7373B2	DEFAULT	1	9	Climb	MaxClimb	ZERO	10 000			
7373B2	DEFAULT	2	1	Takeoff	MaxTakeoff	5				

ACFTID	Profile_ID	Stage Length	Step Number	Step Type	Thrust Rating	Flap_ID	End Point Altitude (ft)	Rate Of Climb (ft/min)	End Point CAS (kt)	Accelerate_Percent (%)
7373B2	DEFAULT	2	2	Climb	MaxTakeoff	5	1 000			
7373B2	DEFAULT	2	3	Accelerate	MaxClimb	T_05		1 575,5	192,6	
7373B2	DEFAULT	2	4	Accelerate	MaxClimb	T_01		1 786	208,8	
7373B2	DEFAULT	2	5	Climb	MaxClimb	ZERO	3 000			
7373B2	DEFAULT	2	6	Accelerate	MaxClimb	ZERO		1 934,6	250	
7373B2	DEFAULT	2	7	Climb	MaxClimb	ZERO	5 500			
7373B2	DEFAULT	2	8	Climb	MaxClimb	ZERO	7 500			
7373B2	DEFAULT	2	9	Climb	MaxClimb	ZERO	10 000			
7373B2	DEFAULT	3	1	Takeoff	MaxTakeoff	5				
7373B2	DEFAULT	3	2	Climb	MaxTakeoff	5	1 000			
7373B2	DEFAULT	3	3	Accelerate	MaxClimb	T_05		1 483,2	194	
7373B2	DEFAULT	3	4	Accelerate	MaxClimb	T_01		1 675,9	215,3	
7373B2	DEFAULT	3	5	Climb	MaxClimb	ZERO	3 000			
7373B2	DEFAULT	3	6	Accelerate	MaxClimb	ZERO		1 828,7	250	
7373B2	DEFAULT	3	7	Climb	MaxClimb	ZERO	5 500			
7373B2	DEFAULT	3	8	Climb	MaxClimb	ZERO	7 500			
7373B2	DEFAULT	3	9	Climb	MaxClimb	ZERO	10 000			
7373B2	DEFAULT	4	1	Takeoff	MaxTakeoff	5				
7373B2	DEFAULT	4	2	Climb	MaxTakeoff	5	1 000			
7373B2	DEFAULT	4	3	Accelerate	MaxClimb	T_05		1 314,1	197,8	

ACFTID	Profile_ID	Stage Length	Step Number	Step Type	Thrust Rating	Flap_ID	End Point Altitude (ft)	Rate Of Climb (ft/min)	End Point CAS (kt)	Accelerate_Percent (%)
7373B2	DEFAULT	4	4	Accelerate	MaxClimb	T_01		1 478,4	213,5	
7373B2	DEFAULT	4	5	Climb	MaxClimb	ZERO	3 000			
7373B2	DEFAULT	4	6	Accelerate	MaxClimb	ZERO		1 597,8	250	
7373B2	DEFAULT	4	7	Climb	MaxClimb	ZERO	5 500			
7373B2	DEFAULT	4	8	Climb	MaxClimb	ZERO	7 500			
7373B2	DEFAULT	4	9	Climb	MaxClimb	ZERO	10 000			
7373B2	DEFAULT	M	1	Takeoff	MaxTakeoff	5				
7373B2	DEFAULT	M	2	Climb	MaxTakeoff	5	1 000			
7373B2	DEFAULT	M	3	Accelerate	MaxClimb	T_05		1 214,7	200,6	
7373B2	DEFAULT	M	4	Accelerate	MaxClimb	T_01		1 372,5	222,3	
7373B2	DEFAULT	M	5	Climb	MaxClimb	ZERO	3 000			
7373B2	DEFAULT	M	6	Accelerate	MaxClimb	ZERO		1 493,4	250	
7373B2	DEFAULT	M	7	Climb	MaxClimb	ZERO	5 500			
7373B2	DEFAULT	M	8	Climb	MaxClimb	ZERO	7 500			
7373B2	DEFAULT	M	9	Climb	MaxClimb	ZERO	10 000			
7373B2	ICAO_A	1	1	Takeoff	MaxTakeoff	5				
7373B2	ICAO_A	1	2	Climb	MaxTakeoff	5	1 500			
7373B2	ICAO_A	1	3	Climb	MaxClimb	5	3 000			
7373B2	ICAO_A	1	4	Accelerate	MaxClimb	T_05		1 607,4	188,9	
7373B2	ICAO_A	1	5	Accelerate	MaxClimb	T_01		1 827,6	206	

ACFTID	Profile_ID	Stage Length	Step Number	Step Type	Thrust Rating	Flap_ID	End Point Altitude (ft)	Rate Of Climb (ft/min)	End Point CAS (kt)	Accelerate_Percent (%)
7373B2	ICAO_A	1	6	Accelerate	MaxClimb	ZERO		2 030,2	250	
7373B2	ICAO_A	1	7	Climb	MaxClimb	ZERO	5 500			
7373B2	ICAO_A	1	8	Climb	MaxClimb	ZERO	7 500			
7373B2	ICAO_A	1	9	Climb	MaxClimb	ZERO	10 000			
7373B2	ICAO_A	2	1	Takeoff	MaxTakeoff	5				
7373B2	ICAO_A	2	2	Climb	MaxTakeoff	5	1 500			
7373B2	ICAO_A	2	3	Climb	MaxClimb	5	3 000			
7373B2	ICAO_A	2	4	Accelerate	MaxClimb	T_05		1 507,4	188,9	
7373B2	ICAO_A	2	5	Accelerate	MaxClimb	T_01		1 703,4	206	
7373B2	ICAO_A	2	6	Accelerate	MaxClimb	ZERO		1 909,1	250	
7373B2	ICAO_A	2	7	Climb	MaxClimb	ZERO	5 500			
7373B2	ICAO_A	2	8	Climb	MaxClimb	ZERO	7 500			
7373B2	ICAO_A	2	9	Climb	MaxClimb	ZERO	10 000			
7373B2	ICAO_A	3	1	Takeoff	MaxTakeoff	5				
7373B2	ICAO_A	3	2	Climb	MaxTakeoff	5	1 500			
7373B2	ICAO_A	3	3	Climb	MaxClimb	5	3 000			
7373B2	ICAO_A	3	4	Accelerate	MaxClimb	T_05		1 417,2	191,3	
7373B2	ICAO_A	3	5	Accelerate	MaxClimb	T_01		1 604,3	213,7	
7373B2	ICAO_A	3	6	Accelerate	MaxClimb	ZERO		1 807,6	250	
7373B2	ICAO_A	3	7	Climb	MaxClimb	ZERO	5 500			

ACFTID	Profile_ID	Stage Length	Step Number	Step Type	Thrust Rating	Flap_ID	End Point Altitude (ft)	Rate Of Climb (ft/min)	End Point CAS (kt)	Accelerate_Percent (%)
7373B2	ICAO_A	3	8	Climb	MaxClimb	ZERO	7 500			
7373B2	ICAO_A	3	9	Climb	MaxClimb	ZERO	10 000			
7373B2	ICAO_A	4	1	Takeoff	MaxTakeoff	5				
7373B2	ICAO_A	4	2	Climb	MaxTakeoff	5	1 500			
7373B2	ICAO_A	4	3	Climb	MaxClimb	5	3 000			
7373B2	ICAO_A	4	4	Accelerate	MaxClimb	T_05		1 255,2	195,4	
7373B2	ICAO_A	4	5	Accelerate	MaxClimb	T_01		1 411,8	212,1	
7373B2	ICAO_A	4	6	Accelerate	MaxClimb	ZERO		1 576,8	250	
7373B2	ICAO_A	4	7	Climb	MaxClimb	ZERO	5 500			
7373B2	ICAO_A	4	8	Climb	MaxClimb	ZERO	7 500			
7373B2	ICAO_A	4	9	Climb	MaxClimb	ZERO	10 000			
7373B2	ICAO_A	M	1	Takeoff	MaxTakeoff	5				
7373B2	ICAO_A	M	2	Climb	MaxTakeoff	5	1 500			
7373B2	ICAO_A	M	3	Climb	MaxClimb	5	3 000			
7373B2	ICAO_A	M	4	Accelerate	MaxClimb	T_05		1 163,2	198,2	
7373B2	ICAO_A	M	5	Accelerate	MaxClimb	T_01		1 309,7	220,9	
7373B2	ICAO_A	M	6	Accelerate	MaxClimb	ZERO		1 469,1	250	
7373B2	ICAO_A	M	7	Climb	MaxClimb	ZERO	5 500			
7373B2	ICAO_A	M	8	Climb	MaxClimb	ZERO	7 500			
7373B2	ICAO_A	M	9	Climb	MaxClimb	ZERO	10 000			

ACFTID	Profile_ID	Stage Length	Step Number	Step Type	Thrust Rating	Flap_ID	End Point Altitude (ft)	Rate Of Climb (ft/min)	End Point CAS (kt)	Accelerate_Percent (%)
7373B2	ICAO_B	1	1	Takeoff	MaxTakeoff	5				
7373B2	ICAO_B	1	2	Climb	MaxTakeoff	5	1 000			
7373B2	ICAO_B	1	3	Accelerate	MaxTakeoff	T_05		1 881	195,6	
7373B2	ICAO_B	1	4	Accelerate	MaxTakeoff	T_01		2 138,5	214,5	
7373B2	ICAO_B	1	5	Climb	MaxClimb	ZERO	3 000			
7373B2	ICAO_B	1	6	Accelerate	MaxClimb	ZERO		2 075,4	250	
7373B2	ICAO_B	1	7	Climb	MaxClimb	ZERO	5 500			
7373B2	ICAO_B	1	8	Climb	MaxClimb	ZERO	7 500			
7373B2	ICAO_B	1	9	Climb	MaxClimb	ZERO	10 000			
7373B2	ICAO_B	2	1	Takeoff	MaxTakeoff	5				
7373B2	ICAO_B	2	2	Climb	MaxTakeoff	5	1 000			
7373B2	ICAO_B	2	3	Accelerate	MaxTakeoff	T_05		1 774,2	196,2	
7373B2	ICAO_B	2	4	Accelerate	MaxTakeoff	T_01		2 009,3	214	
7373B2	ICAO_B	2	5	Climb	MaxClimb	ZERO	3 000			
7373B2	ICAO_B	2	6	Accelerate	MaxClimb	ZERO		1 950,7	250	
7373B2	ICAO_B	2	7	Climb	MaxClimb	ZERO	5 500			
7373B2	ICAO_B	2	8	Climb	MaxClimb	ZERO	7 500			
7373B2	ICAO_B	2	9	Climb	MaxClimb	ZERO	10 000			
7373B2	ICAO_B	3	1	Takeoff	MaxTakeoff	5				
7373B2	ICAO_B	3	2	Climb	MaxTakeoff	5	1 000			

ACFTID	Profile_ID	Stage Length	Step Number	Step Type	Thrust Rating	Flap_ID	End Point Altitude (ft)	Rate Of Climb (ft/min)	End Point CAS (kt)	Accelerate_Percent (%)
7373B2	ICAO_B	3	3	Accelerate	MaxTakeoff	T_05		1 674,8	197,4	
7373B2	ICAO_B	3	4	Accelerate	MaxTakeoff	T_01		1 895,7	217	
7373B2	ICAO_B	3	5	Climb	MaxClimb	ZERO	3 000			
7373B2	ICAO_B	3	6	Accelerate	MaxClimb	ZERO		1 835,6	250	
7373B2	ICAO_B	3	7	Climb	MaxClimb	ZERO	5 500			
7373B2	ICAO_B	3	8	Climb	MaxClimb	ZERO	7 500			
7373B2	ICAO_B	3	9	Climb	MaxClimb	ZERO	10 000			
7373B2	ICAO_B	4	1	Takeoff	MaxTakeoff	5				
7373B2	ICAO_B	4	2	Climb	MaxTakeoff	5	1 000			
7373B2	ICAO_B	4	3	Accelerate	MaxTakeoff	T_05		1 494,5	200,9	
7373B2	ICAO_B	4	4	Accelerate	MaxTakeoff	T_01		1 672,5	215,5	
7373B2	ICAO_B	4	5	Climb	MaxClimb	ZERO	3 000			
7373B2	ICAO_B	4	6	Accelerate	MaxClimb	ZERO		1 606,9	250	
7373B2	ICAO_B	4	7	Climb	MaxClimb	ZERO	5 500			
7373B2	ICAO_B	4	8	Climb	MaxClimb	ZERO	7 500			
7373B2	ICAO_B	4	9	Climb	MaxClimb	ZERO	10 000			
7373B2	ICAO_B	M	1	Takeoff	MaxTakeoff	5				
7373B2	ICAO_B	M	2	Climb	MaxTakeoff	5	1 000			
7373B2	ICAO_B	M	3	Accelerate	MaxTakeoff	T_05		1 387,7	203,4	
7373B2	ICAO_B	M	4	Accelerate	MaxTakeoff	T_01		1 557,1	223,7	

ACFTID	Profile_ID	Stage Length	Step Number	Step Type	Thrust Rating	Flap_ID	End Point Altitude (ft)	Rate Of Climb (ft/min)	End Point CAS (kt)	Accelerate_Percent (%)
7373B2	ICAO_B	M	5	Climb	MaxClimb	ZERO	3 000			
7373B2	ICAO_B	M	6	Accelerate	MaxClimb	ZERO		1 493,2	250	
7373B2	ICAO_B	M	7	Climb	MaxClimb	ZERO	5 500			
7373B2	ICAO_B	M	8	Climb	MaxClimb	ZERO	7 500			
7373B2	ICAO_B	M	9	Climb	MaxClimb	ZERO	10 000			
737400	DEFAULT	1	1	Takeoff	MaxTakeoff	5				
737400	DEFAULT	1	2	Climb	MaxTakeoff	5	1 000			
737400	DEFAULT	1	3	Accelerate	MaxClimb	5		1 715,3	198,8	
737400	DEFAULT	1	4	Accelerate	MaxClimb	1		1 894,7	210,5	
737400	DEFAULT	1	5	Climb	MaxClimb	ZERO	3 000			
737400	DEFAULT	1	6	Accelerate	MaxClimb	ZERO		2 067,4	250	
737400	DEFAULT	1	7	Climb	MaxClimb	ZERO	5 500			
737400	DEFAULT	1	8	Climb	MaxClimb	ZERO	7 500			
737400	DEFAULT	1	9	Climb	MaxClimb	ZERO	10 000			
737400	DEFAULT	2	1	Takeoff	MaxTakeoff	5				
737400	DEFAULT	2	2	Climb	MaxTakeoff	5	1 000			
737400	DEFAULT	2	3	Accelerate	MaxClimb	5		1 616	199,8	
737400	DEFAULT	2	4	Accelerate	MaxClimb	1		1 786,6	210,5	
737400	DEFAULT	2	5	Climb	MaxClimb	ZERO	3 000			
737400	DEFAULT	2	6	Accelerate	MaxClimb	ZERO		1 939,1	250	

ACFTID	Profile_ID	Stage Length	Step Number	Step Type	Thrust Rating	Flap_ID	End Point Altitude (ft)	Rate Of Climb (ft/min)	End Point CAS (kt)	Accelerate_Percent (%)
737400	DEFAULT	2	7	Climb	MaxClimb	ZERO	5 500			
737400	DEFAULT	2	8	Climb	MaxClimb	ZERO	7 500			
737400	DEFAULT	2	9	Climb	MaxClimb	ZERO	10 000			
737400	DEFAULT	3	1	Takeoff	MaxTakeoff	5				
737400	DEFAULT	3	2	Climb	MaxTakeoff	5	1 000			
737400	DEFAULT	3	3	Accelerate	MaxClimb	5		1 516,6	201	
737400	DEFAULT	3	4	Accelerate	MaxClimb	1		1 660,9	210,5	
737400	DEFAULT	3	5	Climb	MaxClimb	ZERO	3 000			
737400	DEFAULT	3	6	Accelerate	MaxClimb	ZERO		1 807,5	250	
737400	DEFAULT	3	7	Climb	MaxClimb	ZERO	5 500			
737400	DEFAULT	3	8	Climb	MaxClimb	ZERO	7 500			
737400	DEFAULT	3	9	Climb	MaxClimb	ZERO	10 000			
737400	DEFAULT	4	1	Takeoff	MaxTakeoff	5				
737400	DEFAULT	4	2	Climb	MaxTakeoff	5	1 000			
737400	DEFAULT	4	3	Accelerate	MaxClimb	5		1 370,2	203,9	
737400	DEFAULT	4	4	Accelerate	MaxClimb	1		1 504,1	210,5	
737400	DEFAULT	4	5	Climb	MaxClimb	ZERO	3 000			
737400	DEFAULT	4	6	Accelerate	MaxClimb	ZERO		1 609,1	250	
737400	DEFAULT	4	7	Climb	MaxClimb	ZERO	5 500			
737400	DEFAULT	4	8	Climb	MaxClimb	ZERO	7 500			

ACFTID	Profile_ID	Stage Length	Step Number	Step Type	Thrust Rating	Flap_ID	End Point Altitude (ft)	Rate Of Climb (ft/min)	End Point CAS (kt)	Accelerate_Percent (%)
737400	DEFAULT	4	9	Climb	MaxClimb	ZERO	10 000			
737400	DEFAULT	M	1	Takeoff	MaxTakeoff	5				
737400	DEFAULT	M	2	Climb	MaxTakeoff	5	1 000			
737400	DEFAULT	M	3	Accelerate	MaxClimb	5		1 225,8	207,5	
737400	DEFAULT	M	4	Accelerate	MaxClimb	1		1 312,5	210,5	
737400	DEFAULT	M	5	Climb	MaxClimb	ZERO	3 000			
737400	DEFAULT	M	6	Accelerate	MaxClimb	ZERO		1 414,3	250	
737400	DEFAULT	M	7	Climb	MaxClimb	ZERO	5 500			
737400	DEFAULT	M	8	Climb	MaxClimb	ZERO	7 500			
737400	DEFAULT	M	9	Climb	MaxClimb	ZERO	10 000			
737400	ICAO_A	1	1	Takeoff	MaxTakeoff	5				
737400	ICAO_A	1	2	Climb	MaxTakeoff	5	1 500			
737400	ICAO_A	1	3	Climb	MaxClimb	5	3 000			
737400	ICAO_A	1	4	Accelerate	MaxClimb	5		1 641,7	195,7	
737400	ICAO_A	1	5	Accelerate	MaxClimb	1		1 830	210,1	
737400	ICAO_A	1	6	Accelerate	MaxClimb	ZERO		2 058,4	250	
737400	ICAO_A	1	7	Climb	MaxClimb	ZERO	5 500			
737400	ICAO_A	1	8	Climb	MaxClimb	ZERO	7 500			
737400	ICAO_A	1	9	Climb	MaxClimb	ZERO	10 000			
737400	ICAO_A	2	1	Takeoff	MaxTakeoff	5				

ACFTID	Profile_ID	Stage Length	Step Number	Step Type	Thrust Rating	Flap_ID	End Point Altitude (ft)	Rate Of Climb (ft/min)	End Point CAS (kt)	Accelerate_Percent (%)
737400	ICAO_A	2	2	Climb	MaxTakeoff	5	1 500			
737400	ICAO_A	2	3	Climb	MaxClimb	5	3 000			
737400	ICAO_A	2	4	Accelerate	MaxClimb	5		1 546	196,8	
737400	ICAO_A	2	5	Accelerate	MaxClimb	1		1 702,5	210,1	
737400	ICAO_A	2	6	Accelerate	MaxClimb	ZERO		1 919,2	250	
737400	ICAO_A	2	7	Climb	MaxClimb	ZERO	5 500			
737400	ICAO_A	2	8	Climb	MaxClimb	ZERO	7 500			
737400	ICAO_A	2	9	Climb	MaxClimb	ZERO	10 000			
737400	ICAO_A	3	1	Takeoff	MaxTakeoff	5				
737400	ICAO_A	3	2	Climb	MaxTakeoff	5	1 500			
737400	ICAO_A	3	3	Climb	MaxClimb	5	3 000			
737400	ICAO_A	3	4	Accelerate	MaxClimb	5		1 446,6	198,2	
737400	ICAO_A	3	5	Accelerate	MaxClimb	1		1 592,3	210,3	
737400	ICAO_A	3	6	Accelerate	MaxClimb	ZERO		1 789,6	250	
737400	ICAO_A	3	7	Climb	MaxClimb	ZERO	5 500			
737400	ICAO_A	3	8	Climb	MaxClimb	ZERO	7 500			
737400	ICAO_A	3	9	Climb	MaxClimb	ZERO	10 000			
737400	ICAO_A	4	1	Takeoff	MaxTakeoff	5				
737400	ICAO_A	4	2	Climb	MaxTakeoff	5	1 500			
737400	ICAO_A	4	3	Climb	MaxClimb	5	3 000			

ACFTID	Profile_ID	Stage Length	Step Number	Step Type	Thrust Rating	Flap_ID	End Point Altitude (ft)	Rate Of Climb (ft/min)	End Point CAS (kt)	Accelerate_Percent (%)
737400	ICAO_A	4	4	Accelerate	MaxClimb	5		1 303,9	201,3	
737400	ICAO_A	4	5	Accelerate	MaxClimb	1		1 426,1	210,3	
737400	ICAO_A	4	6	Accelerate	MaxClimb	ZERO		1 598,5	250	
737400	ICAO_A	4	7	Climb	MaxClimb	ZERO	5 500			
737400	ICAO_A	4	8	Climb	MaxClimb	ZERO	7 500			
737400	ICAO_A	4	9	Climb	MaxClimb	ZERO	10 000			
737400	ICAO_A	M	1	Takeoff	MaxTakeoff	5				
737400	ICAO_A	M	2	Climb	MaxTakeoff	5	1 500			
737400	ICAO_A	M	3	Climb	MaxClimb	5	3 000			
737400	ICAO_A	M	4	Accelerate	MaxClimb	5		1 159,5	205,1	
737400	ICAO_A	M	5	Accelerate	MaxClimb	1		1 249,3	210,3	
737400	ICAO_A	M	6	Accelerate	MaxClimb	ZERO		1 392,2	250	
737400	ICAO_A	M	7	Climb	MaxClimb	ZERO	5 500			
737400	ICAO_A	M	8	Climb	MaxClimb	ZERO	7 500			
737400	ICAO_A	M	9	Climb	MaxClimb	ZERO	10 000			
737400	ICAO_B	1	1	Takeoff	MaxTakeoff	5				
737400	ICAO_B	1	2	Climb	MaxTakeoff	5	1 000			
737400	ICAO_B	1	3	Accelerate	MaxTakeoff	5		1 869,9	201,5	
737400	ICAO_B	1	4	Accelerate	MaxTakeoff	1		2 073,3	210,5	
737400	ICAO_B	1	5	Climb	MaxClimb	ZERO	3 000			

ACFTID	Profile_ID	Stage Length	Step Number	Step Type	Thrust Rating	Flap_ID	End Point Altitude (ft)	Rate Of Climb (ft/min)	End Point CAS (kt)	Accelerate_Percent (%)
737400	ICAO_B	1	6	Accelerate	MaxClimb	ZERO		2 067,4	250	
737400	ICAO_B	1	7	Climb	MaxClimb	ZERO	5 500			
737400	ICAO_B	1	8	Climb	MaxClimb	ZERO	7 500			
737400	ICAO_B	1	9	Climb	MaxClimb	ZERO	10 000			
737400	ICAO_B	2	1	Takeoff	MaxTakeoff	5				
737400	ICAO_B	2	2	Climb	MaxTakeoff	5	1 000			
737400	ICAO_B	2	3	Accelerate	MaxTakeoff	5		1 766,9	202,3	
737400	ICAO_B	2	4	Accelerate	MaxTakeoff	1		1 945,9	210,5	
737400	ICAO_B	2	5	Climb	MaxClimb	ZERO	3 000			
737400	ICAO_B	2	6	Accelerate	MaxClimb	ZERO		1 939,1	250	
737400	ICAO_B	2	7	Climb	MaxClimb	ZERO	5 500			
737400	ICAO_B	2	8	Climb	MaxClimb	ZERO	7 500			
737400	ICAO_B	2	9	Climb	MaxClimb	ZERO	10 000			
737400	ICAO_B	3	1	Takeoff	MaxTakeoff	5				
737400	ICAO_B	3	2	Climb	MaxTakeoff	5	1 000			
737400	ICAO_B	3	3	Accelerate	MaxTakeoff	5		1 660,1	203,4	
737400	ICAO_B	3	4	Accelerate	MaxTakeoff	1		1 822,5	210,5	
737400	ICAO_B	3	5	Climb	MaxClimb	ZERO	3 000			
737400	ICAO_B	3	6	Accelerate	MaxClimb	ZERO		1 807,5	250	
737400	ICAO_B	3	7	Climb	MaxClimb	ZERO	5 500			

ACFTID	Profile_ID	Stage Length	Step Number	Step Type	Thrust Rating	Flap_ID	End Point Altitude (ft)	Rate Of Climb (ft/min)	End Point CAS (kt)	Accelerate_Percent (%)
737400	ICAO_B	3	8	Climb	MaxClimb	ZERO	7 500			
737400	ICAO_B	3	9	Climb	MaxClimb	ZERO	10 000			
737400	ICAO_B	4	1	Takeoff	MaxTakeoff	5				
737400	ICAO_B	4	2	Climb	MaxTakeoff	5	1 000			
737400	ICAO_B	4	3	Accelerate	MaxTakeoff	5		1 502,8	206,1	
737400	ICAO_B	4	4	Accelerate	MaxTakeoff	1		1 644,7	210,5	
737400	ICAO_B	4	5	Climb	MaxClimb	ZERO	3 000			
737400	ICAO_B	4	6	Accelerate	MaxClimb	ZERO		1 610,5	250	
737400	ICAO_B	4	7	Climb	MaxClimb	ZERO	5 500			
737400	ICAO_B	4	8	Climb	MaxClimb	ZERO	7 500			
737400	ICAO_B	4	9	Climb	MaxClimb	ZERO	10 000			
737400	ICAO_B	M	1	Takeoff	MaxTakeoff	5				
737400	ICAO_B	M	2	Climb	MaxTakeoff	5	1 000			
737400	ICAO_B	M	3	Accelerate	MaxTakeoff	5		1 350,9	209,5	
737400	ICAO_B	M	4	Accelerate	MaxTakeoff	1		1 428,6	210,5	
737400	ICAO_B	M	5	Climb	MaxClimb	ZERO	3 000			
737400	ICAO_B	M	6	Accelerate	MaxClimb	ZERO		1 414,7	250	
737400	ICAO_B	M	7	Climb	MaxClimb	ZERO	5 500			
737400	ICAO_B	M	8	Climb	MaxClimb	ZERO	7 500			
737400	ICAO_B	M	9	Climb	MaxClimb	ZERO	10 000			

ACFTID	Profile_ID	Stage Length	Step Number	Step Type	Thrust Rating	Flap_ID	End Point Altitude (ft)	Rate Of Climb (ft/min)	End Point CAS (kt)	Accelerate_Percent (%)
737500	DEFAULT	1	1	Takeoff	MaxTakeoff	5				
737500	DEFAULT	1	2	Climb	MaxTakeoff	5	1 000			
737500	DEFAULT	1	3	Accelerate	MaxClimb	5		1 579,1	187	
737500	DEFAULT	1	4	Accelerate	MaxClimb	1		1 800	206,6	
737500	DEFAULT	1	5	Climb	MaxClimb	ZERO	3 000			
737500	DEFAULT	1	6	Accelerate	MaxClimb	ZERO		1 961,7	250	
737500	DEFAULT	1	7	Climb	MaxClimb	ZERO	5 500			
737500	DEFAULT	1	8	Climb	MaxClimb	ZERO	7 500			
737500	DEFAULT	1	9	Climb	MaxClimb	ZERO	10 000			
737500	DEFAULT	2	1	Takeoff	MaxTakeoff	5				
737500	DEFAULT	2	2	Climb	MaxTakeoff	5	1 000			
737500	DEFAULT	2	3	Accelerate	MaxClimb	5		1 490,8	188	
737500	DEFAULT	2	4	Accelerate	MaxClimb	1		1 681,3	205,6	
737500	DEFAULT	2	5	Climb	MaxClimb	ZERO	3 000			
737500	DEFAULT	2	6	Accelerate	MaxClimb	ZERO		1 834,4	250	
737500	DEFAULT	2	7	Climb	MaxClimb	ZERO	5 500			
737500	DEFAULT	2	8	Climb	MaxClimb	ZERO	7 500			
737500	DEFAULT	2	9	Climb	MaxClimb	ZERO	10 000			
737500	DEFAULT	3	1	Takeoff	MaxTakeoff	5				
737500	DEFAULT	3	2	Climb	MaxTakeoff	5	1 000			

ACFTID	Profile_ID	Stage Length	Step Number	Step Type	Thrust Rating	Flap_ID	End Point Altitude (ft)	Rate Of Climb (ft/min)	End Point CAS (kt)	Accelerate_Percent (%)
737500	DEFAULT	3	3	Accelerate	MaxClimb	5		1 398,8	189,4	
737500	DEFAULT	3	4	Accelerate	MaxClimb	1		1 572,4	204,5	
737500	DEFAULT	3	5	Climb	MaxClimb	ZERO	3 000			
737500	DEFAULT	3	6	Accelerate	MaxClimb	ZERO		1 713,4	250	
737500	DEFAULT	3	7	Climb	MaxClimb	ZERO	5 500			
737500	DEFAULT	3	8	Climb	MaxClimb	ZERO	7 500			
737500	DEFAULT	3	9	Climb	MaxClimb	ZERO	10 000			
737500	DEFAULT	4	1	Takeoff	MaxTakeoff	5				
737500	DEFAULT	4	2	Climb	MaxTakeoff	5	1 000			
737500	DEFAULT	4	3	Accelerate	MaxClimb	5		1 229,4	192,1	
737500	DEFAULT	4	4	Accelerate	MaxClimb	1		1 388,1	212,4	
737500	DEFAULT	4	5	Climb	MaxClimb	ZERO	3 000			
737500	DEFAULT	4	6	Accelerate	MaxClimb	ZERO		1 521,8	250	
737500	DEFAULT	4	7	Climb	MaxClimb	ZERO	5 500			
737500	DEFAULT	4	8	Climb	MaxClimb	ZERO	7 500			
737500	DEFAULT	4	9	Climb	MaxClimb	ZERO	10 000			
737500	DEFAULT	5	1	Takeoff	MaxTakeoff	5				
737500	DEFAULT	5	2	Climb	MaxTakeoff	5	1 000			
737500	DEFAULT	5	3	Accelerate	MaxClimb	5		1 211,1	192,4	
737500	DEFAULT	5	4	Accelerate	MaxClimb	1		1 370,8	212	

ACFTID	Profile_ID	Stage Length	Step Number	Step Type	Thrust Rating	Flap_ID	End Point Altitude (ft)	Rate Of Climb (ft/min)	End Point CAS (kt)	Accelerate_Percent (%)
737500	DEFAULT	5	5	Climb	MaxClimb	ZERO	3 000			
737500	DEFAULT	5	6	Accelerate	MaxClimb	ZERO		1 503,1	250	
737500	DEFAULT	5	7	Climb	MaxClimb	ZERO	5 500			
737500	DEFAULT	5	8	Climb	MaxClimb	ZERO	7 500			
737500	DEFAULT	5	9	Climb	MaxClimb	ZERO	10 000			
737500	DEFAULT	M	1	Takeoff	MaxTakeoff	5				
737500	DEFAULT	M	2	Climb	MaxTakeoff	5	1 000			
737500	DEFAULT	M	3	Accelerate	MaxClimb	5		1 192,6	192,8	
737500	DEFAULT	M	4	Accelerate	MaxClimb	1		1 343,1	211,9	
737500	DEFAULT	M	5	Climb	MaxClimb	ZERO	3 000			
737500	DEFAULT	M	6	Accelerate	MaxClimb	ZERO		1 470,2	250	
737500	DEFAULT	M	7	Climb	MaxClimb	ZERO	5 500			
737500	DEFAULT	M	8	Climb	MaxClimb	ZERO	7 500			
737500	DEFAULT	M	9	Climb	MaxClimb	ZERO	10 000			
737500	ICAO_A	1	1	Takeoff	MaxTakeoff	5				
737500	ICAO_A	1	2	Climb	MaxTakeoff	5	1 500			
737500	ICAO_A	1	3	Climb	MaxClimb	5	3 000			
737500	ICAO_A	1	4	Accelerate	MaxClimb	5		1 509,2	184	
737500	ICAO_A	1	5	Accelerate	MaxClimb	1		1 725,7	204,8	
737500	ICAO_A	1	6	Accelerate	MaxClimb	ZERO		1 934,3	250	

ACFTID	Profile_ID	Stage Length	Step Number	Step Type	Thrust Rating	Flap_ID	End Point Altitude (ft)	Rate Of Climb (ft/min)	End Point CAS (kt)	Accelerate_Percent (%)
737500	ICAO_A	1	7	Climb	MaxClimb	ZERO	5 500			
737500	ICAO_A	1	8	Climb	MaxClimb	ZERO	7 500			
737500	ICAO_A	1	9	Climb	MaxClimb	ZERO	10 000			
737500	ICAO_A	2	1	Takeoff	MaxTakeoff	5				
737500	ICAO_A	2	2	Climb	MaxTakeoff	5	1 500			
737500	ICAO_A	2	3	Climb	MaxClimb	5	3 000			
737500	ICAO_A	2	4	Accelerate	MaxClimb	5	1 420,9		185,1	
737500	ICAO_A	2	5	Accelerate	MaxClimb	1	1 612,5		203,9	
737500	ICAO_A	2	6	Accelerate	MaxClimb	ZERO	1 810,3		250	
737500	ICAO_A	2	7	Climb	MaxClimb	ZERO	5 500			
737500	ICAO_A	2	8	Climb	MaxClimb	ZERO	7 500			
737500	ICAO_A	2	9	Climb	MaxClimb	ZERO	10 000			
737500	ICAO_A	3	1	Takeoff	MaxTakeoff	5				
737500	ICAO_A	3	2	Climb	MaxTakeoff	5	1 500			
737500	ICAO_A	3	3	Climb	MaxClimb	5	3 000			
737500	ICAO_A	3	4	Accelerate	MaxClimb	5	1 332,5		186,6	
737500	ICAO_A	3	5	Accelerate	MaxClimb	1	1 494,3		203	
737500	ICAO_A	3	6	Accelerate	MaxClimb	ZERO	1 691,3		250	
737500	ICAO_A	3	7	Climb	MaxClimb	ZERO	5 500			
737500	ICAO_A	3	8	Climb	MaxClimb	ZERO	7 500			

ACFTID	Profile_ID	Stage Length	Step Number	Step Type	Thrust Rating	Flap_ID	End Point Altitude (ft)	Rate Of Climb (ft/min)	End Point CAS (kt)	Accelerate_Percent (%)
737500	ICAO_A	3	9	Climb	MaxClimb	ZERO	10 000			
737500	ICAO_A	4	1	Takeoff	MaxTakeoff	5				
737500	ICAO_A	4	2	Climb	MaxTakeoff	5	1 500			
737500	ICAO_A	4	3	Climb	MaxClimb	5	3 000			
737500	ICAO_A	4	4	Accelerate	MaxClimb	5		1 166,9	189,6	
737500	ICAO_A	4	5	Accelerate	MaxClimb	1		1 317	211	
737500	ICAO_A	4	6	Accelerate	MaxClimb	ZERO		1 496,1	250	
737500	ICAO_A	4	7	Climb	MaxClimb	ZERO	5 500			
737500	ICAO_A	4	8	Climb	MaxClimb	ZERO	7 500			
737500	ICAO_A	4	9	Climb	MaxClimb	ZERO	10 000			
737500	ICAO_A	5	1	Takeoff	MaxTakeoff	5				
737500	ICAO_A	5	2	Climb	MaxTakeoff	5	1 500			
737500	ICAO_A	5	3	Climb	MaxClimb	5	3 000			
737500	ICAO_A	5	4	Accelerate	MaxClimb	5		1 152,1	189,9	
737500	ICAO_A	5	5	Accelerate	MaxClimb	1		1 300	210,8	
737500	ICAO_A	5	6	Accelerate	MaxClimb	ZERO		1 477,5	250	
737500	ICAO_A	5	7	Climb	MaxClimb	ZERO	5 500			
737500	ICAO_A	5	8	Climb	MaxClimb	ZERO	7 500			
737500	ICAO_A	5	9	Climb	MaxClimb	ZERO	10 000			
737500	ICAO_A	M	1	Takeoff	MaxTakeoff	5				

ACFTID	Profile_ID	Stage Length	Step Number	Step Type	Thrust Rating	Flap_ID	End Point Altitude (ft)	Rate Of Climb (ft/min)	End Point CAS (kt)	Accelerate_Percent (%)
737500	ICAO_A	M	2	Climb	MaxTakeoff	5	1 500			
737500	ICAO_A	M	3	Climb	MaxClimb	5	3 000			
737500	ICAO_A	M	4	Accelerate	MaxClimb	5		1 130,1	190,4	
737500	ICAO_A	M	5	Accelerate	MaxClimb	1		1 267,1	210,6	
737500	ICAO_A	M	6	Accelerate	MaxClimb	ZERO		1 451,9	250	
737500	ICAO_A	M	7	Climb	MaxClimb	ZERO	5 500			
737500	ICAO_A	M	8	Climb	MaxClimb	ZERO	7 500			
737500	ICAO_A	M	9	Climb	MaxClimb	ZERO	10 000			
737500	ICAO_B	1	1	Takeoff	MaxTakeoff	5				
737500	ICAO_B	1	2	Climb	MaxTakeoff	5	1 000			
737500	ICAO_B	1	3	Accelerate	MaxTakeoff	5		1 715,3	189,5	
737500	ICAO_B	1	4	Accelerate	MaxTakeoff	1		1 944,8	207,8	
737500	ICAO_B	1	5	Climb	MaxClimb	ZERO	3 000			
737500	ICAO_B	1	6	Accelerate	MaxClimb	ZERO		1 966,3	250	
737500	ICAO_B	1	7	Climb	MaxClimb	ZERO	5 500			
737500	ICAO_B	1	8	Climb	MaxClimb	ZERO	7 500			
737500	ICAO_B	1	9	Climb	MaxClimb	ZERO	10 000			
737500	ICAO_B	2	1	Takeoff	MaxTakeoff	5				
737500	ICAO_B	2	2	Climb	MaxTakeoff	5	1 000			
737500	ICAO_B	2	3	Accelerate	MaxTakeoff	5		1 619,6	190,3	

ACFTID	Profile_ID	Stage Length	Step Number	Step Type	Thrust Rating	Flap_ID	End Point Altitude (ft)	Rate Of Climb (ft/min)	End Point CAS (kt)	Accelerate_Percent (%)
737500	ICAO_B	2	4	Accelerate	MaxTakeoff	1		1 835,3	207,1	
737500	ICAO_B	2	5	Climb	MaxClimb	ZERO	3 000			
737500	ICAO_B	2	6	Accelerate	MaxClimb	ZERO		1 844,6	250	
737500	ICAO_B	2	7	Climb	MaxClimb	ZERO	5 500			
737500	ICAO_B	2	8	Climb	MaxClimb	ZERO	7 500			
737500	ICAO_B	2	9	Climb	MaxClimb	ZERO	10 000			
737500	ICAO_B	3	1	Takeoff	MaxTakeoff	5				
737500	ICAO_B	3	2	Climb	MaxTakeoff	5	1 000			
737500	ICAO_B	3	3	Accelerate	MaxTakeoff	5		1 520,2	191,6	
737500	ICAO_B	3	4	Accelerate	MaxTakeoff	1		1 717,5	207,1	
737500	ICAO_B	3	5	Climb	MaxClimb	ZERO	3 000			
737500	ICAO_B	3	6	Accelerate	MaxClimb	ZERO		1 722,6	250	
737500	ICAO_B	3	7	Climb	MaxClimb	ZERO	5 500			
737500	ICAO_B	3	8	Climb	MaxClimb	ZERO	7 500			
737500	ICAO_B	3	9	Climb	MaxClimb	ZERO	10 000			
737500	ICAO_B	4	1	Takeoff	MaxTakeoff	5				
737500	ICAO_B	4	2	Climb	MaxTakeoff	5	1 000			
737500	ICAO_B	4	3	Accelerate	MaxTakeoff	5		1 339,9	194,1	
737500	ICAO_B	4	4	Accelerate	MaxTakeoff	1		1 512,8	213,4	
737500	ICAO_B	4	5	Climb	MaxClimb	ZERO	3 000			

ACFTID	Profile_ID	Stage Length	Step Number	Step Type	Thrust Rating	Flap_ID	End Point Altitude (ft)	Rate Of Climb (ft/min)	End Point CAS (kt)	Accelerate_Percent (%)
737500	ICAO_B	4	6	Accelerate	MaxClimb	ZERO		1 526,7	250	
737500	ICAO_B	4	7	Climb	MaxClimb	ZERO	5 500			
737500	ICAO_B	4	8	Climb	MaxClimb	ZERO	7 500			
737500	ICAO_B	4	9	Climb	MaxClimb	ZERO	10 000			
737500	ICAO_B	5	1	Takeoff	MaxTakeoff	5				
737500	ICAO_B	5	2	Climb	MaxTakeoff	5	1 000			
737500	ICAO_B	5	3	Accelerate	MaxTakeoff	5		1 322,2	194,4	
737500	ICAO_B	5	4	Accelerate	MaxTakeoff	1		1 500	213,2	
737500	ICAO_B	5	5	Climb	MaxClimb	ZERO	3 000			
737500	ICAO_B	5	6	Accelerate	MaxClimb	ZERO		1 503,1	250	
737500	ICAO_B	5	7	Climb	MaxClimb	ZERO	5 500			
737500	ICAO_B	5	8	Climb	MaxClimb	ZERO	7 500			
737500	ICAO_B	5	9	Climb	MaxClimb	ZERO	10 000			
737500	ICAO_B	M	1	Takeoff	MaxTakeoff	5				
737500	ICAO_B	M	2	Climb	MaxTakeoff	5	1 000			
737500	ICAO_B	M	3	Accelerate	MaxTakeoff	5		1 303,1	194,8	
737500	ICAO_B	M	4	Accelerate	MaxTakeoff	1		1 463,2	213	
737500	ICAO_B	M	5	Climb	MaxClimb	ZERO	3 000			
737500	ICAO_B	M	6	Accelerate	MaxClimb	ZERO		1 475,5	250	
737500	ICAO_B	M	7	Climb	MaxClimb	ZERO	5 500			

ACFTID	Profile_ID	Stage Length	Step Number	Step Type	Thrust Rating	Flap_ID	End Point Altitude (ft)	Rate Of Climb (ft/min)	End Point CAS (kt)	Accelerate_Percent (%)
737500	ICAO_B	M	8	Climb	MaxClimb	ZERO	7 500			
737500	ICAO_B	M	9	Climb	MaxClimb	ZERO	10 000			
737700	DEFAULT	1	1	Takeoff	MaxTakeoff	T_5				
737700	DEFAULT	1	2	Climb	MaxTakeoff	T_5	1 000			
737700	DEFAULT	1	3	Accelerate	MaxClimb	T_ZERO		1 782,4	195,1	
737700	DEFAULT	1	4	Climb	MaxClimb	T_ZERO	3 000			
737700	DEFAULT	1	5	Accelerate	MaxClimb	T_ZERO		2 159,3	250	
737700	DEFAULT	1	6	Climb	MaxClimb	T_ZERO	5 500			
737700	DEFAULT	1	7	Climb	MaxClimb	T_00H	7 500			
737700	DEFAULT	1	8	Climb	MaxClimb	T_00H	10 000			
737700	DEFAULT	2	1	Takeoff	MaxTakeoff	T_5				
737700	DEFAULT	2	2	Climb	MaxTakeoff	T_5	1 000			
737700	DEFAULT	2	3	Accelerate	MaxClimb	T_ZERO		1 710,1	197,7	
737700	DEFAULT	2	4	Climb	MaxClimb	T_ZERO	3 000			
737700	DEFAULT	2	5	Accelerate	MaxClimb	T_ZERO		2 056,7	250	
737700	DEFAULT	2	6	Climb	MaxClimb	T_ZERO	5 500			
737700	DEFAULT	2	7	Climb	MaxClimb	T_00H	7 500			
737700	DEFAULT	2	8	Climb	MaxClimb	T_00H	10 000			
737700	DEFAULT	3	1	Takeoff	MaxTakeoff	T_5				
737700	DEFAULT	3	2	Climb	MaxTakeoff	T_5	1 000			

ACFTID	Profile_ID	Stage Length	Step Number	Step Type	Thrust Rating	Flap_ID	End Point Altitude (ft)	Rate Of Climb (ft/min)	End Point CAS (kt)	Accelerate_Percent (%)
737700	DEFAULT	3	3	Accelerate	MaxClimb	T_ZERO		1 635,7	200,3	
737700	DEFAULT	3	4	Climb	MaxClimb	T_ZERO	3 000			
737700	DEFAULT	3	5	Accelerate	MaxClimb	T_ZERO		1 957	250	
737700	DEFAULT	3	6	Climb	MaxClimb	T_ZERO	5 500			
737700	DEFAULT	3	7	Climb	MaxClimb	T_ZERO	7 500			
737700	DEFAULT	3	8	Climb	MaxClimb	T_00H	10 000			
737700	DEFAULT	4	1	Takeoff	MaxTakeoff	T_5				
737700	DEFAULT	4	2	Climb	MaxTakeoff	T_5	1 000			
737700	DEFAULT	4	3	Accelerate	MaxClimb	T_ZERO		1 498,3	205,8	
737700	DEFAULT	4	4	Climb	MaxClimb	T_ZERO	3 000			
737700	DEFAULT	4	5	Accelerate	MaxClimb	T_ZERO		1 774,4	250	
737700	DEFAULT	4	6	Climb	MaxClimb	T_ZERO	5 500			
737700	DEFAULT	4	7	Climb	MaxClimb	T_ZERO	7 500			
737700	DEFAULT	4	8	Climb	MaxClimb	T_ZERO	10 000			
737700	DEFAULT	5	1	Takeoff	MaxTakeoff	T_5				
737700	DEFAULT	5	2	Climb	MaxTakeoff	T_5	1 000			
737700	DEFAULT	5	3	Accelerate	MaxClimb	T_ZERO		1 348,5	211,6	
737700	DEFAULT	5	4	Climb	MaxClimb	T_ZERO	3 000			
737700	DEFAULT	5	5	Accelerate	MaxClimb	T_ZERO		1 581,2	250	
737700	DEFAULT	5	6	Climb	MaxClimb	T_ZERO	5 500			

ACFTID	Profile_ID	Stage Length	Step Number	Step Type	Thrust Rating	Flap_ID	End Point Altitude (ft)	Rate Of Climb (ft/min)	End Point CAS (kt)	Accelerate_Percent (%)
737700	DEFAULT	5	7	Climb	MaxClimb	T_ZERO	7 500			
737700	DEFAULT	5	8	Climb	MaxClimb	T_ZERO	10 000			
737700	DEFAULT	6	1	Takeoff	MaxTakeoff	T_5				
737700	DEFAULT	6	2	Climb	MaxTakeoff	T_5	1 000			
737700	DEFAULT	6	3	Accelerate	MaxClimb	T_ZERO		1 347,1	211,6	
737700	DEFAULT	6	4	Climb	MaxClimb	T_ZERO	3 000			
737700	DEFAULT	6	5	Accelerate	MaxClimb	T_ZERO		1 579,1	250	
737700	DEFAULT	6	6	Climb	MaxClimb	T_ZERO	5 500			
737700	DEFAULT	6	7	Climb	MaxClimb	T_ZERO	7 500			
737700	DEFAULT	6	8	Climb	MaxClimb	T_ZERO	10 000			
737700	ICAO_A	1	1	Takeoff	MaxTakeoff	T_5				
737700	ICAO_A	1	2	Climb	MaxTakeoff	T_5	1 500			
737700	ICAO_A	1	3	Climb	MaxClimb	T_5	3 000			
737700	ICAO_A	1	4	Accelerate	MaxClimb	T_ZERO		1 747,6	194,9	
737700	ICAO_A	1	5	Accelerate	MaxClimb	T_ZERO		2 128,3	250	
737700	ICAO_A	1	6	Climb	MaxClimb	T_ZERO	5 500			
737700	ICAO_A	1	7	Climb	MaxClimb	T_00H	7 500			
737700	ICAO_A	1	8	Climb	MaxClimb	T_00H	10 000			
737700	ICAO_A	2	1	Takeoff	MaxTakeoff	T_5				
737700	ICAO_A	2	2	Climb	MaxTakeoff	T_5	1 500			

ACFTID	Profile_ID	Stage Length	Step Number	Step Type	Thrust Rating	Flap_ID	End Point Altitude (ft)	Rate Of Climb (ft/min)	End Point CAS (kt)	Accelerate_Percent (%)
737700	ICAO_A	2	3	Climb	MaxClimb	T_5	3 000			
737700	ICAO_A	2	4	Accelerate	MaxClimb	T_ZERO		1 673,6	197,4	
737700	ICAO_A	2	5	Accelerate	MaxClimb	T_ZERO		2 028,3	250	
737700	ICAO_A	2	6	Climb	MaxClimb	T_ZERO	5 500			
737700	ICAO_A	2	7	Climb	MaxClimb	T_ZERO	7 500			
737700	ICAO_A	2	8	Climb	MaxClimb	T_00H	10 000			
737700	ICAO_A	3	1	Takeoff	MaxTakeoff	T_5				
737700	ICAO_A	3	2	Climb	MaxTakeoff	T_5	1 500			
737700	ICAO_A	3	3	Climb	MaxClimb	T_5	3 000			
737700	ICAO_A	3	4	Accelerate	MaxClimb	T_ZERO		1 600,5	200,2	
737700	ICAO_A	3	5	Accelerate	MaxClimb	T_ZERO		1 931,7	250	
737700	ICAO_A	3	6	Climb	MaxClimb	T_ZERO	5 500			
737700	ICAO_A	3	7	Climb	MaxClimb	T_ZERO	7 500			
737700	ICAO_A	3	8	Climb	MaxClimb	T_00H	10 000			
737700	ICAO_A	4	1	Takeoff	MaxTakeoff	T_5				
737700	ICAO_A	4	2	Climb	MaxTakeoff	T_5	1 500			
737700	ICAO_A	4	3	Climb	MaxClimb	T_5	3 000			
737700	ICAO_A	4	4	Accelerate	MaxClimb	T_ZERO		1 462,2	205,6	
737700	ICAO_A	4	5	Accelerate	MaxClimb	T_ZERO		1 753,8	250	
737700	ICAO_A	4	6	Climb	MaxClimb	T_ZERO	5 500			

ACFTID	Profile_ID	Stage Length	Step Number	Step Type	Thrust Rating	Flap_ID	End Point Altitude (ft)	Rate Of Climb (ft/min)	End Point CAS (kt)	Accelerate_Percent (%)
737700	ICAO_A	4	7	Climb	MaxClimb	T_ZERO	7 500			
737700	ICAO_A	4	8	Climb	MaxClimb	T_00H	10 000			
737700	ICAO_A	5	1	Takeoff	MaxTakeoff	T_5				
737700	ICAO_A	5	2	Climb	MaxTakeoff	T_5	1 500			
737700	ICAO_A	5	3	Climb	MaxClimb	T_5	3 000			
737700	ICAO_A	5	4	Accelerate	MaxClimb	T_ZERO		1 430	250	
737700	ICAO_A	5	5	Climb	MaxClimb	T_ZERO	5 500			
737700	ICAO_A	5	6	Climb	MaxClimb	T_ZERO	7 500			
737700	ICAO_A	5	7	Climb	MaxClimb	T_ZERO	10 000			
737700	ICAO_A	6	1	Takeoff	MaxTakeoff	T_5				
737700	ICAO_A	6	2	Climb	MaxTakeoff	T_5	1 500			
737700	ICAO_A	6	3	Climb	MaxClimb	T_5	3 000			
737700	ICAO_A	6	4	Accelerate	MaxClimb	T_ZERO		1 430,1	250	
737700	ICAO_A	6	5	Climb	MaxClimb	T_ZERO	5 500			
737700	ICAO_A	6	6	Climb	MaxClimb	T_ZERO	7 500			
737700	ICAO_A	6	7	Climb	MaxClimb	T_ZERO	10 000			
737700	ICAO_B	1	1	Takeoff	MaxTakeoff	T_5				
737700	ICAO_B	1	2	Climb	MaxTakeoff	T_5	1 000			
737700	ICAO_B	1	3	Accelerate	MaxTakeoff	T_01		1 888,7	195,1	
737700	ICAO_B	1	4	Climb	MaxClimb	T_ZERO	3 000			

ACFTID	Profile_ID	Stage Length	Step Number	Step Type	Thrust Rating	Flap_ID	End Point Altitude (ft)	Rate Of Climb (ft/min)	End Point CAS (kt)	Accelerate_Percent (%)
737700	ICAO_B	1	5	Accelerate	MaxClimb	T_ZERO		2 159,3	250	
737700	ICAO_B	1	6	Climb	MaxClimb	T_00H	5 500			
737700	ICAO_B	1	7	Climb	MaxClimb	T_00H	7 500			
737700	ICAO_B	1	8	Climb	MaxClimb	T_ZERO	10 000			
737700	ICAO_B	2	1	Takeoff	MaxTakeoff	T_5				
737700	ICAO_B	2	2	Climb	MaxTakeoff	T_5	1 000			
737700	ICAO_B	2	3	Accelerate	MaxTakeoff	T_01		1 814,3	197,7	
737700	ICAO_B	2	4	Climb	MaxClimb	T_ZERO	3 000			
737700	ICAO_B	2	5	Accelerate	MaxClimb	T_ZERO		2 058,1	250	
737700	ICAO_B	2	6	Climb	MaxClimb	T_ZERO	5 500			
737700	ICAO_B	2	7	Climb	MaxClimb	T_ZERO	7 500			
737700	ICAO_B	2	8	Climb	MaxClimb	T_00H	10 000			
737700	ICAO_B	3	1	Takeoff	MaxTakeoff	T_5				
737700	ICAO_B	3	2	Climb	MaxTakeoff	T_5	1 000			
737700	ICAO_B	3	3	Accelerate	MaxTakeoff	T_5		1 619	175,6	
737700	ICAO_B	3	4	Accelerate	MaxTakeoff	T_01		1 840,6	200,4	
737700	ICAO_B	3	5	Climb	MaxClimb	T_ZERO	3 000			
737700	ICAO_B	3	6	Accelerate	MaxClimb	T_ZERO		1 958,4	250	
737700	ICAO_B	3	7	Climb	MaxClimb	T_ZERO	5 500			
737700	ICAO_B	3	8	Climb	MaxClimb	T_ZERO	7 500			

ACFTID	Profile_ID	Stage Length	Step Number	Step Type	Thrust Rating	Flap_ID	End Point Altitude (ft)	Rate Of Climb (ft/min)	End Point CAS (kt)	Accelerate_Percent (%)
737700	ICAO_B	3	9	Climb	MaxClimb	T_ZERO	10 000			
737700	ICAO_B	4	1	Takeoff	MaxTakeoff	T_5				
737700	ICAO_B	4	2	Climb	MaxTakeoff	T_5	1 000			
737700	ICAO_B	4	3	Accelerate	MaxTakeoff	T_01		1 594,1	205,8	
737700	ICAO_B	4	4	Climb	MaxClimb	T_ZERO	3 000			
737700	ICAO_B	4	5	Accelerate	MaxClimb	T_ZERO		1 774,4	250	
737700	ICAO_B	4	6	Climb	MaxClimb	T_ZERO	5 500			
737700	ICAO_B	4	7	Climb	MaxClimb	T_ZERO	7 500			
737700	ICAO_B	4	8	Climb	MaxClimb	T_ZERO	10 000			
737700	ICAO_B	5	1	Takeoff	MaxTakeoff	T_5				
737700	ICAO_B	5	2	Climb	MaxTakeoff	T_5	1 000			
737700	ICAO_B	5	3	Accelerate	MaxTakeoff	T_01		1 438,9	211,5	
737700	ICAO_B	5	4	Climb	MaxClimb	T_ZERO	3 000			
737700	ICAO_B	5	5	Accelerate	MaxClimb	T_ZERO		1 579,6	250	
737700	ICAO_B	5	6	Climb	MaxClimb	T_ZERO	5 500			
737700	ICAO_B	5	7	Climb	MaxClimb	T_ZERO	7 500			
737700	ICAO_B	5	8	Climb	MaxClimb	T_ZERO	10 000			
737700	ICAO_B	6	1	Takeoff	MaxTakeoff	T_5				
737700	ICAO_B	6	2	Climb	MaxTakeoff	T_5	1 000			
737700	ICAO_B	6	3	Accelerate	MaxTakeoff	T_01		1 437,2	211,5	

ACFTID	Profile_ID	Stage Length	Step Number	Step Type	Thrust Rating	Flap_ID	End Point Altitude (ft)	Rate Of Climb (ft/min)	End Point CAS (kt)	Accelerate_Percent (%)
737700	ICAO_B	6	4	Climb	MaxClimb	T_ZERO	3 000			
737700	ICAO_B	6	5	Accelerate	MaxClimb	T_ZERO		1 579,1	250	
737700	ICAO_B	6	6	Climb	MaxClimb	T_ZERO	5 500			
737700	ICAO_B	6	7	Climb	MaxClimb	T_ZERO	7 500			
737700	ICAO_B	6	8	Climb	MaxClimb	T_ZERO	10 000			
737800	DEFAULT	1	1	Takeoff	MaxTakeoff	T_05				
737800	DEFAULT	1	2	Climb	MaxTakeoff	T_05	1 000			
737800	DEFAULT	1	3	Accelerate	MaxTakeoff	T_05		1 885,7	181,7	
737800	DEFAULT	1	4	Accelerate	MaxTakeoff	T_01		2 112	204,8	
737800	DEFAULT	1	5	Climb	MaxTakeoff	T_00	2 040			
737800	DEFAULT	1	6	Climb	MaxClimb	T_00	3 000			
737800	DEFAULT	1	7	Accelerate	MaxClimb	T_00		1 891,3	250	
737800	DEFAULT	1	8	Climb	MaxClimb	T_00	5 500			
737800	DEFAULT	1	9	Climb	MaxClimb	T_00	7 500			
737800	DEFAULT	1	10	Climb	MaxClimb	T_00	10 000			
737800	DEFAULT	2	1	Takeoff	MaxTakeoff	T_05				
737800	DEFAULT	2	2	Climb	MaxTakeoff	T_05	1 000			
737800	DEFAULT	2	3	Accelerate	MaxTakeoff	T_05		1 786,4	183,9	
737800	DEFAULT	2	4	Accelerate	MaxTakeoff	T_01		2 016,2	208	
737800	DEFAULT	2	5	Climb	MaxTakeoff	T_00	2 000			

ACFTID	Profile_ID	Stage Length	Step Number	Step Type	Thrust Rating	Flap_ID	End Point Altitude (ft)	Rate Of Climb (ft/min)	End Point CAS (kt)	Accelerate_Percent (%)
737800	DEFAULT	2	6	Climb	MaxClimb	T_00	3 000			
737800	DEFAULT	2	7	Accelerate	MaxClimb	T_00		1 793,4	250	
737800	DEFAULT	2	8	Climb	MaxClimb	T_00	5 500			
737800	DEFAULT	2	9	Climb	MaxClimb	T_00	7 500			
737800	DEFAULT	2	10	Climb	MaxClimb	T_00	10 000			
737800	DEFAULT	3	1	Takeoff	MaxTakeoff	T_05				
737800	DEFAULT	3	2	Climb	MaxTakeoff	T_05	1 000			
737800	DEFAULT	3	3	Accelerate	MaxTakeoff	T_05		1 707,7	186,2	
737800	DEFAULT	3	4	Accelerate	MaxTakeoff	T_05		1 922	211,2	
737800	DEFAULT	3	5	Climb	MaxTakeoff	T_00	1 960			
737800	DEFAULT	3	6	Climb	MaxClimb	T_00	3 000			
737800	DEFAULT	3	7	Accelerate	MaxClimb	T_00		1 705,3	250	
737800	DEFAULT	3	8	Climb	MaxClimb	T_00	5 500			
737800	DEFAULT	3	9	Climb	MaxClimb	T_00	7 500			
737800	DEFAULT	3	10	Climb	MaxClimb	T_00	10 000			
737800	DEFAULT	4	1	Takeoff	MaxTakeoff	T_05				
737800	DEFAULT	4	2	Climb	MaxTakeoff	T_05	1 000			
737800	DEFAULT	4	3	Accelerate	MaxTakeoff	T_05		1 576,6	189,6	
737800	DEFAULT	4	4	Accelerate	MaxTakeoff	T_01		1 766,9	216,2	
737800	DEFAULT	4	5	Climb	MaxTakeoff	T_00	1 880			

ACFTID	Profile_ID	Stage Length	Step Number	Step Type	Thrust Rating	Flap_ID	End Point Altitude (ft)	Rate Of Climb (ft/min)	End Point CAS (kt)	Accelerate_Percent (%)
737800	DEFAULT	4	6	Climb	MaxClimb	T_00	3 000			
737800	DEFAULT	4	7	Accelerate	MaxClimb	T_00		1 546,5	250	
737800	DEFAULT	4	8	Climb	MaxClimb	T_00	5 500			
737800	DEFAULT	4	9	Climb	MaxClimb	T_00	7 500			
737800	DEFAULT	4	10	Climb	MaxClimb	T_00	10 000			
737800	DEFAULT	5	1	Takeoff	MaxTakeoff	T_05				
737800	DEFAULT	5	2	Climb	MaxTakeoff	T_05	1 000			
737800	DEFAULT	5	3	Accelerate	MaxTakeoff	T_05		1 444,9	192,9	
737800	DEFAULT	5	4	Accelerate	MaxTakeoff	T_01		1 628,6	220,7	
737800	DEFAULT	5	5	Climb	MaxTakeoff	T_00	1 811			
737800	DEFAULT	5	6	Climb	MaxClimb	T_00	3 000			
737800	DEFAULT	5	7	Accelerate	MaxClimb	T_00		1 412,2	250	
737800	DEFAULT	5	8	Climb	MaxClimb	T_00	5 500			
737800	DEFAULT	5	9	Climb	MaxClimb	T_00	7 500			
737800	DEFAULT	5	10	Climb	MaxClimb	T_00	10 000			
737800	DEFAULT	6	1	Takeoff	MaxTakeoff	T_05				
737800	DEFAULT	6	2	Climb	MaxTakeoff	T_05	1 000			
737800	DEFAULT	6	3	Accelerate	MaxTakeoff	T_05		1 400	194,4	
737800	DEFAULT	6	4	Accelerate	MaxTakeoff	T_01		1 575,4	222,7	
737800	DEFAULT	6	5	Climb	MaxTakeoff	T_00	1 785			

ACFTID	Profile_ID	Stage Length	Step Number	Step Type	Thrust Rating	Flap_ID	End Point Altitude (ft)	Rate Of Climb (ft/min)	End Point CAS (kt)	Accelerate_Percent (%)
737800	DEFAULT	6	6	Climb	MaxClimb	T_00	3 000			
737800	DEFAULT	6	7	Accelerate	MaxClimb	T_00		1 357,5	250	
737800	DEFAULT	6	8	Climb	MaxClimb	T_00	5 500			
737800	DEFAULT	6	9	Climb	MaxClimb	T_00	7 500			
737800	DEFAULT	6	10	Climb	MaxClimb	T_00	10 000			
737800	ICAO_A	1	1	Takeoff	MaxTakeoff	T_05				
737800	ICAO_A	1	2	Climb	MaxTakeoff	T_05	1 500			
737800	ICAO_A	1	3	Climb	MaxClimb	T_05	3 000			
737800	ICAO_A	1	4	Accelerate	MaxClimb	T_05		1 449,4	177,2	
737800	ICAO_A	1	5	Accelerate	MaxClimb	T_01		1 663,3	204,6	
737800	ICAO_A	1	6	Climb	MaxClimb	T_00	3 807			
737800	ICAO_A	1	7	Accelerate	MaxClimb	T_00		1 896,8	250	
737800	ICAO_A	1	8	Climb	MaxClimb	T_00	5 500			
737800	ICAO_A	1	9	Climb	MaxClimb	T_00	7 500			
737800	ICAO_A	1	10	Climb	MaxClimb	T_00	10 000			
737800	ICAO_A	2	1	Takeoff	MaxTakeoff	T_05				
737800	ICAO_A	2	2	Climb	MaxTakeoff	T_05	1 500			
737800	ICAO_A	2	3	Climb	MaxClimb	T_05	3 000			
737800	ICAO_A	2	4	Accelerate	MaxClimb	T_05		1 372,3	179,6	
737800	ICAO_A	2	5	Accelerate	MaxClimb	T_01		1 579,3	207,8	

ACFTID	Profile_ID	Stage Length	Step Number	Step Type	Thrust Rating	Flap_ID	End Point Altitude (ft)	Rate Of Climb (ft/min)	End Point CAS (kt)	Accelerate_Percent (%)
737800	ICAO_A	2	6	Climb	MaxClimb	T_00	3 772			
737800	ICAO_A	2	7	Accelerate	MaxClimb	T_00		1 804,3	250	
737800	ICAO_A	2	8	Climb	MaxClimb	T_00	5 500			
737800	ICAO_A	2	9	Climb	MaxClimb	T_00	7 500			
737800	ICAO_A	2	10	Climb	MaxClimb	T_00	10 000			
737800	ICAO_A	3	1	Takeoff	MaxTakeoff	T_05				
737800	ICAO_A	3	2	Climb	MaxTakeoff	T_05	1 500			
737800	ICAO_A	3	3	Climb	MaxClimb	T_05	3 000			
737800	ICAO_A	3	4	Accelerate	MaxClimb	T_05		1 297	182,1	
737800	ICAO_A	3	5	Accelerate	MaxClimb	T_01		1 496,9	211	
737800	ICAO_A	3	6	Climb	MaxClimb	T_00	3 737			
737800	ICAO_A	3	7	Accelerate	MaxClimb	T_00		1 701,8	250	
737800	ICAO_A	3	8	Climb	MaxClimb	T_00	5 500			
737800	ICAO_A	3	9	Climb	MaxClimb	T_00	7 500			
737800	ICAO_A	3	10	Climb	MaxClimb	T_00	10 000			
737800	ICAO_A	4	1	Takeoff	MaxTakeoff	T_05				
737800	ICAO_A	4	2	Climb	MaxTakeoff	T_05	1 500			
737800	ICAO_A	4	3	Climb	MaxClimb	T_05	3 000			
737800	ICAO_A	4	4	Accelerate	MaxClimb	T_05		1 194,2	185,8	
737800	ICAO_A	4	5	Accelerate	MaxClimb	T_01		1 352,1	214,8	

ACFTID	Profile_ID	Stage Length	Step Number	Step Type	Thrust Rating	Flap_ID	End Point Altitude (ft)	Rate Of Climb (ft/min)	End Point CAS (kt)	Accelerate_Percent (%)
737800	ICAO_A	4	6	Accelerate	MaxClimb	T_00		1 548,2	250	
737800	ICAO_A	4	7	Climb	MaxClimb	T_00	5 500			
737800	ICAO_A	4	8	Climb	MaxClimb	T_00	7 500			
737800	ICAO_A	4	9	Climb	MaxClimb	T_00	10 000			
737800	ICAO_A	5	1	Takeoff	MaxTakeoff	T_05				
737800	ICAO_A	5	2	Climb	MaxTakeoff	T_05	1 500			
737800	ICAO_A	5	3	Climb	MaxClimb	T_05	3 000			
737800	ICAO_A	5	4	Accelerate	MaxClimb	T_05		1 078,9	189,4	
737800	ICAO_A	5	5	Accelerate	MaxClimb	T_01		1 233,3	217,4	
737800	ICAO_A	5	6	Accelerate	MaxClimb	T_00		1 403,6	250	
737800	ICAO_A	5	7	Climb	MaxClimb	T_00	5 500			
737800	ICAO_A	5	8	Climb	MaxClimb	T_00	7 500			
737800	ICAO_A	5	9	Climb	MaxClimb	T_00	10 000			
737800	ICAO_A	6	1	Takeoff	MaxTakeoff	T_05				
737800	ICAO_A	6	2	Climb	MaxTakeoff	T_05	1 500			
737800	ICAO_A	6	3	Climb	MaxClimb	T_05	3 000			
737800	ICAO_A	6	4	Accelerate	MaxClimb	T_05		1 037,8	190,9	
737800	ICAO_A	6	5	Accelerate	MaxClimb	T_01		1 182,7	218,6	
737800	ICAO_A	6	6	Accelerate	MaxClimb	T_00		1 349,5	250	
737800	ICAO_A	6	7	Climb	MaxClimb	T_00	5 500			

ACFTID	Profile_ID	Stage Length	Step Number	Step Type	Thrust Rating	Flap_ID	End Point Altitude (ft)	Rate Of Climb (ft/min)	End Point CAS (kt)	Accelerate_Percent (%)
737800	ICAO_A	6	8	Climb	MaxClimb	T_00	7 500			
737800	ICAO_A	6	9	Climb	MaxClimb	T_00	10 000			
737800	ICAO_B	1	1	Takeoff	MaxTakeoff	T_05				
737800	ICAO_B	1	2	Climb	MaxTakeoff	T_05	1 000			
737800	ICAO_B	1	3	Accelerate	MaxTakeoff	T_05		1 885,7	181,7	
737800	ICAO_B	1	4	Accelerate	MaxTakeoff	T_01		2 112	204,8	
737800	ICAO_B	1	5	Climb	MaxTakeoff	T_00	2 040			
737800	ICAO_B	1	6	Climb	MaxClimb	T_00	3 000			
737800	ICAO_B	1	7	Accelerate	MaxClimb	T_00		1 891,3	250	
737800	ICAO_B	1	8	Climb	MaxClimb	T_00	5 500			
737800	ICAO_B	1	9	Climb	MaxClimb	T_00	7 500			
737800	ICAO_B	1	10	Climb	MaxClimb	T_00	10 000			
737800	ICAO_B	2	1	Takeoff	MaxTakeoff	T_05				
737800	ICAO_B	2	2	Climb	MaxTakeoff	T_05	1 000			
737800	ICAO_B	2	3	Accelerate	MaxTakeoff	T_05		1 786,4	183,9	
737800	ICAO_B	2	4	Accelerate	MaxTakeoff	T_01		2 016,2	208	
737800	ICAO_B	2	5	Climb	MaxTakeoff	T_00	2 000			
737800	ICAO_B	2	6	Climb	MaxClimb	T_00	3 000			
737800	ICAO_B	2	7	Accelerate	MaxClimb	T_00		1 793,4	250	
737800	ICAO_B	2	8	Climb	MaxClimb	T_00	5 500			

ACFTID	Profile_ID	Stage Length	Step Number	Step Type	Thrust Rating	Flap_ID	End Point Altitude (ft)	Rate Of Climb (ft/min)	End Point CAS (kt)	Accelerate_Percent (%)
737800	ICAO_B	2	9	Climb	MaxClimb	T_00	7 500			
737800	ICAO_B	2	10	Climb	MaxClimb	T_00	10 000			
737800	ICAO_B	3	1	Takeoff	MaxTakeoff	T_05				
737800	ICAO_B	3	2	Climb	MaxTakeoff	T_05	1 000			
737800	ICAO_B	3	3	Accelerate	MaxTakeoff	T_05		1 707,7	186,2	
737800	ICAO_B	3	4	Accelerate	MaxTakeoff	T_05		1 922	211,2	
737800	ICAO_B	3	5	Climb	MaxTakeoff	T_00	1 960			
737800	ICAO_B	3	6	Climb	MaxClimb	T_00	3 000			
737800	ICAO_B	3	7	Accelerate	MaxClimb	T_00		1 705,3	250	
737800	ICAO_B	3	8	Climb	MaxClimb	T_00	5 500			
737800	ICAO_B	3	9	Climb	MaxClimb	T_00	7 500			
737800	ICAO_B	3	10	Climb	MaxClimb	T_00	10 000			
737800	ICAO_B	4	1	Takeoff	MaxTakeoff	T_05				
737800	ICAO_B	4	2	Climb	MaxTakeoff	T_05	1 000			
737800	ICAO_B	4	3	Accelerate	MaxTakeoff	T_05		1 576,6	189,6	
737800	ICAO_B	4	4	Accelerate	MaxTakeoff	T_01		1 766,9	216,2	
737800	ICAO_B	4	5	Climb	MaxTakeoff	T_00	1 880			
737800	ICAO_B	4	6	Climb	MaxClimb	T_00	3 000			
737800	ICAO_B	4	7	Accelerate	MaxClimb	T_00		1 546,5	250	
737800	ICAO_B	4	8	Climb	MaxClimb	T_00	5 500			

ACFTID	Profile_ID	Stage Length	Step Number	Step Type	Thrust Rating	Flap_ID	End Point Altitude (ft)	Rate Of Climb (ft/min)	End Point CAS (kt)	Accelerate_Percent (%)
737800	ICAO_B	4	9	Climb	MaxClimb	T_00	7 500			
737800	ICAO_B	4	10	Climb	MaxClimb	T_00	10 000			
737800	ICAO_B	5	1	Takeoff	MaxTakeoff	T_05				
737800	ICAO_B	5	2	Climb	MaxTakeoff	T_05	1 000			
737800	ICAO_B	5	3	Accelerate	MaxTakeoff	T_05		1 444,9	192,9	
737800	ICAO_B	5	4	Accelerate	MaxTakeoff	T_01		1 628,6	220,7	
737800	ICAO_B	5	5	Climb	MaxTakeoff	T_00	1 811			
737800	ICAO_B	5	6	Climb	MaxClimb	T_00	3 000			
737800	ICAO_B	5	7	Accelerate	MaxClimb	T_00		1 412,2	250	
737800	ICAO_B	5	8	Climb	MaxClimb	T_00	5 500			
737800	ICAO_B	5	9	Climb	MaxClimb	T_00	7 500			
737800	ICAO_B	5	10	Climb	MaxClimb	T_00	10 000			
737800	ICAO_B	6	1	Takeoff	MaxTakeoff	T_05				
737800	ICAO_B	6	2	Climb	MaxTakeoff	T_05	1 000			
737800	ICAO_B	6	3	Accelerate	MaxTakeoff	T_05		1 400	194,4	
737800	ICAO_B	6	4	Accelerate	MaxTakeoff	T_01		1 575,4	222,7	
737800	ICAO_B	6	5	Climb	MaxTakeoff	T_00	1 785			
737800	ICAO_B	6	6	Climb	MaxClimb	T_00	3 000			
737800	ICAO_B	6	7	Accelerate	MaxClimb	T_00		1 357,5	250	
737800	ICAO_B	6	8	Climb	MaxClimb	T_00	5 500			

ACFTID	Profile_ID	Stage Length	Step Number	Step Type	Thrust Rating	Flap_ID	End Point Altitude (ft)	Rate Of Climb (ft/min)	End Point CAS (kt)	Accelerate_Percent (%)
737800	ICAO_B	6	9	Climb	MaxClimb	T_00	7 500			
737800	ICAO_B	6	10	Climb	MaxClimb	T_00	10 000			
737D17	DEFAULT	1	1	Takeoff	MaxTakeoff	5				
737D17	DEFAULT	1	2	Climb	MaxTakeoff	5	1 000			
737D17	DEFAULT	1	3	Accelerate	MaxTakeoff	5		2 279	152	
737D17	DEFAULT	1	4	Accelerate	MaxTakeoff	INT		1 709	177	
737D17	DEFAULT	1	5	Accelerate	MaxClimb	ZERO		1 000	210	
737D17	DEFAULT	1	6	Climb	MaxClimb	ZERO	3 000			
737D17	DEFAULT	1	7	Accelerate	MaxClimb	ZERO		1 000	250	
737D17	DEFAULT	1	8	Climb	MaxClimb	ZERO	5 500			
737D17	DEFAULT	1	9	Climb	MaxClimb	ZERO	7 500			
737D17	DEFAULT	1	10	Climb	MaxClimb	ZERO	10 000			
737D17	DEFAULT	2	1	Takeoff	MaxTakeoff	5				
737D17	DEFAULT	2	2	Climb	MaxTakeoff	5	1 000			
737D17	DEFAULT	2	3	Accelerate	MaxTakeoff	5		2 155	156	
737D17	DEFAULT	2	4	Accelerate	MaxTakeoff	INT		1 616	181	
737D17	DEFAULT	2	5	Accelerate	MaxClimb	ZERO		1 000	210	
737D17	DEFAULT	2	6	Climb	MaxClimb	ZERO	3 000			
737D17	DEFAULT	2	7	Accelerate	MaxClimb	ZERO		1 000	250	
737D17	DEFAULT	2	8	Climb	MaxClimb	ZERO	5 500			

ACFTID	Profile_ID	Stage Length	Step Number	Step Type	Thrust Rating	Flap_ID	End Point Altitude (ft)	Rate Of Climb (ft/min)	End Point CAS (kt)	Accelerate_Percent (%)
737D17	DEFAULT	2	9	Climb	MaxClimb	ZERO	7 500			
737D17	DEFAULT	2	10	Climb	MaxClimb	ZERO	10 000			
737D17	DEFAULT	3	1	Takeoff	MaxTakeoff	5				
737D17	DEFAULT	3	2	Climb	MaxTakeoff	5	1 000			
737D17	DEFAULT	3	3	Accelerate	MaxTakeoff	5		2 041	160	
737D17	DEFAULT	3	4	Accelerate	MaxTakeoff	INT		1 531	185	
737D17	DEFAULT	3	5	Accelerate	MaxClimb	ZERO		1 000	210	
737D17	DEFAULT	3	6	Climb	MaxClimb	ZERO	3 000			
737D17	DEFAULT	3	7	Accelerate	MaxClimb	ZERO		1 000	250	
737D17	DEFAULT	3	8	Climb	MaxClimb	ZERO	5 500			
737D17	DEFAULT	3	9	Climb	MaxClimb	ZERO	7 500			
737D17	DEFAULT	3	10	Climb	MaxClimb	ZERO	10 000			
737D17	DEFAULT	4	1	Takeoff	MaxTakeoff	5				
737D17	DEFAULT	4	2	Climb	MaxTakeoff	5	1 000			
737D17	DEFAULT	4	3	Accelerate	MaxTakeoff	5		1 935	163	
737D17	DEFAULT	4	4	Accelerate	MaxTakeoff	INT		1 452	188	
737D17	DEFAULT	4	5	Accelerate	MaxClimb	ZERO		1 000	210	
737D17	DEFAULT	4	6	Climb	MaxClimb	ZERO	3 000			
737D17	DEFAULT	4	7	Accelerate	MaxClimb	ZERO		1 000	250	
737D17	DEFAULT	4	8	Climb	MaxClimb	ZERO	5 500			

ACFTID	Profile_ID	Stage Length	Step Number	Step Type	Thrust Rating	Flap_ID	End Point Altitude (ft)	Rate Of Climb (ft/min)	End Point CAS (kt)	Accelerate_Percent (%)
737D17	DEFAULT	4	9	Climb	MaxClimb	ZERO	7 500			
737D17	DEFAULT	4	10	Climb	MaxClimb	ZERO	10 000			
737N17	DEFAULT	1	1	Takeoff	MaxTakeoff	5				
737N17	DEFAULT	1	2	Climb	MaxTakeoff	5	1 000			
737N17	DEFAULT	1	3	Accelerate	MaxTakeoff	5		2 279	152	
737N17	DEFAULT	1	4	Accelerate	MaxTakeoff	INT		1 709	177	
737N17	DEFAULT	1	5	Accelerate	MaxClimb	ZERO		1 000	210	
737N17	DEFAULT	1	6	Climb	MaxClimb	ZERO	3 000			
737N17	DEFAULT	1	7	Accelerate	MaxClimb	ZERO		1 000	250	
737N17	DEFAULT	1	8	Climb	MaxClimb	ZERO	5 500			
737N17	DEFAULT	1	9	Climb	MaxClimb	ZERO	7 500			
737N17	DEFAULT	1	10	Climb	MaxClimb	ZERO	10 000			
737N17	DEFAULT	2	1	Takeoff	MaxTakeoff	5				
737N17	DEFAULT	2	2	Climb	MaxTakeoff	5	1 000			
737N17	DEFAULT	2	3	Accelerate	MaxTakeoff	5		2 155	156	
737N17	DEFAULT	2	4	Accelerate	MaxTakeoff	INT		1 616	181	
737N17	DEFAULT	2	5	Accelerate	MaxClimb	ZERO		1 000	210	
737N17	DEFAULT	2	6	Climb	MaxClimb	ZERO	3 000			
737N17	DEFAULT	2	7	Accelerate	MaxClimb	ZERO		1 000	250	
737N17	DEFAULT	2	8	Climb	MaxClimb	ZERO	5 500			

ACFTID	Profile_ID	Stage Length	Step Number	Step Type	Thrust Rating	Flap_ID	End Point Altitude (ft)	Rate Of Climb (ft/min)	End Point CAS (kt)	Accelerate_Percent (%)
737N17	DEFAULT	2	9	Climb	MaxClimb	ZERO	7 500			
737N17	DEFAULT	2	10	Climb	MaxClimb	ZERO	10 000			
737N17	DEFAULT	3	1	Takeoff	MaxTakeoff	5				
737N17	DEFAULT	3	2	Climb	MaxTakeoff	5	1 000			
737N17	DEFAULT	3	3	Accelerate	MaxTakeoff	5		2 041	160	
737N17	DEFAULT	3	4	Accelerate	MaxTakeoff	INT		1 531	185	
737N17	DEFAULT	3	5	Accelerate	MaxClimb	ZERO		1 000	210	
737N17	DEFAULT	3	6	Climb	MaxClimb	ZERO	3 000			
737N17	DEFAULT	3	7	Accelerate	MaxClimb	ZERO		1 000	250	
737N17	DEFAULT	3	8	Climb	MaxClimb	ZERO	5 500			
737N17	DEFAULT	3	9	Climb	MaxClimb	ZERO	7 500			
737N17	DEFAULT	3	10	Climb	MaxClimb	ZERO	10 000			
737N17	DEFAULT	4	1	Takeoff	MaxTakeoff	5				
737N17	DEFAULT	4	2	Climb	MaxTakeoff	5	1 000			
737N17	DEFAULT	4	3	Accelerate	MaxTakeoff	5		1 935	163	
737N17	DEFAULT	4	4	Accelerate	MaxTakeoff	INT		1 452	188	
737N17	DEFAULT	4	5	Accelerate	MaxClimb	ZERO		1 000	210	
737N17	DEFAULT	4	6	Climb	MaxClimb	ZERO	3 000			
737N17	DEFAULT	4	7	Accelerate	MaxClimb	ZERO		1 000	250	
737N17	DEFAULT	4	8	Climb	MaxClimb	ZERO	5 500			

ACFTID	Profile_ID	Stage Length	Step Number	Step Type	Thrust Rating	Flap_ID	End Point Altitude (ft)	Rate Of Climb (ft/min)	End Point CAS (kt)	Accelerate_Percent (%)
737N17	DEFAULT	4	9	Climb	MaxClimb	ZERO	7 500			
737N17	DEFAULT	4	10	Climb	MaxClimb	ZERO	10 000			
737N9	DEFAULT	1	1	Takeoff	MaxTakeoff	5				
737N9	DEFAULT	1	2	Climb	MaxTakeoff	5	1 000			
737N9	DEFAULT	1	3	Accelerate	MaxTakeoff	5		2 090	146	
737N9	DEFAULT	1	4	Accelerate	MaxTakeoff	INT		1 568	171	
737N9	DEFAULT	1	5	Accelerate	MaxClimb	ZERO		1 000	210	
737N9	DEFAULT	1	6	Climb	MaxClimb	ZERO	3 000			
737N9	DEFAULT	1	7	Accelerate	MaxClimb	ZERO		1 000	250	
737N9	DEFAULT	1	8	Climb	MaxClimb	ZERO	5 500			
737N9	DEFAULT	1	9	Climb	MaxClimb	ZERO	7 500			
737N9	DEFAULT	1	10	Climb	MaxClimb	ZERO	10 000			
737N9	DEFAULT	2	1	Takeoff	MaxTakeoff	5				
737N9	DEFAULT	2	2	Climb	MaxTakeoff	5	1 000			
737N9	DEFAULT	2	3	Accelerate	MaxTakeoff	5		2 014	149	
737N9	DEFAULT	2	4	Accelerate	MaxTakeoff	INT		1 511	174	
737N9	DEFAULT	2	5	Accelerate	MaxClimb	ZERO		1 000	210	
737N9	DEFAULT	2	6	Climb	MaxClimb	ZERO	3 000			
737N9	DEFAULT	2	7	Accelerate	MaxClimb	ZERO		1 000	250	
737N9	DEFAULT	2	8	Climb	MaxClimb	ZERO	5 500			

ACFTID	Profile_ID	Stage Length	Step Number	Step Type	Thrust Rating	Flap_ID	End Point Altitude (ft)	Rate Of Climb (ft/min)	End Point CAS (kt)	Accelerate_Percent (%)
737N9	DEFAULT	2	9	Climb	MaxClimb	ZERO	7 500			
737N9	DEFAULT	2	10	Climb	MaxClimb	ZERO	10 000			
737N9	DEFAULT	3	1	Takeoff	MaxTakeoff	5				
737N9	DEFAULT	3	2	Climb	MaxTakeoff	5	1 000			
737N9	DEFAULT	3	3	Accelerate	MaxTakeoff	5		1 851	154	
737N9	DEFAULT	3	4	Accelerate	MaxTakeoff	INT		1 388	179	
737N9	DEFAULT	3	5	Accelerate	MaxClimb	ZERO		1 000	210	
737N9	DEFAULT	3	6	Climb	MaxClimb	ZERO	3 000			
737N9	DEFAULT	3	7	Accelerate	MaxClimb	ZERO		1 000	250	
737N9	DEFAULT	3	8	Climb	MaxClimb	ZERO	5 500			
737N9	DEFAULT	3	9	Climb	MaxClimb	ZERO	7 500			
737N9	DEFAULT	3	10	Climb	MaxClimb	ZERO	10 000			
737N9	DEFAULT	4	1	Takeoff	MaxTakeoff	5				
737N9	DEFAULT	4	2	Climb	MaxTakeoff	5	1 000			
737N9	DEFAULT	4	3	Accelerate	MaxTakeoff	5		1 685	160	
737N9	DEFAULT	4	4	Accelerate	MaxTakeoff	INT		1 264	185	
737N9	DEFAULT	4	5	Accelerate	MaxClimb	ZERO		1 000	210	
737N9	DEFAULT	4	6	Climb	MaxClimb	ZERO	3 000			
737N9	DEFAULT	4	7	Accelerate	MaxClimb	ZERO		1 000	250	
737N9	DEFAULT	4	8	Climb	MaxClimb	ZERO	5 500			

ACFTID	Profile_ID	Stage Length	Step Number	Step Type	Thrust Rating	Flap_ID	End Point Altitude (ft)	Rate Of Climb (ft/min)	End Point CAS (kt)	Accelerate_Percent (%)
737N9	DEFAULT	4	9	Climb	MaxClimb	ZERO	7 500			
737N9	DEFAULT	4	10	Climb	MaxClimb	ZERO	10 000			
737QN	DEFAULT	1	1	Takeoff	MaxTakeoff	5				
737QN	DEFAULT	1	2	Climb	MaxTakeoff	5	1 000			
737QN	DEFAULT	1	3	Accelerate	MaxTakeoff	5		2 090	146	
737QN	DEFAULT	1	4	Accelerate	MaxTakeoff	INT		1 568	171	
737QN	DEFAULT	1	5	Accelerate	MaxClimb	ZERO		1 000	210	
737QN	DEFAULT	1	6	Climb	MaxClimb	ZERO	3 000			
737QN	DEFAULT	1	7	Accelerate	MaxClimb	ZERO		1 000	250	
737QN	DEFAULT	1	8	Climb	MaxClimb	ZERO	5 500			
737QN	DEFAULT	1	9	Climb	MaxClimb	ZERO	7 500			
737QN	DEFAULT	1	10	Climb	MaxClimb	ZERO	10 000			
737QN	DEFAULT	2	1	Takeoff	MaxTakeoff	5				
737QN	DEFAULT	2	2	Climb	MaxTakeoff	5	1 000			
737QN	DEFAULT	2	3	Accelerate	MaxTakeoff	5		2 014	149	
737QN	DEFAULT	2	4	Accelerate	MaxTakeoff	INT		1 511	174	
737QN	DEFAULT	2	5	Accelerate	MaxClimb	ZERO		1 000	210	
737QN	DEFAULT	2	6	Climb	MaxClimb	ZERO	3 000			
737QN	DEFAULT	2	7	Accelerate	MaxClimb	ZERO		1 000	250	
737QN	DEFAULT	2	8	Climb	MaxClimb	ZERO	5 500			

ACFTID	Profile_ID	Stage Length	Step Number	Step Type	Thrust Rating	Flap_ID	End Point Altitude (ft)	Rate Of Climb (ft/min)	End Point CAS (kt)	Accelerate_Percent (%)
737QN	DEFAULT	2	9	Climb	MaxClimb	ZERO	7 500			
737QN	DEFAULT	2	10	Climb	MaxClimb	ZERO	10 000			
737QN	DEFAULT	3	1	Takeoff	MaxTakeoff	5				
737QN	DEFAULT	3	2	Climb	MaxTakeoff	5	1 000			
737QN	DEFAULT	3	3	Accelerate	MaxTakeoff	5		1 851	154	
737QN	DEFAULT	3	4	Accelerate	MaxTakeoff	INT		1 388	179	
737QN	DEFAULT	3	5	Accelerate	MaxClimb	ZERO		1 000	210	
737QN	DEFAULT	3	6	Climb	MaxClimb	ZERO	3 000			
737QN	DEFAULT	3	7	Accelerate	MaxClimb	ZERO		1 000	250	
737QN	DEFAULT	3	8	Climb	MaxClimb	ZERO	5 500			
737QN	DEFAULT	3	9	Climb	MaxClimb	ZERO	7 500			
737QN	DEFAULT	3	10	Climb	MaxClimb	ZERO	10 000			
737QN	DEFAULT	4	1	Takeoff	MaxTakeoff	5				
737QN	DEFAULT	4	2	Climb	MaxTakeoff	5	1 000			
737QN	DEFAULT	4	3	Accelerate	MaxTakeoff	5		1 685	160	
737QN	DEFAULT	4	4	Accelerate	MaxTakeoff	INT		1 264	185	
737QN	DEFAULT	4	5	Accelerate	MaxClimb	ZERO		1 000	210	
737QN	DEFAULT	4	6	Climb	MaxClimb	ZERO	3 000			
737QN	DEFAULT	4	7	Accelerate	MaxClimb	ZERO		1 000	250	
737QN	DEFAULT	4	8	Climb	MaxClimb	ZERO	5 500			

ACFTID	Profile_ID	Stage Length	Step Number	Step Type	Thrust Rating	Flap_ID	End Point Altitude (ft)	Rate Of Climb (ft/min)	End Point CAS (kt)	Accelerate_Percent (%)
737QN	DEFAULT	4	9	Climb	MaxClimb	ZERO	7 500			
737QN	DEFAULT	4	10	Climb	MaxClimb	ZERO	10 000			
74710Q	DEFAULT	1	1	Takeoff	MaxTakeoff	10				
74710Q	DEFAULT	1	2	Climb	MaxTakeoff	10	1 000			
74710Q	DEFAULT	1	3	Accelerate	MaxTakeoff	10		2 071	176	
74710Q	DEFAULT	1	4	Accelerate	MaxClimb	5		1 000	216	
74710Q	DEFAULT	1	5	Climb	MaxClimb	ZERO	3 000			
74710Q	DEFAULT	1	6	Accelerate	MaxClimb	ZERO		1 000	250	
74710Q	DEFAULT	1	7	Climb	MaxClimb	ZERO	5 500			
74710Q	DEFAULT	1	8	Climb	MaxClimb	ZERO	7 500			
74710Q	DEFAULT	1	9	Climb	MaxClimb	ZERO	10 000			
74710Q	DEFAULT	2	1	Takeoff	MaxTakeoff	10				
74710Q	DEFAULT	2	2	Climb	MaxTakeoff	10	1 000			
74710Q	DEFAULT	2	3	Accelerate	MaxTakeoff	10		1 972	179	
74710Q	DEFAULT	2	4	Accelerate	MaxClimb	5		1 000	219	
74710Q	DEFAULT	2	5	Climb	MaxClimb	ZERO	3 000			
74710Q	DEFAULT	2	6	Accelerate	MaxClimb	ZERO		1 000	250	
74710Q	DEFAULT	2	7	Climb	MaxClimb	ZERO	5 500			
74710Q	DEFAULT	2	8	Climb	MaxClimb	ZERO	7 500			
74710Q	DEFAULT	2	9	Climb	MaxClimb	ZERO	10 000			

ACFTID	Profile_ID	Stage Length	Step Number	Step Type	Thrust Rating	Flap_ID	End Point Altitude (ft)	Rate Of Climb (ft/min)	End Point CAS (kt)	Accelerate_Percent (%)
74710Q	DEFAULT	3	1	Takeoff	MaxTakeoff	10				
74710Q	DEFAULT	3	2	Climb	MaxTakeoff	10	1 000			
74710Q	DEFAULT	3	3	Accelerate	MaxTakeoff	10		1 856	183	
74710Q	DEFAULT	3	4	Accelerate	MaxClimb	5		1 000	223	
74710Q	DEFAULT	3	5	Climb	MaxClimb	ZERO	3 000			
74710Q	DEFAULT	3	6	Accelerate	MaxClimb	ZERO		1 000	250	
74710Q	DEFAULT	3	7	Climb	MaxClimb	ZERO	5 500			
74710Q	DEFAULT	3	8	Climb	MaxClimb	ZERO	7 500			
74710Q	DEFAULT	3	9	Climb	MaxClimb	ZERO	10 000			
74710Q	DEFAULT	4	1	Takeoff	MaxTakeoff	10				
74710Q	DEFAULT	4	2	Climb	MaxTakeoff	10	1 000			
74710Q	DEFAULT	4	3	Accelerate	MaxTakeoff	10		1 727	187	
74710Q	DEFAULT	4	4	Accelerate	MaxClimb	5		1 000	227	
74710Q	DEFAULT	4	5	Climb	MaxClimb	ZERO	3 000			
74710Q	DEFAULT	4	6	Accelerate	MaxClimb	ZERO		1 000	250	
74710Q	DEFAULT	4	7	Climb	MaxClimb	ZERO	5 500			
74710Q	DEFAULT	4	8	Climb	MaxClimb	ZERO	7 500			
74710Q	DEFAULT	4	9	Climb	MaxClimb	ZERO	10 000			
74710Q	DEFAULT	5	1	Takeoff	MaxTakeoff	10				
74710Q	DEFAULT	5	2	Climb	MaxTakeoff	10	1 000			

ACFTID	Profile_ID	Stage Length	Step Number	Step Type	Thrust Rating	Flap_ID	End Point Altitude (ft)	Rate Of Climb (ft/min)	End Point CAS (kt)	Accelerate_Percent (%)
74710Q	DEFAULT	5	3	Accelerate	MaxTakeoff	10		1 445	198	
74710Q	DEFAULT	5	4	Accelerate	MaxClimb	5		750	238	
74710Q	DEFAULT	5	5	Climb	MaxClimb	ZERO	3 000			
74710Q	DEFAULT	5	6	Accelerate	MaxClimb	ZERO		750	258	
74710Q	DEFAULT	5	7	Climb	MaxClimb	ZERO	5 500			
74710Q	DEFAULT	5	8	Climb	MaxClimb	ZERO	7 500			
74710Q	DEFAULT	5	9	Climb	MaxClimb	ZERO	10 000			
74710Q	DEFAULT	6	1	Takeoff	MaxTakeoff	10				
74710Q	DEFAULT	6	2	Climb	MaxTakeoff	10	1 000			
74710Q	DEFAULT	6	3	Accelerate	MaxTakeoff	10		1 411	199	
74710Q	DEFAULT	6	4	Accelerate	MaxClimb	5		750	239	
74710Q	DEFAULT	6	5	Climb	MaxClimb	ZERO	3 000			
74710Q	DEFAULT	6	6	Accelerate	MaxClimb	ZERO		750	259	
74710Q	DEFAULT	6	7	Climb	MaxClimb	ZERO	5 500			
74710Q	DEFAULT	6	8	Climb	MaxClimb	ZERO	7 500			
74710Q	DEFAULT	6	9	Climb	MaxClimb	ZERO	10 000			
747200	DEFAULT	1	1	Takeoff	MaxTakeoff	10				
747200	DEFAULT	1	2	Climb	MaxTakeoff	10	1 000			
747200	DEFAULT	1	3	Accelerate	MaxTakeoff	10		1 842	183	
747200	DEFAULT	1	4	Accelerate	MaxClimb	5		1 000	223	

ACFTID	Profile_ID	Stage Length	Step Number	Step Type	Thrust Rating	Flap_ID	End Point Altitude (ft)	Rate Of Climb (ft/min)	End Point CAS (kt)	Accelerate_Percent (%)
747200	DEFAULT	1	5	Climb	MaxClimb	ZERO	3 000			
747200	DEFAULT	1	6	Accelerate	MaxClimb	ZERO		1 000	250	
747200	DEFAULT	1	7	Climb	MaxClimb	ZERO	5 500			
747200	DEFAULT	1	8	Climb	MaxClimb	ZERO	7 500			
747200	DEFAULT	1	9	Climb	MaxClimb	ZERO	10 000			
747200	DEFAULT	2	1	Takeoff	MaxTakeoff	10				
747200	DEFAULT	2	2	Climb	MaxTakeoff	10	1 000			
747200	DEFAULT	2	3	Accelerate	MaxTakeoff	10		1 757	186	
747200	DEFAULT	2	4	Accelerate	MaxClimb	5		1 000	226	
747200	DEFAULT	2	5	Climb	MaxClimb	ZERO	3 000			
747200	DEFAULT	2	6	Accelerate	MaxClimb	ZERO		1 000	250	
747200	DEFAULT	2	7	Climb	MaxClimb	ZERO	5 500			
747200	DEFAULT	2	8	Climb	MaxClimb	ZERO	7 500			
747200	DEFAULT	2	9	Climb	MaxClimb	ZERO	10 000			
747200	DEFAULT	3	1	Takeoff	MaxTakeoff	10				
747200	DEFAULT	3	2	Climb	MaxTakeoff	10	1 000			
747200	DEFAULT	3	3	Accelerate	MaxTakeoff	10		1 676	189	
747200	DEFAULT	3	4	Accelerate	MaxClimb	5		1 000	229	
747200	DEFAULT	3	5	Climb	MaxClimb	ZERO	3 000			
747200	DEFAULT	3	6	Accelerate	MaxClimb	ZERO		1 000	250	

ACFTID	Profile_ID	Stage Length	Step Number	Step Type	Thrust Rating	Flap_ID	End Point Altitude (ft)	Rate Of Climb (ft/min)	End Point CAS (kt)	Accelerate_Percent (%)
747200	DEFAULT	3	7	Climb	MaxClimb	ZERO	5 500			
747200	DEFAULT	3	8	Climb	MaxClimb	ZERO	7 500			
747200	DEFAULT	3	9	Climb	MaxClimb	ZERO	10 000			
747200	DEFAULT	4	1	Takeoff	MaxTakeoff	10				
747200	DEFAULT	4	2	Climb	MaxTakeoff	10	1 000			
747200	DEFAULT	4	3	Accelerate	MaxTakeoff	10		1 508	195	
747200	DEFAULT	4	4	Accelerate	MaxClimb	5		750	235	
747200	DEFAULT	4	5	Climb	MaxClimb	ZERO	3 000			
747200	DEFAULT	4	6	Accelerate	MaxClimb	ZERO		750	255	
747200	DEFAULT	4	7	Climb	MaxClimb	ZERO	5 500			
747200	DEFAULT	4	8	Climb	MaxClimb	ZERO	7 500			
747200	DEFAULT	4	9	Climb	MaxClimb	ZERO	10 000			
747200	DEFAULT	5	1	Takeoff	MaxTakeoff	10				
747200	DEFAULT	5	2	Climb	MaxTakeoff	10	1 000			
747200	DEFAULT	5	3	Accelerate	MaxTakeoff	10		1 325	203	
747200	DEFAULT	5	4	Accelerate	MaxClimb	5		750	243	
747200	DEFAULT	5	5	Climb	MaxClimb	ZERO	3 000			
747200	DEFAULT	5	6	Accelerate	MaxClimb	ZERO		750	263	
747200	DEFAULT	5	7	Climb	MaxClimb	ZERO	5 500			
747200	DEFAULT	5	8	Climb	MaxClimb	ZERO	7 500			

ACFTID	Profile_ID	Stage Length	Step Number	Step Type	Thrust Rating	Flap_ID	End Point Altitude (ft)	Rate Of Climb (ft/min)	End Point CAS (kt)	Accelerate_Percent (%)
747200	DEFAULT	5	9	Climb	MaxClimb	ZERO	10 000			
747200	DEFAULT	6	1	Takeoff	MaxTakeoff	10				
747200	DEFAULT	6	2	Climb	MaxTakeoff	10	1 000			
747200	DEFAULT	6	3	Accelerate	MaxTakeoff	10		1 146	210	
747200	DEFAULT	6	4	Accelerate	MaxClimb	5		500	250	
747200	DEFAULT	6	5	Climb	MaxClimb	ZERO	3 000			
747200	DEFAULT	6	6	Accelerate	MaxClimb	ZERO		500	270	
747200	DEFAULT	6	7	Climb	MaxClimb	ZERO	5 500			
747200	DEFAULT	6	8	Climb	MaxClimb	ZERO	7 500			
747200	DEFAULT	6	9	Climb	MaxClimb	ZERO	10 000			
747200	DEFAULT	7	1	Takeoff	MaxTakeoff	10				
747200	DEFAULT	7	2	Climb	MaxTakeoff	10	1 000			
747200	DEFAULT	7	3	Accelerate	MaxTakeoff	10		1 012	216	
747200	DEFAULT	7	4	Accelerate	MaxClimb	5		500	256	
747200	DEFAULT	7	5	Accelerate	MaxClimb	ZERO		500	276	
747200	DEFAULT	7	6	Climb	MaxClimb	ZERO	5 500			
747200	DEFAULT	7	7	Climb	MaxClimb	ZERO	7 500			
747200	DEFAULT	7	8	Climb	MaxClimb	ZERO	10 000			
74720A	DEFAULT	1	1	Takeoff	MaxTakeoff	10				
74720A	DEFAULT	1	2	Climb	MaxTakeoff	10	1 000			

ACFTID	Profile_ID	Stage Length	Step Number	Step Type	Thrust Rating	Flap_ID	End Point Altitude (ft)	Rate Of Climb (ft/min)	End Point CAS (kt)	Accelerate_Percent (%)
74720A	DEFAULT	1	3	Accelerate	MaxTakeoff	10		2 068	176	
74720A	DEFAULT	1	4	Accelerate	MaxClimb	5		1 000	239	
74720A	DEFAULT	1	5	Climb	MaxClimb	ZERO	3 000			
74720A	DEFAULT	1	6	Accelerate	MaxClimb	ZERO		1 000	259	
74720A	DEFAULT	1	7	Climb	MaxClimb	ZERO	5 500			
74720A	DEFAULT	1	8	Climb	MaxClimb	ZERO	7 500			
74720A	DEFAULT	1	9	Climb	MaxClimb	ZERO	10 000			
74720A	DEFAULT	2	1	Takeoff	MaxTakeoff	10				
74720A	DEFAULT	2	2	Climb	MaxTakeoff	10	1 000			
74720A	DEFAULT	2	3	Accelerate	MaxTakeoff	10		1 950	179	
74720A	DEFAULT	2	4	Accelerate	MaxClimb	5		1 000	242	
74720A	DEFAULT	2	5	Climb	MaxClimb	ZERO	3 000			
74720A	DEFAULT	2	6	Accelerate	MaxClimb	ZERO		1 000	262	
74720A	DEFAULT	2	7	Climb	MaxClimb	ZERO	5 500			
74720A	DEFAULT	2	8	Climb	MaxClimb	ZERO	7 500			
74720A	DEFAULT	2	9	Climb	MaxClimb	ZERO	10 000			
74720A	DEFAULT	3	1	Takeoff	MaxTakeoff	10				
74720A	DEFAULT	3	2	Climb	MaxTakeoff	10	1 000			
74720A	DEFAULT	3	3	Accelerate	MaxTakeoff	10		1 862	182	
74720A	DEFAULT	3	4	Accelerate	MaxClimb	5		1 000	244	

ACFTID	Profile_ID	Stage Length	Step Number	Step Type	Thrust Rating	Flap_ID	End Point Altitude (ft)	Rate Of Climb (ft/min)	End Point CAS (kt)	Accelerate_Percent (%)
74720A	DEFAULT	3	5	Climb	MaxClimb	ZERO	3 000			
74720A	DEFAULT	3	6	Accelerate	MaxClimb	ZERO		1 000	264	
74720A	DEFAULT	3	7	Climb	MaxClimb	ZERO	5 500			
74720A	DEFAULT	3	8	Climb	MaxClimb	ZERO	7 500			
74720A	DEFAULT	3	9	Climb	MaxClimb	ZERO	10 000			
74720A	DEFAULT	4	1	Takeoff	MaxTakeoff	10				
74720A	DEFAULT	4	2	Climb	MaxTakeoff	10	1 000			
74720A	DEFAULT	4	3	Accelerate	MaxTakeoff	10		1 700	188	
74720A	DEFAULT	4	4	Accelerate	MaxClimb	5		750	248	
74720A	DEFAULT	4	5	Climb	MaxClimb	ZERO	3 000			
74720A	DEFAULT	4	6	Accelerate	MaxClimb	ZERO		750	268	
74720A	DEFAULT	4	7	Climb	MaxClimb	ZERO	5 500			
74720A	DEFAULT	4	8	Climb	MaxClimb	ZERO	7 500			
74720A	DEFAULT	4	9	Climb	MaxClimb	ZERO	10 000			
74720A	DEFAULT	5	1	Takeoff	MaxTakeoff	10				
74720A	DEFAULT	5	2	Climb	MaxTakeoff	10	1 000			
74720A	DEFAULT	5	3	Accelerate	MaxTakeoff	10		1 520	195	
74720A	DEFAULT	5	4	Accelerate	MaxClimb	5		750	254	
74720A	DEFAULT	5	5	Climb	MaxClimb	ZERO	3 000			
74720A	DEFAULT	5	6	Accelerate	MaxClimb	ZERO		750	274	

ACFTID	Profile_ID	Stage Length	Step Number	Step Type	Thrust Rating	Flap_ID	End Point Altitude (ft)	Rate Of Climb (ft/min)	End Point CAS (kt)	Accelerate_Percent (%)
74720A	DEFAULT	5	7	Climb	MaxClimb	ZERO	5 500			
74720A	DEFAULT	5	8	Climb	MaxClimb	ZERO	7 500			
74720A	DEFAULT	5	9	Climb	MaxClimb	ZERO	10 000			
74720A	DEFAULT	6	1	Takeoff	MaxTakeoff	10				
74720A	DEFAULT	6	2	Climb	MaxTakeoff	10	1 000			
74720A	DEFAULT	6	3	Accelerate	MaxTakeoff	10		1 313	204	
74720A	DEFAULT	6	4	Accelerate	MaxClimb	5		750	264	
74720A	DEFAULT	6	5	Accelerate	MaxClimb	ZERO		750	284	
74720A	DEFAULT	6	6	Climb	MaxClimb	ZERO	5 500			
74720A	DEFAULT	6	7	Climb	MaxClimb	ZERO	7 500			
74720A	DEFAULT	6	8	Climb	MaxClimb	ZERO	10 000			
74720A	DEFAULT	7	1	Takeoff	MaxTakeoff	10				
74720A	DEFAULT	7	2	Climb	MaxTakeoff	10	1 000			
74720A	DEFAULT	7	3	Accelerate	MaxTakeoff	10		1 172	210	
74720A	DEFAULT	7	4	Accelerate	MaxClimb	5		750	272	
74720A	DEFAULT	7	5	Accelerate	MaxClimb	ZERO		750	292	
74720A	DEFAULT	7	6	Climb	MaxClimb	ZERO	5 500			
74720A	DEFAULT	7	7	Climb	MaxClimb	ZERO	7 500			
74720A	DEFAULT	7	8	Climb	MaxClimb	ZERO	10 000			
74720B	DEFAULT	1	1	Takeoff	MaxTakeoff	10				

ACFTID	Profile_ID	Stage Length	Step Number	Step Type	Thrust Rating	Flap_ID	End Point Altitude (ft)	Rate Of Climb (ft/min)	End Point CAS (kt)	Accelerate_Percent (%)
74720B	DEFAULT	1	2	Climb	MaxTakeoff	10	1 000			
74720B	DEFAULT	1	3	Accelerate	MaxTakeoff	10		2 497	184	
74720B	DEFAULT	1	4	Accelerate	MaxClimb	5		1 000	244	
74720B	DEFAULT	1	5	Climb	MaxClimb	ZERO	3 000			
74720B	DEFAULT	1	6	Accelerate	MaxClimb	ZERO		1 000	264	
74720B	DEFAULT	1	7	Climb	MaxClimb	ZERO	5 500			
74720B	DEFAULT	1	8	Climb	MaxClimb	ZERO	7 500			
74720B	DEFAULT	1	9	Climb	MaxClimb	ZERO	10 000			
74720B	DEFAULT	2	1	Takeoff	MaxTakeoff	10				
74720B	DEFAULT	2	2	Climb	MaxTakeoff	10	1 000			
74720B	DEFAULT	2	3	Accelerate	MaxTakeoff	10		2 397	187	
74720B	DEFAULT	2	4	Accelerate	MaxClimb	5		1 000	246	
74720B	DEFAULT	2	5	Climb	MaxClimb	ZERO	3 000			
74720B	DEFAULT	2	6	Accelerate	MaxClimb	ZERO		1 000	266	
74720B	DEFAULT	2	7	Climb	MaxClimb	ZERO	5 500			
74720B	DEFAULT	2	8	Climb	MaxClimb	ZERO	7 500			
74720B	DEFAULT	2	9	Climb	MaxClimb	ZERO	10 000			
74720B	DEFAULT	3	1	Takeoff	MaxTakeoff	10				
74720B	DEFAULT	3	2	Climb	MaxTakeoff	10	1 000			
74720B	DEFAULT	3	3	Accelerate	MaxTakeoff	10		2 303	190	

ACFTID	Profile_ID	Stage Length	Step Number	Step Type	Thrust Rating	Flap_ID	End Point Altitude (ft)	Rate Of Climb (ft/min)	End Point CAS (kt)	Accelerate_Percent (%)
74720B	DEFAULT	3	4	Accelerate	MaxClimb	5		750	249	
74720B	DEFAULT	3	5	Climb	MaxClimb	ZERO	3 000			
74720B	DEFAULT	3	6	Accelerate	MaxClimb	ZERO		750	269	
74720B	DEFAULT	3	7	Climb	MaxClimb	ZERO	5 500			
74720B	DEFAULT	3	8	Climb	MaxClimb	ZERO	7 500			
74720B	DEFAULT	3	9	Climb	MaxClimb	ZERO	10 000			
74720B	DEFAULT	4	1	Takeoff	MaxTakeoff	10				
74720B	DEFAULT	4	2	Climb	MaxTakeoff	10	1 000			
74720B	DEFAULT	4	3	Accelerate	MaxTakeoff	10		2 109	196	
74720B	DEFAULT	4	4	Accelerate	MaxClimb	5		750	254	
74720B	DEFAULT	4	5	Climb	MaxClimb	ZERO	3 000			
74720B	DEFAULT	4	6	Accelerate	MaxClimb	ZERO		750	274	
74720B	DEFAULT	4	7	Climb	MaxClimb	ZERO	5 500			
74720B	DEFAULT	4	8	Climb	MaxClimb	ZERO	7 500			
74720B	DEFAULT	4	9	Climb	MaxClimb	ZERO	10 000			
74720B	DEFAULT	5	1	Takeoff	MaxTakeoff	10				
74720B	DEFAULT	5	2	Climb	MaxTakeoff	10	1 000			
74720B	DEFAULT	5	3	Accelerate	MaxTakeoff	10		1 900	204	
74720B	DEFAULT	5	4	Accelerate	MaxClimb	5		750	263	
74720B	DEFAULT	5	5	Climb	MaxClimb	ZERO	3 000			

ACFTID	Profile_ID	Stage Length	Step Number	Step Type	Thrust Rating	Flap_ID	End Point Altitude (ft)	Rate Of Climb (ft/min)	End Point CAS (kt)	Accelerate_Percent (%)
74720B	DEFAULT	5	6	Accelerate	MaxClimb	ZERO		750	283	
74720B	DEFAULT	5	7	Climb	MaxClimb	ZERO	5 500			
74720B	DEFAULT	5	8	Climb	MaxClimb	ZERO	7 500			
74720B	DEFAULT	5	9	Climb	MaxClimb	ZERO	10 000			
74720B	DEFAULT	6	1	Takeoff	MaxTakeoff	10				
74720B	DEFAULT	6	2	Climb	MaxTakeoff	10	1 000			
74720B	DEFAULT	6	3	Accelerate	MaxTakeoff	10		1 699	211	
74720B	DEFAULT	6	4	Accelerate	MaxClimb	5		750	272	
74720B	DEFAULT	6	5	Climb	MaxClimb	ZERO	3 000			
74720B	DEFAULT	6	6	Accelerate	MaxClimb	ZERO		750	292	
74720B	DEFAULT	6	7	Climb	MaxClimb	ZERO	5 500			
74720B	DEFAULT	6	8	Climb	MaxClimb	ZERO	7 500			
74720B	DEFAULT	6	9	Climb	MaxClimb	ZERO	10 000			
74720B	DEFAULT	7	1	Takeoff	MaxTakeoff	10				
74720B	DEFAULT	7	2	Climb	MaxTakeoff	10	1 000			
74720B	DEFAULT	7	3	Accelerate	MaxTakeoff	10		1 547	218	
74720B	DEFAULT	7	4	Accelerate	MaxClimb	5		750	279	
74720B	DEFAULT	7	5	Accelerate	MaxClimb	ZERO		750	299	
74720B	DEFAULT	7	6	Climb	MaxClimb	ZERO	5 500			
74720B	DEFAULT	7	7	Climb	MaxClimb	ZERO	7 500			

ACFTID	Profile_ID	Stage Length	Step Number	Step Type	Thrust Rating	Flap_ID	End Point Altitude (ft)	Rate Of Climb (ft/min)	End Point CAS (kt)	Accelerate_Percent (%)
74720B	DEFAULT	7	8	Climb	MaxClimb	ZERO	10 000			
747400	DEFAULT	1	1	Takeoff	MaxTakeoff	10				
747400	DEFAULT	1	2	Climb	MaxTakeoff	T_10	1 000			
747400	DEFAULT	1	3	Accelerate	MaxClimb	10		1 533,3	190,8	
747400	DEFAULT	1	4	Accelerate	MaxClimb	T_05		1 798,9	242	
747400	DEFAULT	1	5	Climb	MaxClimb	5	3 869			
747400	DEFAULT	1	6	Accelerate	MaxClimb	ZERO		2 198,9	269	
747400	DEFAULT	1	7	Climb	MaxClimb	T_00H	5 500			
747400	DEFAULT	1	8	Climb	MaxClimb	T_00H	7 500			
747400	DEFAULT	1	9	Climb	MaxClimb	T_00H	10 000			
747400	DEFAULT	2	1	Takeoff	MaxTakeoff	10				
747400	DEFAULT	2	2	Climb	MaxTakeoff	T_10	1 000			
747400	DEFAULT	2	3	Accelerate	MaxClimb	10		1 507,6	192,9	
747400	DEFAULT	2	4	Accelerate	MaxClimb	T_05		1 718,8	244,6	
747400	DEFAULT	2	5	Climb	MaxClimb	T_01	3 756			
747400	DEFAULT	2	6	Accelerate	MaxClimb	T_00H		2 111,9	269	
747400	DEFAULT	2	7	Climb	MaxClimb	T_00H	5 500			
747400	DEFAULT	2	8	Climb	MaxClimb	T_00H	7 500			
747400	DEFAULT	2	9	Climb	MaxClimb	T_00H	10 000			
747400	DEFAULT	3	1	Takeoff	MaxTakeoff	10				

ACFTID	Profile_ID	Stage Length	Step Number	Step Type	Thrust Rating	Flap_ID	End Point Altitude (ft)	Rate Of Climb (ft/min)	End Point CAS (kt)	Accelerate_Percent (%)
747400	DEFAULT	3	2	Climb	MaxTakeoff	T_10	1 000			
747400	DEFAULT	3	3	Accelerate	MaxClimb	10		1 412,1	195,1	
747400	DEFAULT	3	4	Accelerate	MaxClimb	T_05		1 660,4	247,2	
747400	DEFAULT	3	5	Climb	MaxClimb	T_01	3 637			
747400	DEFAULT	3	6	Accelerate	MaxClimb	ZERO		2 033,6	269	
747400	DEFAULT	3	7	Climb	MaxClimb	T_00H	5 500			
747400	DEFAULT	3	8	Climb	MaxClimb	T_00H	7 500			
747400	DEFAULT	3	9	Climb	MaxClimb	T_00H	10 000			
747400	DEFAULT	4	1	Takeoff	MaxTakeoff	10				
747400	DEFAULT	4	2	Climb	MaxTakeoff	T_10	1 000			
747400	DEFAULT	4	3	Accelerate	MaxClimb	10		1 310,5	199,4	
747400	DEFAULT	4	4	Accelerate	MaxClimb	T_05		1 531,8	252,3	
747400	DEFAULT	4	5	Climb	MaxClimb	T_01	3 435			
747400	DEFAULT	4	6	Accelerate	MaxClimb	ZERO		1 882,8	269	
747400	DEFAULT	4	7	Climb	MaxClimb	T_00H	5 500			
747400	DEFAULT	4	8	Climb	MaxClimb	T_00H	7 500			
747400	DEFAULT	4	9	Climb	MaxClimb	T_00H	10 000			
747400	DEFAULT	5	1	Takeoff	MaxTakeoff	10				
747400	DEFAULT	5	2	Climb	MaxTakeoff	T_10	1 000			
747400	DEFAULT	5	3	Accelerate	MaxClimb	10		1 182,2	204,8	

ACFTID	Profile_ID	Stage Length	Step Number	Step Type	Thrust Rating	Flap_ID	End Point Altitude (ft)	Rate Of Climb (ft/min)	End Point CAS (kt)	Accelerate_Percent (%)
747400	DEFAULT	5	4	Accelerate	MaxClimb	T_05		1 402,6	258,4	
747400	DEFAULT	5	5	Climb	MaxClimb	T_01	3 199			
747400	DEFAULT	5	6	Accelerate	MaxClimb	ZERO		1 724,1	269	
747400	DEFAULT	5	7	Climb	MaxClimb	T_00H	5 500			
747400	DEFAULT	5	8	Climb	MaxClimb	T_00H	7 500			
747400	DEFAULT	5	9	Climb	MaxClimb	ZERO	10 000			
747400	DEFAULT	6	1	Takeoff	MaxTakeoff	10				
747400	DEFAULT	6	2	Climb	MaxTakeoff	T_10	1 000			
747400	DEFAULT	6	3	Accelerate	MaxClimb	5		1 088,1	210,4	
747400	DEFAULT	6	4	Accelerate	MaxClimb	5		1 372	259,5	
747400	DEFAULT	6	5	Accelerate	MaxClimb	T_01		1 432,4	264,7	
747400	DEFAULT	6	6	Climb	MaxClimb	T_01	3 004			
747400	DEFAULT	6	7	Accelerate	MaxClimb	ZERO		1 560	269	
747400	DEFAULT	6	8	Climb	MaxClimb	T_00H	5 500			
747400	DEFAULT	6	9	Climb	MaxClimb	T_00H	7 500			
747400	DEFAULT	6	10	Climb	MaxClimb	T_00H	10 000			
747400	DEFAULT	7	1	Takeoff	MaxTakeoff	10				
747400	DEFAULT	7	2	Climb	MaxTakeoff	T_10H	1 000			
747400	DEFAULT	7	3	Accelerate	MaxClimb	10		963,6	216,4	
747400	DEFAULT	7	4	Accelerate	MaxClimb	5		1 114,2	259,6	

ACFTID	Profile_ID	Stage Length	Step Number	Step Type	Thrust Rating	Flap_ID	End Point Altitude (ft)	Rate Of Climb (ft/min)	End Point CAS (kt)	Accelerate_Percent (%)
747400	DEFAULT	7	5	Climb	MaxClimb	T_01	2 544			
747400	DEFAULT	7	6	Accelerate	MaxClimb	T_05		1 329,4	270	
747400	DEFAULT	7	7	Climb	MaxClimb	T_00H	5 500			
747400	DEFAULT	7	8	Climb	MaxClimb	T_00H	7 500			
747400	DEFAULT	7	9	Climb	MaxClimb	T_00H	10 000			
747400	DEFAULT	8	1	Takeoff	MaxTakeoff	10				
747400	DEFAULT	8	2	Climb	MaxTakeoff	T_10H	1 000			
747400	DEFAULT	8	3	Accelerate	MaxClimb	10		855,6	222,8	
747400	DEFAULT	8	4	Accelerate	MaxClimb	5		968,9	259,6	
747400	DEFAULT	8	5	Climb	MaxClimb	T_01	2 561			
747400	DEFAULT	8	6	Accelerate	MaxClimb	T_01		1 173,1	270	
747400	DEFAULT	8	7	Accelerate	MaxClimb	T_00H		1 260	278	
747400	DEFAULT	8	8	Climb	MaxClimb	T_00H	5 500			
747400	DEFAULT	8	9	Climb	MaxClimb	T_00H	7 500			
747400	DEFAULT	8	10	Climb	MaxClimb	T_00H	10 000			
747400	DEFAULT	9	1	Takeoff	MaxTakeoff	10				
747400	DEFAULT	9	2	Climb	MaxTakeoff	T_10H	1 000			
747400	DEFAULT	9	3	Accelerate	MaxClimb	10		783,8	226,8	
747400	DEFAULT	9	4	Accelerate	MaxClimb	5		884,5	259,6	
747400	DEFAULT	9	5	Climb	MaxClimb	T_01	2 600			

ACFTID	Profile_ID	Stage Length	Step Number	Step Type	Thrust Rating	Flap_ID	End Point Altitude (ft)	Rate Of Climb (ft/min)	End Point CAS (kt)	Accelerate_Percent (%)
747400	DEFAULT	9	6	Accelerate	MaxClimb	T_01		1 078,7	271,8	
747400	DEFAULT	9	7	Accelerate	MaxClimb	T_00H		1 182,6	282,7	
747400	DEFAULT	9	8	Climb	MaxClimb	T_00H	5 500			
747400	DEFAULT	9	9	Climb	MaxClimb	T_00H	7 500			
747400	DEFAULT	9	10	Climb	MaxClimb	T_00H	10 000			
747400	ICAO_A	1	1	Takeoff	MaxTakeoff	10				
747400	ICAO_A	1	2	Climb	MaxTakeoff	T_10	1 500			
747400	ICAO_A	1	3	Climb	MaxClimb	10	3 000			
747400	ICAO_A	1	4	Accelerate	MaxClimb	10		1 472,8	190	
747400	ICAO_A	1	5	Accelerate	MaxClimb	5		1 753,3	241,7	
747400	ICAO_A	1	6	Climb	MaxClimb	T_01	5 796			
747400	ICAO_A	1	7	Accelerate	MaxClimb	ZERO		2 158,4	268,4	
747400	ICAO_A	1	8	Climb	MaxClimb	ZERO	7 500			
747400	ICAO_A	1	9	Climb	MaxClimb	ZERO	10 000			
747400	ICAO_A	2	1	Takeoff	MaxTakeoff	10				
747400	ICAO_A	2	2	Climb	MaxTakeoff	T_10	1 500			
747400	ICAO_A	2	3	Climb	MaxClimb	10	3 000			
747400	ICAO_A	2	4	Accelerate	MaxClimb	10		1 412,8	192,2	
747400	ICAO_A	2	5	Accelerate	MaxClimb	5		1 689,5	244,3	
747400	ICAO_A	2	6	Climb	MaxClimb	T_01	5 685			

ACFTID	Profile_ID	Stage Length	Step Number	Step Type	Thrust Rating	Flap_ID	End Point Altitude (ft)	Rate Of Climb (ft/min)	End Point CAS (kt)	Accelerate_Percent (%)
747400	ICAO_A	2	7	Accelerate	MaxClimb	ZERO		2 078,8	268,4	
747400	ICAO_A	2	8	Climb	MaxClimb	ZERO	7 500			
747400	ICAO_A	2	9	Climb	MaxClimb	ZERO	10 000			
747400	ICAO_A	3	1	Takeoff	MaxTakeoff	10				
747400	ICAO_A	3	2	Climb	MaxTakeoff	T_10	1 500			
747400	ICAO_A	3	3	Climb	MaxClimb	10	3 000			
747400	ICAO_A	3	4	Accelerate	MaxClimb	10		1 353,5	194,4	
747400	ICAO_A	3	5	Accelerate	MaxClimb	5		1 618,4	246,8	
747400	ICAO_A	3	6	Climb	MaxClimb	T_01	5 579			
747400	ICAO_A	3	7	Accelerate	MaxClimb	ZERO		1 995	268,4	
747400	ICAO_A	3	8	Climb	MaxClimb	ZERO	7 500			
747400	ICAO_A	3	9	Climb	MaxClimb	ZERO	10 000			
747400	ICAO_A	4	1	Takeoff	MaxTakeoff	10				
747400	ICAO_A	4	2	Climb	MaxTakeoff	T_10	1 500			
747400	ICAO_A	4	3	Climb	MaxClimb	10	3 000			
747400	ICAO_A	4	4	Accelerate	MaxClimb	10		1 249,3	198,7	
747400	ICAO_A	4	5	Accelerate	MaxClimb	5		1 500,4	251,9	
747400	ICAO_A	4	6	Climb	MaxClimb	T_01	5 372			
747400	ICAO_A	4	7	Accelerate	MaxClimb	ZERO		1 847,9	268,4	
747400	ICAO_A	4	8	Climb	MaxClimb	ZERO	7 500			

ACFTID	Profile_ID	Stage Length	Step Number	Step Type	Thrust Rating	Flap_ID	End Point Altitude (ft)	Rate Of Climb (ft/min)	End Point CAS (kt)	Accelerate_Percent (%)
747400	ICAO_A	4	9	Climb	MaxClimb	ZERO	10 000			
747400	ICAO_A	5	1	Takeoff	MaxTakeoff	10				
747400	ICAO_A	5	2	Climb	MaxTakeoff	T_10	1 500			
747400	ICAO_A	5	3	Climb	MaxClimb	10	3 000			
747400	ICAO_A	5	4	Accelerate	MaxClimb	10		1 131,2	204,1	
747400	ICAO_A	5	5	Accelerate	MaxClimb	5		1 367,5	257,8	
747400	ICAO_A	5	6	Climb	MaxClimb	T_01	5 145			
747400	ICAO_A	5	7	Accelerate	MaxClimb	ZERO		1 686,7	268,4	
747400	ICAO_A	5	8	Climb	MaxClimb	ZERO	7 500			
747400	ICAO_A	5	9	Climb	MaxClimb	ZERO	10 000			
747400	ICAO_A	6	1	Takeoff	MaxTakeoff	10				
747400	ICAO_A	6	2	Climb	MaxTakeoff	T_10H	1 500			
747400	ICAO_A	6	3	Climb	MaxClimb	10	3 000			
747400	ICAO_A	6	4	Accelerate	MaxClimb	10		1 017,7	209,8	
747400	ICAO_A	6	5	Accelerate	MaxClimb	5		1 223,8	259,1	
747400	ICAO_A	6	6	Climb	MaxClimb	T_01	4 508			
747400	ICAO_A	6	7	Accelerate	MaxClimb	T_01		1 416	264,3	
747400	ICAO_A	6	8	Climb	MaxClimb	ZERO	4 921			
747400	ICAO_A	6	9	Accelerate	MaxClimb	ZERO		1 531	269	
747400	ICAO_A	6	10	Climb	MaxClimb	ZERO	5 500			

ACFTID	Profile_ID	Stage Length	Step Number	Step Type	Thrust Rating	Flap_ID	End Point Altitude (ft)	Rate Of Climb (ft/min)	End Point CAS (kt)	Accelerate_Percent (%)
747400	ICAO_A	6	11	Climb	MaxClimb	ZERO	7 500			
747400	ICAO_A	6	12	Climb	MaxClimb	ZERO	10 000			
747400	ICAO_A	7	1	Takeoff	MaxTakeoff	10				
747400	ICAO_A	7	2	Climb	MaxTakeoff	T_10H	1 500			
747400	ICAO_A	7	3	Climb	MaxClimb	10	3 000			
747400	ICAO_A	7	4	Accelerate	MaxClimb	10		908,3	215,8	
747400	ICAO_A	7	5	Accelerate	MaxClimb	5		1 082,4	259,1	
747400	ICAO_A	7	6	Climb	MaxClimb	T_01	4 509			
747400	ICAO_A	7	7	Accelerate	MaxClimb	T_01		1 308,4	269,1	
747400	ICAO_A	7	8	Accelerate	MaxClimb	ZERO		1 365,5	271	
747400	ICAO_A	7	9	Climb	MaxClimb	ZERO	5 500			
747400	ICAO_A	7	10	Climb	MaxClimb	ZERO	7 500			
747400	ICAO_A	7	11	Climb	MaxClimb	T_00H	10 000			
747400	ICAO_A	8	1	Takeoff	MaxTakeoff	10				
747400	ICAO_A	8	2	Climb	MaxTakeoff	T_10H	1 500			
747400	ICAO_A	8	3	Climb	MaxClimb	10	3 000			
747400	ICAO_A	8	4	Accelerate	MaxClimb	10		801,1	222,2	
747400	ICAO_A	8	5	Accelerate	MaxClimb	5		942,7	259,1	
747400	ICAO_A	8	6	Climb	MaxClimb	T_01	4 540			
747400	ICAO_A	8	7	Accelerate	MaxClimb	T_01		1 146,3	267,9	

ACFTID	Profile_ID	Stage Length	Step Number	Step Type	Thrust Rating	Flap_ID	End Point Altitude (ft)	Rate Of Climb (ft/min)	End Point CAS (kt)	Accelerate_Percent (%)
747400	ICAO_A	8	8	Accelerate	MaxClimb	ZERO		1 230	277,7	
747400	ICAO_A	8	9	Climb	MaxClimb	ZERO	5 500			
747400	ICAO_A	8	10	Climb	MaxClimb	T_00H	7 500			
747400	ICAO_A	8	11	Climb	MaxClimb	T_00H	10 000			
747400	ICAO_A	9	1	Takeoff	MaxTakeoff	10				
747400	ICAO_A	9	2	Climb	MaxTakeoff	T_10H	1 500			
747400	ICAO_A	9	3	Climb	MaxClimb	10	3 000			
747400	ICAO_A	9	4	Accelerate	MaxClimb	10		734,4	226,3	
747400	ICAO_A	9	5	Accelerate	MaxClimb	5		858,9	259,1	
747400	ICAO_A	9	6	Climb	MaxClimb	T_01	4 590			
747400	ICAO_A	9	7	Accelerate	MaxClimb	T_01		1 051,2	270,6	
747400	ICAO_A	9	8	Accelerate	MaxClimb	T_00H		1 143	282,2	
747400	ICAO_A	9	9	Climb	MaxClimb	T_00H	5 500			
747400	ICAO_A	9	10	Climb	MaxClimb	T_00H	7 500			
747400	ICAO_A	9	11	Climb	MaxClimb	T_00H	10 000			
747400	ICAO_B	1	1	Takeoff	MaxTakeoff	10				
747400	ICAO_B	1	2	Climb	MaxTakeoff	T_10	1 000			
747400	ICAO_B	1	3	Accelerate	MaxTakeoff	10		1 890,2	182,3	
747400	ICAO_B	1	4	Climb	MaxTakeoff	10	1 646			
747400	ICAO_B	1	5	Accelerate	MaxClimb	T_05		1 788,2	242	

ACFTID	Profile_ID	Stage Length	Step Number	Step Type	Thrust Rating	Flap_ID	End Point Altitude (ft)	Rate Of Climb (ft/min)	End Point CAS (kt)	Accelerate_Percent (%)
747400	ICAO_B	1	6	Climb	MaxClimb	T_05	4 194			
747400	ICAO_B	1	7	Accelerate	MaxClimb	ZERO		2 170,6	259	
747400	ICAO_B	1	8	Climb	MaxClimb	ZERO	5 500			
747400	ICAO_B	1	9	Climb	MaxClimb	ZERO	7 500			
747400	ICAO_B	1	10	Climb	MaxClimb	ZERO	10 000			
747400	ICAO_B	2	1	Takeoff	MaxTakeoff	10				
747400	ICAO_B	2	2	Climb	MaxTakeoff	T_10	1 000			
747400	ICAO_B	2	3	Accelerate	MaxTakeoff	10		1 836,7	184,9	
747400	ICAO_B	2	4	Climb	MaxTakeoff	10	1 640			
747400	ICAO_B	2	5	Accelerate	MaxClimb	T_05		1 727,1	244,6	
747400	ICAO_B	2	6	Climb	MaxClimb	T_05	4 067			
747400	ICAO_B	2	7	Accelerate	MaxClimb	ZERO		2 088,1	259,2	
747400	ICAO_B	2	8	Climb	MaxClimb	ZERO	5 500			
747400	ICAO_B	2	9	Climb	MaxClimb	ZERO	7 500			
747400	ICAO_B	2	10	Climb	MaxClimb	ZERO	10 000			
747400	ICAO_B	3	1	Takeoff	MaxTakeoff	10				
747400	ICAO_B	3	2	Climb	MaxTakeoff	T_10	1 000			
747400	ICAO_B	3	3	Accelerate	MaxTakeoff	10		1 777,6	187,5	
747400	ICAO_B	3	4	Climb	MaxTakeoff	10	1 637			
747400	ICAO_B	3	5	Accelerate	MaxClimb	T_05		1 653,3	247,2	

ACFTID	Profile_ID	Stage Length	Step Number	Step Type	Thrust Rating	Flap_ID	End Point Altitude (ft)	Rate Of Climb (ft/min)	End Point CAS (kt)	Accelerate_Percent (%)
747400	ICAO_B	3	6	Climb	MaxClimb	T_05C	3 942			
747400	ICAO_B	3	7	Accelerate	MaxClimb	ZERO		2 009,7	259,2	
747400	ICAO_B	3	8	Climb	MaxClimb	ZERO	5 500			
747400	ICAO_B	3	9	Climb	MaxClimb	ZERO	7 500			
747400	ICAO_B	3	10	Climb	MaxClimb	ZERO	10 000			
747400	ICAO_B	4	1	Takeoff	MaxTakeoff	10				
747400	ICAO_B	4	2	Climb	MaxTakeoff	T_10	1 000			
747400	ICAO_B	4	3	Accelerate	MaxTakeoff	10		1 653,5	192,6	
747400	ICAO_B	4	4	Climb	MaxTakeoff	10	1 633			
747400	ICAO_B	4	5	Accelerate	MaxClimb	T_05		1 535,2	252,2	
747400	ICAO_B	4	6	Climb	MaxClimb	T_05C	3 718			
747400	ICAO_B	4	7	Accelerate	MaxClimb	ZERO		1 858,5	259,2	
747400	ICAO_B	4	8	Climb	MaxClimb	ZERO	5 500			
747400	ICAO_B	4	9	Climb	MaxClimb	ZERO	7 500			
747400	ICAO_B	4	10	Climb	MaxClimb	ZERO	10 000			
747400	ICAO_B	5	1	Takeoff	MaxTakeoff	10				
747400	ICAO_B	5	2	Climb	MaxTakeoff	T_10	1 000			
747400	ICAO_B	5	3	Accelerate	MaxTakeoff	10		1 518,3	198,7	
747400	ICAO_B	5	4	Climb	MaxTakeoff	10	1 619			
747400	ICAO_B	5	5	Accelerate	MaxClimb	T_05		1 397,6	258,3	

ACFTID	Profile_ID	Stage Length	Step Number	Step Type	Thrust Rating	Flap_ID	End Point Altitude (ft)	Rate Of Climb (ft/min)	End Point CAS (kt)	Accelerate_Percent (%)
747400	ICAO_B	5	6	Climb	MaxClimb	T_05C	3 459			
747400	ICAO_B	5	7	Accelerate	MaxClimb	ZERO		1 685,4	259,4	
747400	ICAO_B	5	8	Climb	MaxClimb	ZERO	5 500			
747400	ICAO_B	5	9	Climb	MaxClimb	ZERO	7 500			
747400	ICAO_B	5	10	Climb	MaxClimb	ZERO	10 000			
747400	ICAO_B	6	1	Takeoff	MaxTakeoff	10				
747400	ICAO_B	6	2	Climb	MaxTakeoff	T_10	1 000			
747400	ICAO_B	6	3	Accelerate	MaxTakeoff	10		1 394,6	205,1	
747400	ICAO_B	6	4	Climb	MaxTakeoff	T_05C	1 606			
747400	ICAO_B	6	5	Accelerate	MaxClimb	T_05		1 346,5	264,7	
747400	ICAO_B	6	6	Climb	MaxClimb	T_05C	3 217			
747400	ICAO_B	6	7	Accelerate	MaxClimb	ZERO		1 560	269,2	
747400	ICAO_B	6	8	Climb	MaxClimb	ZERO	5 500			
747400	ICAO_B	6	9	Climb	MaxClimb	ZERO	7 500			
747400	ICAO_B	6	10	Climb	MaxClimb	ZERO	10 000			
747400	ICAO_B	7	1	Takeoff	MaxTakeoff	10				
747400	ICAO_B	7	2	Climb	MaxTakeoff	T_10H	1 000			
747400	ICAO_B	7	3	Accelerate	MaxTakeoff	10		1 271	211,9	
747400	ICAO_B	7	4	Climb	MaxTakeoff	T_05	1 597			
747400	ICAO_B	7	5	Accelerate	MaxClimb	T_05		1 112,4	259,4	

ACFTID	Profile_ID	Stage Length	Step Number	Step Type	Thrust Rating	Flap_ID	End Point Altitude (ft)	Rate Of Climb (ft/min)	End Point CAS (kt)	Accelerate_Percent (%)
747400	ICAO_B	7	6	Climb	MaxClimb	T_05C	2 759			
747400	ICAO_B	7	7	Accelerate	MaxClimb	T_01		1 323,5	271,4	
747400	ICAO_B	7	8	Climb	MaxClimb	ZERO	5 500			
747400	ICAO_B	7	9	Climb	MaxClimb	T_00H	7 500			
747400	ICAO_B	7	10	Climb	MaxClimb	T_00H	10 000			
747400	ICAO_B	8	1	Takeoff	MaxTakeoff	10				
747400	ICAO_B	8	2	Climb	MaxTakeoff	T_10H	1 000			
747400	ICAO_B	8	3	Accelerate	MaxTakeoff	10		1 147	218,9	
747400	ICAO_B	8	4	Climb	MaxTakeoff	T_05	1 592			
747400	ICAO_B	8	5	Accelerate	MaxClimb	T_05		975,2	259,6	
747400	ICAO_B	8	6	Climb	MaxClimb	T_05C	2 755			
747400	ICAO_B	8	7	Accelerate	MaxClimb	T_01		1 209,5	278,4	
747400	ICAO_B	8	8	Climb	MaxClimb	T_00H	5 500			
747400	ICAO_B	8	9	Climb	MaxClimb	T_00H	7 500			
747400	ICAO_B	8	10	Climb	MaxClimb	T_00H	10 000			
747400	ICAO_B	9	1	Takeoff	MaxTakeoff	10				
747400	ICAO_B	9	2	Climb	MaxTakeoff	T_10H	1 000			
747400	ICAO_B	9	3	Accelerate	MaxTakeoff	10		1 070,9	223,3	
747400	ICAO_B	9	4	Climb	MaxTakeoff	10	1 611			
747400	ICAO_B	9	5	Accelerate	MaxClimb	T_05		893,7	259,5	

ACFTID	Profile_ID	Stage Length	Step Number	Step Type	Thrust Rating	Flap_ID	End Point Altitude (ft)	Rate Of Climb (ft/min)	End Point CAS (kt)	Accelerate_Percent (%)
747400	ICAO_B	9	6	Climb	MaxClimb	T_01	2 782			
747400	ICAO_B	9	7	Accelerate	MaxClimb	T_01		1 119,3	282,7	
747400	ICAO_B	9	8	Climb	MaxClimb	T_00H	5 500			
747400	ICAO_B	9	9	Climb	MaxClimb	T_00H	7 500			
747400	ICAO_B	9	10	Climb	MaxClimb	T_00H	10 000			
7478	DEFAULT	1	1	Takeoff	MaxTakeoff	F_10				
7478	DEFAULT	1	2	Climb	MaxTakeoff	F_10	1 000			
7478	DEFAULT	1	3	Accelerate_Percent	MaxClimb	F_10			215	55
7478	DEFAULT	1	4	Accelerate_Percent	MaxClimb	F_5			250	55
7478	DEFAULT	1	5	Accelerate_Percent	MaxClimb	F_1			260	55
7478	DEFAULT	1	6	Climb	MaxClimb	F_0	3 000			
7478	DEFAULT	1	7	Accelerate_Percent	MaxClimb	F_0			295	50
7478	DEFAULT	1	8	Climb	MaxClimb	F_0	10 000			
7478	DEFAULT	2	1	Takeoff	MaxTakeoff	F_10				
7478	DEFAULT	2	2	Climb	MaxTakeoff	F_10	1 000			
7478	DEFAULT	2	3	Accelerate_Percent	MaxClimb	F_10			215	55
7478	DEFAULT	2	4	Accelerate_Percent	MaxClimb	F_5			250	55
7478	DEFAULT	2	5	Accelerate_Percent	MaxClimb	F_1			260	55
7478	DEFAULT	2	6	Climb	MaxClimb	F_0	3 000			
7478	DEFAULT	2	7	Accelerate_Percent	MaxClimb	F_0			295	50

ACFTID	Profile_ID	Stage Length	Step Number	Step Type	Thrust Rating	Flap_ID	End Point Altitude (ft)	Rate Of Climb (ft/min)	End Point CAS (kt)	Accelerate_Percent (%)
7478	DEFAULT	2	8	Climb	MaxClimb	F_0	10 000			
7478	DEFAULT	3	1	Takeoff	MaxTakeoff	F_10				
7478	DEFAULT	3	2	Climb	MaxTakeoff	F_10	1 000			
7478	DEFAULT	3	3	Accelerate_Percent	MaxClimb	F_10			215	55
7478	DEFAULT	3	4	Accelerate_Percent	MaxClimb	F_5			250	55
7478	DEFAULT	3	5	Accelerate_Percent	MaxClimb	F_1			260	55
7478	DEFAULT	3	6	Climb	MaxClimb	F_0	3 000			
7478	DEFAULT	3	7	Accelerate_Percent	MaxClimb	F_0			295	50
7478	DEFAULT	3	8	Climb	MaxClimb	F_0	10 000			
7478	DEFAULT	4	1	Takeoff	MaxTakeoff	F_10				
7478	DEFAULT	4	2	Climb	MaxTakeoff	F_10	1 000			
7478	DEFAULT	4	3	Accelerate_Percent	MaxClimb	F_10			220	55
7478	DEFAULT	4	4	Accelerate_Percent	MaxClimb	F_5			250	55
7478	DEFAULT	4	5	Accelerate_Percent	MaxClimb	F_1			268	55
7478	DEFAULT	4	6	Climb	MaxClimb	F_0	3 000			
7478	DEFAULT	4	7	Accelerate_Percent	MaxClimb	F_0			295	50
7478	DEFAULT	4	8	Climb	MaxClimb	F_0	10 000			
7478	DEFAULT	5	1	Takeoff	MaxTakeoff	F_10				
7478	DEFAULT	5	2	Climb	MaxTakeoff	F_10	1 000			
7478	DEFAULT	5	3	Accelerate_Percent	MaxClimb	F_10			220	55

ACFTID	Profile_ID	Stage Length	Step Number	Step Type	Thrust Rating	Flap_ID	End Point Altitude (ft)	Rate Of Climb (ft/min)	End Point CAS (kt)	Accelerate_Percent (%)
7478	DEFAULT	5	4	Accelerate_Percent	MaxClimb	F_5			250	55
7478	DEFAULT	5	5	Accelerate_Percent	MaxClimb	F_1			270	55
7478	DEFAULT	5	6	Climb	MaxClimb	F_0	3 000			
7478	DEFAULT	5	7	Accelerate_Percent	MaxClimb	F_0			295	50
7478	DEFAULT	5	8	Climb	MaxClimb	F_0	10 000			
7478	DEFAULT	6	1	Takeoff	MaxTakeoff	F_10				
7478	DEFAULT	6	2	Climb	MaxTakeoff	F_10	1 000			
7478	DEFAULT	6	3	Accelerate_Percent	MaxClimb	F_10			227	55
7478	DEFAULT	6	4	Accelerate_Percent	MaxClimb	F_5			258	55
7478	DEFAULT	6	5	Accelerate_Percent	MaxClimb	F_1			270	55
7478	DEFAULT	6	6	Climb	MaxClimb	F_0	3 000			
7478	DEFAULT	6	7	Accelerate_Percent	MaxClimb	F_0			295	50
7478	DEFAULT	6	8	Climb	MaxClimb	F_0	10 000			
7478	DEFAULT	7	1	Takeoff	MaxTakeoff	F_10				
7478	DEFAULT	7	2	Climb	MaxTakeoff	F_10	1 000			
7478	DEFAULT	7	3	Accelerate_Percent	MaxClimb	F_10			230	55
7478	DEFAULT	7	4	Accelerate_Percent	MaxClimb	F_5			260	55
7478	DEFAULT	7	5	Accelerate_Percent	MaxClimb	F_1			275	55
7478	DEFAULT	7	6	Climb	MaxClimb	F_0	3 000			
7478	DEFAULT	7	7	Accelerate_Percent	MaxClimb	F_0			295	50

ACFTID	Profile_ID	Stage Length	Step Number	Step Type	Thrust Rating	Flap_ID	End Point Altitude (ft)	Rate Of Climb (ft/min)	End Point CAS (kt)	Accelerate_Percent (%)
7478	DEFAULT	7	8	Climb	MaxClimb	F_0	10 000			
7478	DEFAULT	8	1	Takeoff	MaxTakeoff	F_10				
7478	DEFAULT	8	2	Climb	MaxTakeoff	F_10	1 000			
7478	DEFAULT	8	3	Accelerate_Percent	MaxClimb	F_10			235	55
7478	DEFAULT	8	4	Accelerate_Percent	MaxClimb	F_5			265	55
7478	DEFAULT	8	5	Accelerate_Percent	MaxClimb	F_1			280	55
7478	DEFAULT	8	6	Climb	MaxClimb	F_0	3 000			
7478	DEFAULT	8	7	Accelerate_Percent	MaxClimb	F_0			295	50
7478	DEFAULT	8	8	Climb	MaxClimb	F_0	10 000			
7478	DEFAULT	9	1	Takeoff	MaxTakeoff	F_10				
7478	DEFAULT	9	2	Climb	MaxTakeoff	F_10	1 000			
7478	DEFAULT	9	3	Accelerate_Percent	MaxClimb	F_10			235	55
7478	DEFAULT	9	4	Accelerate_Percent	MaxClimb	F_5			265	55
7478	DEFAULT	9	5	Accelerate_Percent	MaxClimb	F_1			280	55
7478	DEFAULT	9	6	Climb	MaxClimb	F_0	3 000			
7478	DEFAULT	9	7	Accelerate_Percent	MaxClimb	F_0			295	50
7478	DEFAULT	9	8	Climb	MaxClimb	F_0	10 000			
7478	ICAO_A	1	1	Takeoff	MaxTakeoff	F_10				
7478	ICAO_A	1	2	Climb	MaxTakeoff	F_10	1 500			
7478	ICAO_A	1	3	Climb	MaxClimb	F_10	3 000			

ACFTID	Profile_ID	Stage Length	Step Number	Step Type	Thrust Rating	Flap_ID	End Point Altitude (ft)	Rate Of Climb (ft/min)	End Point CAS (kt)	Accelerate_Percent (%)
7478	ICAO_A	1	4	Accelerate_Percent	MaxClimb	F_10			220	55
7478	ICAO_A	1	5	Accelerate_Percent	MaxClimb	F_5			250	55
7478	ICAO_A	1	6	Climb	MaxClimb	F_1	4 700			
7478	ICAO_A	1	7	Accelerate_Percent	MaxClimb	F_0			276	50
7478	ICAO_A	1	8	Climb	MaxClimb	F_0	10 000			
7478	ICAO_A	2	1	Takeoff	MaxTakeoff	F_10				
7478	ICAO_A	2	2	Climb	MaxTakeoff	F_10	1 500			
7478	ICAO_A	2	3	Climb	MaxClimb	F_10	3 000			
7478	ICAO_A	2	4	Accelerate_Percent	MaxClimb	F_10			220	55
7478	ICAO_A	2	5	Accelerate_Percent	MaxClimb	F_1			254	55
7478	ICAO_A	2	6	Climb	MaxClimb	F_1	4 800			
7478	ICAO_A	2	7	Accelerate_Percent	MaxClimb	F_0			275	50
7478	ICAO_A	2	8	Climb	MaxClimb	F_0	10 000			
7478	ICAO_A	3	1	Takeoff	MaxTakeoff	F_10				
7478	ICAO_A	3	2	Climb	MaxTakeoff	F_10	1 500			
7478	ICAO_A	3	3	Climb	MaxClimb	F_10	3 000			
7478	ICAO_A	3	4	Accelerate_Percent	MaxClimb	F_5			220	55
7478	ICAO_A	3	5	Accelerate_Percent	MaxClimb	F_1			255	55
7478	ICAO_A	3	6	Climb	MaxClimb	F_1	4 500			
7478	ICAO_A	3	7	Accelerate_Percent	MaxClimb	F_0			275	50

ACFTID	Profile_ID	Stage Length	Step Number	Step Type	Thrust Rating	Flap_ID	End Point Altitude (ft)	Rate Of Climb (ft/min)	End Point CAS (kt)	Accelerate_Percent (%)
7478	ICAO_A	3	8	Climb	MaxClimb	F_0	10 000			
7478	ICAO_A	4	1	Takeoff	MaxTakeoff	F_10				
7478	ICAO_A	4	2	Climb	MaxTakeoff	F_10	1 500			
7478	ICAO_A	4	3	Climb	MaxClimb	F_10	3 000			
7478	ICAO_A	4	4	Accelerate_Percent	MaxClimb	F_10			220	55
7478	ICAO_A	4	5	Accelerate_Percent	MaxClimb	F_5			255	55
7478	ICAO_A	4	6	Accelerate_Percent	MaxClimb	F_1			275	55
7478	ICAO_A	4	7	Climb	MaxClimb	F_0	10 000			
7478	ICAO_A	5	1	Takeoff	MaxTakeoff	F_10				
7478	ICAO_A	5	2	Climb	MaxTakeoff	F_10	1 500			
7478	ICAO_A	5	3	Climb	MaxClimb	F_10	3 000			
7478	ICAO_A	5	4	Accelerate_Percent	MaxClimb	F_5			220	55
7478	ICAO_A	5	5	Accelerate_Percent	MaxClimb	F_1			255	55
7478	ICAO_A	5	6	Accelerate_Percent	MaxClimb	F_0			275	50
7478	ICAO_A	5	7	Climb	MaxClimb	F_0	10 000			
7478	ICAO_A	6	1	Takeoff	MaxTakeoff	F_10				
7478	ICAO_A	6	2	Climb	MaxTakeoff	F_10	1 500			
7478	ICAO_A	6	3	Climb	MaxClimb	F_10	3 000			
7478	ICAO_A	6	4	Accelerate_Percent	MaxClimb	F_5			225	55
7478	ICAO_A	6	5	Accelerate_Percent	MaxClimb	F_1			255	55

ACFTID	Profile_ID	Stage Length	Step Number	Step Type	Thrust Rating	Flap_ID	End Point Altitude (ft)	Rate Of Climb (ft/min)	End Point CAS (kt)	Accelerate_Percent (%)
7478	ICAO_A	6	6	Accelerate_Percent	MaxClimb	F_0			278	50
7478	ICAO_A	6	7	Climb	MaxClimb	F_0	10 000			
7478	ICAO_A	7	1	Takeoff	MaxTakeoff	F_10				
7478	ICAO_A	7	2	Climb	MaxTakeoff	F_10	1 500			
7478	ICAO_A	7	3	Climb	MaxClimb	F_10	3 000			
7478	ICAO_A	7	4	Accelerate_Percent	MaxClimb	F_5			225	55
7478	ICAO_A	7	5	Accelerate_Percent	MaxClimb	F_1			255	55
7478	ICAO_A	7	6	Accelerate_Percent	MaxClimb	F_0			278	50
7478	ICAO_A	7	7	Climb	MaxClimb	F_0	10 000			
7478	ICAO_A	8	1	Takeoff	MaxTakeoff	F_10				
7478	ICAO_A	8	2	Climb	MaxTakeoff	F_10	1 500			
7478	ICAO_A	8	3	Climb	MaxClimb	F_10	3 000			
7478	ICAO_A	8	4	Accelerate_Percent	MaxClimb	F_5			230	55
7478	ICAO_A	8	5	Accelerate_Percent	MaxClimb	F_1			265	55
7478	ICAO_A	8	6	Accelerate_Percent	MaxClimb	F_0			280	50
7478	ICAO_A	8	7	Climb	MaxClimb	F_0	10 000			
7478	ICAO_A	9	1	Takeoff	MaxTakeoff	F_10				
7478	ICAO_A	9	2	Climb	MaxTakeoff	F_10	1 500			
7478	ICAO_A	9	3	Climb	MaxClimb	F_10	3 000			
7478	ICAO_A	9	4	Accelerate_Percent	MaxClimb	F_5			230	55

ACFTID	Profile_ID	Stage Length	Step Number	Step Type	Thrust Rating	Flap_ID	End Point Altitude (ft)	Rate Of Climb (ft/min)	End Point CAS (kt)	Accelerate_Percent (%)
7478	ICAO_A	9	5	Accelerate_Percent	MaxClimb	F_1			265	55
7478	ICAO_A	9	6	Accelerate_Percent	MaxClimb	F_0			280	50
7478	ICAO_A	9	7	Climb	MaxClimb	F_0	10 000			
7478	ICAO_B	1	1	Takeoff	MaxTakeoff	F_10				
7478	ICAO_B	1	2	Climb	MaxTakeoff	F_10	1 000			
7478	ICAO_B	1	3	Accelerate_Percent	MaxTakeoff	F_10			210	55
7478	ICAO_B	1	4	Accelerate_Percent	MaxTakeoff	F_5			250	55
7478	ICAO_B	1	5	Climb	MaxTakeoff	F_1	3 480			
7478	ICAO_B	1	6	Accelerate_Percent	MaxClimb	F_0			280	50
7478	ICAO_B	1	7	Climb	MaxClimb	F_0	10 000			
7478	ICAO_B	2	1	Takeoff	MaxTakeoff	F_10				
7478	ICAO_B	2	2	Climb	MaxTakeoff	F_10	1 000			
7478	ICAO_B	2	3	Accelerate_Percent	MaxTakeoff	F_10			223	55
7478	ICAO_B	2	4	Accelerate_Percent	MaxTakeoff	F_5			250	55
7478	ICAO_B	2	5	Climb	MaxTakeoff	F_1	3 350			
7478	ICAO_B	2	6	Accelerate_Percent	MaxClimb	F_0			280	50
7478	ICAO_B	2	7	Climb	MaxClimb	F_0	10 000			
7478	ICAO_B	3	1	Takeoff	MaxTakeoff	F_10				
7478	ICAO_B	3	2	Climb	MaxTakeoff	F_10	1 000			
7478	ICAO_B	3	3	Accelerate_Percent	MaxTakeoff	F_10			223	55

ACFTID	Profile_ID	Stage Length	Step Number	Step Type	Thrust Rating	Flap_ID	End Point Altitude (ft)	Rate Of Climb (ft/min)	End Point CAS (kt)	Accelerate_Percent (%)
7478	ICAO_B	3	4	Accelerate_Percent	MaxTakeoff	F_5			263	55
7478	ICAO_B	3	5	Climb	MaxTakeoff	F_1	3 350			
7478	ICAO_B	3	6	Accelerate_Percent	MaxClimb	F_0			300	50
7478	ICAO_B	3	7	Climb	MaxClimb	F_0	10 000			
7478	ICAO_B	4	1	Takeoff	MaxTakeoff	F_10				
7478	ICAO_B	4	2	Climb	MaxTakeoff	F_10	1 000			
7478	ICAO_B	4	3	Accelerate_Percent	MaxTakeoff	F_10			210	55
7478	ICAO_B	4	4	Accelerate_Percent	MaxTakeoff	F_5			260	55
7478	ICAO_B	4	5	Climb	MaxTakeoff	F_1	3 480			
7478	ICAO_B	4	6	Accelerate_Percent	MaxClimb	F_0			270	50
7478	ICAO_B	4	7	Climb	MaxClimb	F_0	10 000			
7478	ICAO_B	5	1	Takeoff	MaxTakeoff	F_10				
7478	ICAO_B	5	2	Climb	MaxTakeoff	F_10	1 000			
7478	ICAO_B	5	3	Accelerate_Percent	MaxTakeoff	F_10			228	55
7478	ICAO_B	5	4	Accelerate_Percent	MaxTakeoff	F_5			262	55
7478	ICAO_B	5	5	Climb	MaxTakeoff	F_1	2 760			
7478	ICAO_B	5	6	Accelerate_Percent	MaxClimb	F_0			270	50
7478	ICAO_B	5	7	Climb	MaxClimb	F_0	10 000			
7478	ICAO_B	6	1	Takeoff	MaxTakeoff	F_10				
7478	ICAO_B	6	2	Climb	MaxTakeoff	F_10	1 000			

ACFTID	Profile_ID	Stage Length	Step Number	Step Type	Thrust Rating	Flap_ID	End Point Altitude (ft)	Rate Of Climb (ft/min)	End Point CAS (kt)	Accelerate_Percent (%)
7478	ICAO_B	6	3	Accelerate_Percent	MaxTakeoff	F_10			231	55
7478	ICAO_B	6	4	Accelerate_Percent	MaxTakeoff	F_5			264	55
7478	ICAO_B	6	5	Climb	MaxTakeoff	F_1	2 610			
7478	ICAO_B	6	6	Accelerate_Percent	MaxClimb	F_0			300	50
7478	ICAO_B	6	7	Climb	MaxClimb	F_0	10 000			
7478	ICAO_B	7	1	Takeoff	MaxTakeoff	F_10				
7478	ICAO_B	7	2	Climb	MaxTakeoff	F_10	1 000			
7478	ICAO_B	7	3	Accelerate_Percent	MaxTakeoff	F_10			231	55
7478	ICAO_B	7	4	Accelerate_Percent	MaxTakeoff	F_5			270	55
7478	ICAO_B	7	5	Climb	MaxTakeoff	F_1	2 610			
7478	ICAO_B	7	6	Accelerate_Percent	MaxClimb	F_0			300	50
7478	ICAO_B	7	7	Climb	MaxClimb	F_0	10 000			
7478	ICAO_B	8	1	Takeoff	MaxTakeoff	F_10				
7478	ICAO_B	8	2	Climb	MaxTakeoff	F_10	1 000			
7478	ICAO_B	8	3	Accelerate_Percent	MaxTakeoff	F_10			235	55
7478	ICAO_B	8	4	Accelerate_Percent	MaxTakeoff	F_5			265	55
7478	ICAO_B	8	5	Accelerate_Percent	MaxTakeoff	F_1			275	55
7478	ICAO_B	8	6	Climb	MaxClimb	F_0	10 000			
7478	ICAO_B	9	1	Takeoff	MaxTakeoff	F_10				
7478	ICAO_B	9	2	Climb	MaxTakeoff	F_10	1 000			

ACFTID	Profile_ID	Stage Length	Step Number	Step Type	Thrust Rating	Flap_ID	End Point Altitude (ft)	Rate Of Climb (ft/min)	End Point CAS (kt)	Accelerate_Percent (%)
7478	ICAO_B	9	3	Accelerate_Percent	MaxTakeoff	F_10			240	55
7478	ICAO_B	9	4	Accelerate_Percent	MaxTakeoff	F_5			270	55
7478	ICAO_B	9	5	Accelerate_Percent	MaxTakeoff	F_1			280	55
7478	ICAO_B	9	6	Climb	MaxClimb	F_0	10 000			
747SP	DEFAULT	1	1	Takeoff	MaxTakeoff	10				
747SP	DEFAULT	1	2	Climb	MaxTakeoff	10	1 000			
747SP	DEFAULT	1	3	Accelerate	MaxTakeoff	10		2 469	163	
747SP	DEFAULT	1	4	Accelerate	MaxClimb	5		1 000	203	
747SP	DEFAULT	1	5	Climb	MaxClimb	ZERO	3 000			
747SP	DEFAULT	1	6	Accelerate	MaxClimb	ZERO		1 000	250	
747SP	DEFAULT	1	7	Climb	MaxClimb	ZERO	5 500			
747SP	DEFAULT	1	8	Climb	MaxClimb	ZERO	7 500			
747SP	DEFAULT	1	9	Climb	MaxClimb	ZERO	10 000			
747SP	DEFAULT	2	1	Takeoff	MaxTakeoff	10				
747SP	DEFAULT	2	2	Climb	MaxTakeoff	10	1 000			
747SP	DEFAULT	2	3	Accelerate	MaxTakeoff	10		2 326	167	
747SP	DEFAULT	2	4	Accelerate	MaxClimb	5		1 000	207	
747SP	DEFAULT	2	5	Climb	MaxClimb	ZERO	3 000			
747SP	DEFAULT	2	6	Accelerate	MaxClimb	ZERO		1 000	250	
747SP	DEFAULT	2	7	Climb	MaxClimb	ZERO	5 500			

ACFTID	Profile_ID	Stage Length	Step Number	Step Type	Thrust Rating	Flap_ID	End Point Altitude (ft)	Rate Of Climb (ft/min)	End Point CAS (kt)	Accelerate_Percent (%)
747SP	DEFAULT	2	8	Climb	MaxClimb	ZERO	7 500			
747SP	DEFAULT	2	9	Climb	MaxClimb	ZERO	10 000			
747SP	DEFAULT	3	1	Takeoff	MaxTakeoff	10				
747SP	DEFAULT	3	2	Climb	MaxTakeoff	10	1 000			
747SP	DEFAULT	3	3	Accelerate	MaxTakeoff	10		2 201	170	
747SP	DEFAULT	3	4	Accelerate	MaxClimb	5		1 000	210	
747SP	DEFAULT	3	5	Climb	MaxClimb	ZERO	3 000			
747SP	DEFAULT	3	6	Accelerate	MaxClimb	ZERO		1 000	250	
747SP	DEFAULT	3	7	Climb	MaxClimb	ZERO	5 500			
747SP	DEFAULT	3	8	Climb	MaxClimb	ZERO	7 500			
747SP	DEFAULT	3	9	Climb	MaxClimb	ZERO	10 000			
747SP	DEFAULT	4	1	Takeoff	MaxTakeoff	10				
747SP	DEFAULT	4	2	Climb	MaxTakeoff	10	1 000			
747SP	DEFAULT	4	3	Accelerate	MaxTakeoff	10		2 027	175	
747SP	DEFAULT	4	4	Accelerate	MaxClimb	5		1 000	215	
747SP	DEFAULT	4	5	Climb	MaxClimb	ZERO	3 000			
747SP	DEFAULT	4	6	Accelerate	MaxClimb	ZERO		1 000	250	
747SP	DEFAULT	4	7	Climb	MaxClimb	ZERO	5 500			
747SP	DEFAULT	4	8	Climb	MaxClimb	ZERO	7 500			
747SP	DEFAULT	4	9	Climb	MaxClimb	ZERO	10 000			

ACFTID	Profile_ID	Stage Length	Step Number	Step Type	Thrust Rating	Flap_ID	End Point Altitude (ft)	Rate Of Climb (ft/min)	End Point CAS (kt)	Accelerate_Percent (%)
747SP	DEFAULT	5	1	Takeoff	MaxTakeoff	10				
747SP	DEFAULT	5	2	Climb	MaxTakeoff	10	1 000			
747SP	DEFAULT	5	3	Accelerate	MaxTakeoff	10		1 821	182	
747SP	DEFAULT	5	4	Accelerate	MaxClimb	5		1 000	222	
747SP	DEFAULT	5	5	Climb	MaxClimb	ZERO	3 000			
747SP	DEFAULT	5	6	Accelerate	MaxClimb	ZERO		1 000	250	
747SP	DEFAULT	5	7	Climb	MaxClimb	ZERO	5 500			
747SP	DEFAULT	5	8	Climb	MaxClimb	ZERO	7 500			
747SP	DEFAULT	5	9	Climb	MaxClimb	ZERO	10 000			
747SP	DEFAULT	6	1	Takeoff	MaxTakeoff	10				
747SP	DEFAULT	6	2	Climb	MaxTakeoff	10	1 000			
747SP	DEFAULT	6	3	Accelerate	MaxTakeoff	10		1 643	188	
747SP	DEFAULT	6	4	Accelerate	MaxClimb	5		1 000	228	
747SP	DEFAULT	6	5	Climb	MaxClimb	ZERO	3 000			
747SP	DEFAULT	6	6	Accelerate	MaxClimb	ZERO		1 000	250	
747SP	DEFAULT	6	7	Climb	MaxClimb	ZERO	5 500			
747SP	DEFAULT	6	8	Climb	MaxClimb	ZERO	7 500			
747SP	DEFAULT	6	9	Climb	MaxClimb	ZERO	10 000			

Table I-4 (part 2)

Default departures procedural steps

ACFTID	Profile_ID	Stage Length	Step Number	Step Type	Thrust Rating	Flap_ID	End Point Altitude (ft)	Rate Of Climb (ft/min)	End Point CAS (kt)	Accelerate_Percent (%)
747SP	DEFAULT	7	1	Takeoff	MaxTakeoff	10				
747SP	DEFAULT	7	2	Climb	MaxTakeoff	10	1 000			
747SP	DEFAULT	7	3	Accelerate	MaxTakeoff	10		1 403	196	
747SP	DEFAULT	7	4	Accelerate	MaxClimb	5		1 000	236	
747SP	DEFAULT	7	5	Accelerate	MaxClimb	ZERO		1 000	250	
747SP	DEFAULT	7	6	Climb	MaxClimb	ZERO	5 500			
747SP	DEFAULT	7	7	Climb	MaxClimb	ZERO	7 500			
747SP	DEFAULT	7	8	Climb	MaxClimb	ZERO	10 000			
757300	DEFAULT	1	1	Takeoff	MaxTakeoff	T_05				
757300	DEFAULT	1	2	Climb	MaxTakeoff	T_05	1 097			
757300	DEFAULT	1	3	Accelerate	MaxTakeoff	T_05		2 252,1	211,8	
757300	DEFAULT	1	4	Accelerate	MaxTakeoff	T_01		2 480	215,4	
757300	DEFAULT	1	5	Climb	MaxTakeoff	T_00	2 569			
757300	DEFAULT	1	6	Climb	MaxClimb	T_00	3 000			
757300	DEFAULT	1	7	Accelerate	MaxClimb	T_00		1 701,7	250	
757300	DEFAULT	1	8	Climb	MaxClimb	T_00	5 500			
757300	DEFAULT	1	9	Climb	MaxClimb	T_00	7 500			
757300	DEFAULT	1	10	Climb	MaxClimb	T_00	10 000			

ACFTID	Profile_ID	Stage Length	Step Number	Step Type	Thrust Rating	Flap_ID	End Point Altitude (ft)	Rate Of Climb (ft/min)	End Point CAS (kt)	Accelerate_Percent (%)
757300	DEFAULT	2	1	Takeoff	MaxTakeoff	T_05				
757300	DEFAULT	2	2	Climb	MaxTakeoff	T_05	1 041			
757300	DEFAULT	2	3	Accelerate	MaxTakeoff	T_05		2 154,9	213	
757300	DEFAULT	2	4	Accelerate	MaxTakeoff	T_01		2 352	218,6	
757300	DEFAULT	2	5	Climb	MaxTakeoff	T_00	2 412			
757300	DEFAULT	2	6	Climb	MaxClimb	T_00	3 000			
757300	DEFAULT	2	7	Accelerate	MaxClimb	T_00		1 607,8	250	
757300	DEFAULT	2	8	Climb	MaxClimb	T_00	5 500			
757300	DEFAULT	2	9	Climb	MaxClimb	T_00	7 500			
757300	DEFAULT	2	10	Climb	MaxClimb	T_00	10 000			
757300	DEFAULT	3	1	Takeoff	MaxTakeoff	T_05				
757300	DEFAULT	3	2	Climb	MaxTakeoff	T_05	1 000			
757300	DEFAULT	3	3	Accelerate	MaxTakeoff	T_05		2 062	214,5	
757300	DEFAULT	3	4	Accelerate	MaxTakeoff	T_01		2 223,5	221,8	
757300	DEFAULT	3	5	Climb	MaxTakeoff	T_00	2 275			
757300	DEFAULT	3	6	Climb	MaxClimb	T_00	3 000			
757300	DEFAULT	3	7	Accelerate	MaxClimb	T_00		1 521,8	250	
757300	DEFAULT	3	8	Climb	MaxClimb	T_00	5 500			
757300	DEFAULT	3	9	Climb	MaxClimb	T_00	7 500			

ACFTID	Profile_ID	Stage Length	Step Number	Step Type	Thrust Rating	Flap_ID	End Point Altitude (ft)	Rate Of Climb (ft/min)	End Point CAS (kt)	Accelerate_Percent (%)
757300	DEFAULT	3	10	Climb	MaxClimb	T_00	10 000			
757300	DEFAULT	4	1	Takeoff	MaxTakeoff	T_05				
757300	DEFAULT	4	2	Climb	MaxTakeoff	T_05	1 000			
757300	DEFAULT	4	3	Accelerate	MaxTakeoff	T_05		1 901,4	217,4	
757300	DEFAULT	4	4	Accelerate	MaxTakeoff	T_01		2 061,8	228	
757300	DEFAULT	4	5	Climb	MaxTakeoff	T_00	2 099			
757300	DEFAULT	4	6	Climb	MaxClimb	T_00	3 000			
757300	DEFAULT	4	7	Accelerate	MaxClimb	T_00		1 374,1	250	
757300	DEFAULT	4	8	Climb	MaxClimb	T_00	5 500			
757300	DEFAULT	4	9	Climb	MaxClimb	T_00	7 500			
757300	DEFAULT	4	10	Climb	MaxClimb	T_00	10 000			
757300	DEFAULT	5	1	Takeoff	MaxTakeoff	T_05				
757300	DEFAULT	5	2	Climb	MaxTakeoff	T_05	1 000			
757300	DEFAULT	5	3	Accelerate	MaxTakeoff	T_05		1 729,2	221,7	
757300	DEFAULT	5	4	Accelerate	MaxTakeoff	T_01		1 881,8	236,7	
757300	DEFAULT	5	5	Climb	MaxTakeoff	T_00	1 891			
757300	DEFAULT	5	6	Climb	MaxClimb	T_00	3 000			
757300	DEFAULT	5	7	Accelerate	MaxClimb	T_00		1 227,3	250	
757300	DEFAULT	5	8	Climb	MaxClimb	T_00	5 500			
757300	DEFAULT	5	9	Climb	MaxClimb	T_00	7 500			

ACFTID	Profile_ID	Stage Length	Step Number	Step Type	Thrust Rating	Flap_ID	End Point Altitude (ft)	Rate Of Climb (ft/min)	End Point CAS (kt)	Accelerate_Percent (%)
757300	DEFAULT	5	10	Climb	MaxClimb	T_00	10 000			
757300	DEFAULT	6	1	Takeoff	MaxTakeoff	T_05				
757300	DEFAULT	6	2	Climb	MaxTakeoff	T_05	1 000			
757300	DEFAULT	6	3	Accelerate	MaxTakeoff	T_05		1 655	224	
757300	DEFAULT	6	4	Accelerate	MaxTakeoff	T_01		1 836,4	240,1	
757300	DEFAULT	6	5	Climb	MaxTakeoff	T_00	1 829			
757300	DEFAULT	6	6	Climb	MaxClimb	T_00	3 000			
757300	DEFAULT	6	7	Accelerate	MaxClimb	T_00		1 159,2	250	
757300	DEFAULT	6	8	Climb	MaxClimb	T_00	5 500			
757300	DEFAULT	6	9	Climb	MaxClimb	T_00	7 500			
757300	DEFAULT	6	10	Climb	MaxClimb	T_00	10 000			
757300	ICAO_A	1	1	Takeoff	MaxTakeoff	T_05				
757300	ICAO_A	1	2	Climb	MaxTakeoff	T_05	1 500			
757300	ICAO_A	1	3	Climb	MaxClimb	T_05	3 000			
757300	ICAO_A	1	4	Accelerate	MaxClimb	T_05		1 388,6	198	
757300	ICAO_A	1	5	Accelerate	MaxClimb	T_01		1 528,2	215	
757300	ICAO_A	1	6	Accelerate	MaxClimb	T_00		1 693,5	250	
757300	ICAO_A	1	7	Climb	MaxClimb	T_00	5 500			
757300	ICAO_A	1	8	Climb	MaxClimb	T_00	7 500			
757300	ICAO_A	1	9	Climb	MaxClimb	T_00	10 000			

ACFTID	Profile_ID	Stage Length	Step Number	Step Type	Thrust Rating	Flap_ID	End Point Altitude (ft)	Rate Of Climb (ft/min)	End Point CAS (kt)	Accelerate_Percent (%)
757300	ICAO_A	2	1	Takeoff	MaxTakeoff	T_05				
757300	ICAO_A	2	2	Climb	MaxTakeoff	T_05	1 500			
757300	ICAO_A	2	3	Climb	MaxClimb	T_05	3 000			
757300	ICAO_A	2	4	Accelerate	MaxClimb	T_05		1 304,9	199,6	
757300	ICAO_A	2	5	Accelerate	MaxClimb	T_01		1 441	215,6	
757300	ICAO_A	2	6	Accelerate	MaxClimb	T_00		1 597,7	250	
757300	ICAO_A	2	7	Climb	MaxClimb	T_00	5 500			
757300	ICAO_A	2	8	Climb	MaxClimb	T_00	7 500			
757300	ICAO_A	2	9	Climb	MaxClimb	T_00	10 000			
757300	ICAO_A	3	1	Takeoff	MaxTakeoff	T_05				
757300	ICAO_A	3	2	Climb	MaxTakeoff	T_05	1 500			
757300	ICAO_A	3	3	Climb	MaxClimb	T_05	3 000			
757300	ICAO_A	3	4	Accelerate	MaxClimb	T_05		1 242,3	201,6	
757300	ICAO_A	3	5	Accelerate	MaxClimb	T_01		1 357,6	216,7	
757300	ICAO_A	3	6	Accelerate	MaxClimb	T_00		1 500	250	
757300	ICAO_A	3	7	Climb	MaxClimb	T_00	5 500			
757300	ICAO_A	3	8	Climb	MaxClimb	T_00	7 500			
757300	ICAO_A	3	9	Climb	MaxClimb	T_00	10 000			
757300	ICAO_A	4	1	Takeoff	MaxTakeoff	T_05				
757300	ICAO_A	4	2	Climb	MaxTakeoff	T_05	1 500			

ACFTID	Profile_ID	Stage Length	Step Number	Step Type	Thrust Rating	Flap_ID	End Point Altitude (ft)	Rate Of Climb (ft/min)	End Point CAS (kt)	Accelerate_Percent (%)
757300	ICAO_A	4	3	Climb	MaxClimb	T_05	3 000			
757300	ICAO_A	4	4	Accelerate	MaxClimb	T_05		1 127,1	205,3	
757300	ICAO_A	4	5	Accelerate	MaxClimb	T_01		1 221,4	221,1	
757300	ICAO_A	4	6	Accelerate	MaxClimb	T_00		1 359,4	250	
757300	ICAO_A	4	7	Climb	MaxClimb	T_00	5 500			
757300	ICAO_A	4	8	Climb	MaxClimb	T_00	7 500			
757300	ICAO_A	4	9	Climb	MaxClimb	T_00	10 000			
757300	ICAO_A	5	1	Takeoff	MaxTakeoff	T_05				
757300	ICAO_A	5	2	Climb	MaxTakeoff	T_05	1 500			
757300	ICAO_A	5	3	Climb	MaxClimb	T_05	3 000			
757300	ICAO_A	5	4	Accelerate	MaxClimb	T_05		997,2	210,6	
757300	ICAO_A	5	5	Accelerate	MaxClimb	T_01		1 076	227,9	
757300	ICAO_A	5	6	Accelerate	MaxClimb	T_00		1 192	250	
757300	ICAO_A	5	7	Climb	MaxClimb	T_00	5 500			
757300	ICAO_A	5	8	Climb	MaxClimb	T_00	7 500			
757300	ICAO_A	5	9	Climb	MaxClimb	T_00	10 000			
757300	ICAO_A	6	1	Takeoff	MaxTakeoff	T_05				
757300	ICAO_A	6	2	Climb	MaxTakeoff	T_05	1 500			
757300	ICAO_A	6	3	Climb	MaxClimb	T_05	3 000			
757300	ICAO_A	6	4	Accelerate	MaxClimb	T_05		945,1	213,2	

ACFTID	Profile_ID	Stage Length	Step Number	Step Type	Thrust Rating	Flap_ID	End Point Altitude (ft)	Rate Of Climb (ft/min)	End Point CAS (kt)	Accelerate_Percent (%)
757300	ICAO_A	6	5	Accelerate	MaxClimb	T_01		1 031,2	230,6	
757300	ICAO_A	6	6	Accelerate	MaxClimb	T_00		1 127,9	250	
757300	ICAO_A	6	7	Climb	MaxClimb	T_00	5 500			
757300	ICAO_A	6	8	Climb	MaxClimb	T_00	7 500			
757300	ICAO_A	6	9	Climb	MaxClimb	T_00	10 000			
757300	ICAO_B	1	1	Takeoff	MaxTakeoff	T_05				
757300	ICAO_B	1	2	Climb	MaxTakeoff	T_05	1 097			
757300	ICAO_B	1	3	Accelerate	MaxTakeoff	T_05		2 252,1	211,8	
757300	ICAO_B	1	4	Accelerate	MaxTakeoff	T_01		2 480	215,4	
757300	ICAO_B	1	5	Climb	MaxTakeoff	T_00	2 569			
757300	ICAO_B	1	6	Climb	MaxClimb	T_00	3 000			
757300	ICAO_B	1	7	Accelerate	MaxClimb	T_00		1 701,7	250	
757300	ICAO_B	1	8	Climb	MaxClimb	T_00	5 500			
757300	ICAO_B	1	9	Climb	MaxClimb	T_00	7 500			
757300	ICAO_B	1	10	Climb	MaxClimb	T_00	10 000			
757300	ICAO_B	2	1	Takeoff	MaxTakeoff	T_05				
757300	ICAO_B	2	2	Climb	MaxTakeoff	T_05	1 041			
757300	ICAO_B	2	3	Accelerate	MaxTakeoff	T_05		2 154,9	213	
757300	ICAO_B	2	4	Accelerate	MaxTakeoff	T_01		2 352	218,6	
757300	ICAO_B	2	5	Climb	MaxTakeoff	T_00	2 412			

ACFTID	Profile_ID	Stage Length	Step Number	Step Type	Thrust Rating	Flap_ID	End Point Altitude (ft)	Rate Of Climb (ft/min)	End Point CAS (kt)	Accelerate_Percent (%)
757300	ICAO_B	2	6	Climb	MaxClimb	T_00	3 000			
757300	ICAO_B	2	7	Accelerate	MaxClimb	T_00		1 607,8	250	
757300	ICAO_B	2	8	Climb	MaxClimb	T_00	5 500			
757300	ICAO_B	2	9	Climb	MaxClimb	T_00	7 500			
757300	ICAO_B	2	10	Climb	MaxClimb	T_00	10 000			
757300	ICAO_B	3	1	Takeoff	MaxTakeoff	T_05				
757300	ICAO_B	3	2	Climb	MaxTakeoff	T_05	1 000			
757300	ICAO_B	3	3	Accelerate	MaxTakeoff	T_05		2 062	214,5	
757300	ICAO_B	3	4	Accelerate	MaxTakeoff	T_01		2 223,5	221,8	
757300	ICAO_B	3	5	Climb	MaxTakeoff	T_00	2 275			
757300	ICAO_B	3	6	Climb	MaxClimb	T_00	3 000			
757300	ICAO_B	3	7	Accelerate	MaxClimb	T_00		1 521,8	250	
757300	ICAO_B	3	8	Climb	MaxClimb	T_00	5 500			
757300	ICAO_B	3	9	Climb	MaxClimb	T_00	7 500			
757300	ICAO_B	3	10	Climb	MaxClimb	T_00	10 000			
757300	ICAO_B	4	1	Takeoff	MaxTakeoff	T_05				
757300	ICAO_B	4	2	Climb	MaxTakeoff	T_05	1 000			
757300	ICAO_B	4	3	Accelerate	MaxTakeoff	T_05		1 901,4	217,4	
757300	ICAO_B	4	4	Accelerate	MaxTakeoff	T_01		2 061,8	228	
757300	ICAO_B	4	5	Climb	MaxTakeoff	T_00	2 099			

ACFTID	Profile_ID	Stage Length	Step Number	Step Type	Thrust Rating	Flap_ID	End Point Altitude (ft)	Rate Of Climb (ft/min)	End Point CAS (kt)	Accelerate_Percent (%)
757300	ICAO_B	4	6	Climb	MaxClimb	T_00	3 000			
757300	ICAO_B	4	7	Accelerate	MaxClimb	T_00		1 374,1	250	
757300	ICAO_B	4	8	Climb	MaxClimb	T_00	5 500			
757300	ICAO_B	4	9	Climb	MaxClimb	T_00	7 500			
757300	ICAO_B	4	10	Climb	MaxClimb	T_00	10 000			
757300	ICAO_B	5	1	Takeoff	MaxTakeoff	T_05				
757300	ICAO_B	5	2	Climb	MaxTakeoff	T_05	1 000			
757300	ICAO_B	5	3	Accelerate	MaxTakeoff	T_05		1 729,2	221,7	
757300	ICAO_B	5	4	Accelerate	MaxTakeoff	T_01		1 881,8	236,7	
757300	ICAO_B	5	5	Climb	MaxTakeoff	T_00	1 891			
757300	ICAO_B	5	6	Climb	MaxClimb	T_00	3 000			
757300	ICAO_B	5	7	Accelerate	MaxClimb	T_00		1 227,3	250	
757300	ICAO_B	5	8	Climb	MaxClimb	T_00	5 500			
757300	ICAO_B	5	9	Climb	MaxClimb	T_00	7 500			
757300	ICAO_B	5	10	Climb	MaxClimb	T_00	10 000			
757300	ICAO_B	6	1	Takeoff	MaxTakeoff	T_05				
757300	ICAO_B	6	2	Climb	MaxTakeoff	T_05	1 000			
757300	ICAO_B	6	3	Accelerate	MaxTakeoff	T_05		1 655	224	
757300	ICAO_B	6	4	Accelerate	MaxTakeoff	T_01		1 836,4	240,1	
757300	ICAO_B	6	5	Climb	MaxTakeoff	T_00	1 829			

ACFTID	Profile_ID	Stage Length	Step Number	Step Type	Thrust Rating	Flap_ID	End Point Altitude (ft)	Rate Of Climb (ft/min)	End Point CAS (kt)	Accelerate_Percent (%)
757300	ICAO_B	6	6	Climb	MaxClimb	T_00	3 000			
757300	ICAO_B	6	7	Accelerate	MaxClimb	T_00		1 159,2	250	
757300	ICAO_B	6	8	Climb	MaxClimb	T_00	5 500			
757300	ICAO_B	6	9	Climb	MaxClimb	T_00	7 500			
757300	ICAO_B	6	10	Climb	MaxClimb	T_00	10 000			
757PW	DEFAULT	1	1	Takeoff	MaxTakeoff	5				
757PW	DEFAULT	1	2	Climb	MaxTakeoff	5	1 000			
757PW	DEFAULT	1	3	Accelerate	MaxClimb	T_05		1 471	190,1	
757PW	DEFAULT	1	4	Accelerate	MaxClimb	T_01		1 636,4	206	
757PW	DEFAULT	1	5	Climb	MaxClimb	T_00	3 000			
757PW	DEFAULT	1	6	Accelerate	MaxClimb	T_00		1 822,2	250	
757PW	DEFAULT	1	7	Climb	MaxClimb	ZERO	5 500			
757PW	DEFAULT	1	8	Climb	MaxClimb	ZERO	7 500			
757PW	DEFAULT	1	9	Climb	MaxClimb	ZERO	10 000			
757PW	DEFAULT	2	1	Takeoff	MaxTakeoff	5				
757PW	DEFAULT	2	2	Climb	MaxTakeoff	5	1 000			
757PW	DEFAULT	2	3	Accelerate	MaxClimb	T_05		1 403,6	191,4	
757PW	DEFAULT	2	4	Accelerate	MaxClimb	T_01		1 568,2	208,7	
757PW	DEFAULT	2	5	Climb	MaxClimb	T_00	3 000			
757PW	DEFAULT	2	6	Accelerate	MaxClimb	T_00		1 742,7	250	

ACFTID	Profile_ID	Stage Length	Step Number	Step Type	Thrust Rating	Flap_ID	End Point Altitude (ft)	Rate Of Climb (ft/min)	End Point CAS (kt)	Accelerate_Percent (%)
757PW	DEFAULT	2	7	Climb	MaxClimb	ZERO	5 500			
757PW	DEFAULT	2	8	Climb	MaxClimb	ZERO	7 500			
757PW	DEFAULT	2	9	Climb	MaxClimb	ZERO	10 000			
757PW	DEFAULT	3	1	Takeoff	MaxTakeoff	5				
757PW	DEFAULT	3	2	Climb	MaxTakeoff	5	1 000			
757PW	DEFAULT	3	3	Accelerate	MaxClimb	T_05		1 339,2	193	
757PW	DEFAULT	3	4	Accelerate	MaxClimb	T_01		1 495,9	211,1	
757PW	DEFAULT	3	5	Accelerate	MaxClimb	T_00		1 666,7	211,6	
757PW	DEFAULT	3	6	Climb	MaxClimb	T_00	3 000			
757PW	DEFAULT	3	7	Accelerate	MaxClimb	T_00		1 661	250	
757PW	DEFAULT	3	8	Climb	MaxClimb	ZERO	5 500			
757PW	DEFAULT	3	9	Climb	MaxClimb	ZERO	7 500			
757PW	DEFAULT	3	10	Climb	MaxClimb	ZERO	10 000			
757PW	DEFAULT	4	1	Takeoff	MaxTakeoff	5				
757PW	DEFAULT	4	2	Climb	MaxTakeoff	5	1 000			
757PW	DEFAULT	4	3	Accelerate	MaxClimb	T_05		1 213,5	196,4	
757PW	DEFAULT	4	4	Accelerate	MaxClimb	T_01		1 353,6	213,7	
757PW	DEFAULT	4	5	Accelerate	MaxClimb	T_00		1 460,3	217,4	
757PW	DEFAULT	4	6	Climb	MaxClimb	T_00	3 000			
757PW	DEFAULT	4	7	Accelerate	MaxClimb	T_00		1 510,6	250	

ACFTID	Profile_ID	Stage Length	Step Number	Step Type	Thrust Rating	Flap_ID	End Point Altitude (ft)	Rate Of Climb (ft/min)	End Point CAS (kt)	Accelerate_Percent (%)
757PW	DEFAULT	4	8	Climb	MaxClimb	ZERO	5 500			
757PW	DEFAULT	4	9	Climb	MaxClimb	ZERO	7 500			
757PW	DEFAULT	4	10	Climb	MaxClimb	ZERO	10 000			
757PW	DEFAULT	5	1	Takeoff	MaxTakeoff	5				
757PW	DEFAULT	5	2	Climb	MaxTakeoff	5	1 000			
757PW	DEFAULT	5	3	Accelerate	MaxClimb	T_05		1 082,9	200,8	
757PW	DEFAULT	5	4	Accelerate	MaxClimb	T_01		1 212	218,5	
757PW	DEFAULT	5	5	Accelerate	MaxClimb	T_00		1 291,1	224,3	
757PW	DEFAULT	5	6	Climb	MaxClimb	T_00	3 000			
757PW	DEFAULT	5	7	Accelerate	MaxClimb	T_00		1 352,4	250	
757PW	DEFAULT	5	8	Climb	MaxClimb	ZERO	5 500			
757PW	DEFAULT	5	9	Climb	MaxClimb	ZERO	7 500			
757PW	DEFAULT	5	10	Climb	MaxClimb	ZERO	10 000			
757PW	DEFAULT	6	1	Takeoff	MaxTakeoff	5				
757PW	DEFAULT	6	2	Climb	MaxTakeoff	5	1 000			
757PW	DEFAULT	6	3	Accelerate	MaxClimb	T_05		1 005,7	203,9	
757PW	DEFAULT	6	4	Accelerate	MaxClimb	T_01		1 124,3	221,9	
757PW	DEFAULT	6	5	Accelerate	MaxClimb	T_00		1 220	228,7	
757PW	DEFAULT	6	6	Climb	MaxClimb	T_00	3 000			
757PW	DEFAULT	6	7	Accelerate	MaxClimb	T_00		1 259,5	250	

ACFTID	Profile_ID	Stage Length	Step Number	Step Type	Thrust Rating	Flap_ID	End Point Altitude (ft)	Rate Of Climb (ft/min)	End Point CAS (kt)	Accelerate_Percent (%)
757PW	DEFAULT	6	8	Climb	MaxClimb	ZERO	5 500			
757PW	DEFAULT	6	9	Climb	MaxClimb	ZERO	7 500			
757PW	DEFAULT	6	10	Climb	MaxClimb	ZERO	10 000			
757PW	DEFAULT	7	1	Takeoff	MaxTakeoff	5				
757PW	DEFAULT	7	2	Climb	MaxTakeoff	5	1 000			
757PW	DEFAULT	7	3	Accelerate	MaxClimb	T_05		938,1	207	
757PW	DEFAULT	7	4	Accelerate	MaxClimb	T_01		1 052,4	225,2	
757PW	DEFAULT	7	5	Accelerate	MaxClimb	T_00		1 134,5	233,3	
757PW	DEFAULT	7	6	Climb	MaxClimb	T_00	3 000			
757PW	DEFAULT	7	7	Accelerate	MaxClimb	T_00		1 172,9	250	
757PW	DEFAULT	7	8	Climb	MaxClimb	ZERO	5 500			
757PW	DEFAULT	7	9	Climb	MaxClimb	ZERO	7 500			
757PW	DEFAULT	7	10	Climb	MaxClimb	ZERO	10 000			
757PW	ICAO_A	1	1	Takeoff	MaxTakeoff	5				
757PW	ICAO_A	1	2	Climb	MaxTakeoff	5	1 500			
757PW	ICAO_A	1	3	Climb	MaxClimb	T_05	3 000			
757PW	ICAO_A	1	4	Accelerate	MaxClimb	T_05		1 399,5	188	
757PW	ICAO_A	1	5	Accelerate	MaxClimb	T_01		1 605,4	205,8	
757PW	ICAO_A	1	6	Accelerate	MaxClimb	ZERO		1 804,8	250	
757PW	ICAO_A	1	7	Climb	MaxClimb	ZERO	5 500			

ACFTID	Profile_ID	Stage Length	Step Number	Step Type	Thrust Rating	Flap_ID	End Point Altitude (ft)	Rate Of Climb (ft/min)	End Point CAS (kt)	Accelerate_Percent (%)
757PW	ICAO_A	1	8	Climb	MaxClimb	ZERO	7 500			
757PW	ICAO_A	1	9	Climb	MaxClimb	ZERO	10 000			
757PW	ICAO_A	2	1	Takeoff	MaxTakeoff	5				
757PW	ICAO_A	2	2	Climb	MaxTakeoff	5	1 500			
757PW	ICAO_A	2	3	Climb	MaxClimb	T_05	3 000			
757PW	ICAO_A	2	4	Accelerate	MaxClimb	T_05		1 337,7	189,5	
757PW	ICAO_A	2	5	Accelerate	MaxClimb	T_01		1 522,3	207,2	
757PW	ICAO_A	2	6	Accelerate	MaxClimb	ZERO		1 725,5	250	
757PW	ICAO_A	2	7	Climb	MaxClimb	ZERO	5 500			
757PW	ICAO_A	2	8	Climb	MaxClimb	ZERO	7 500			
757PW	ICAO_A	2	9	Climb	MaxClimb	ZERO	10 000			
757PW	ICAO_A	3	1	Takeoff	MaxTakeoff	5				
757PW	ICAO_A	3	2	Climb	MaxTakeoff	5	1 500			
757PW	ICAO_A	3	3	Climb	MaxClimb	5	3 000			
757PW	ICAO_A	3	4	Accelerate	MaxClimb	T_05		1 271,9	191,1	
757PW	ICAO_A	3	5	Accelerate	MaxClimb	T_01		1 451,8	208,2	
757PW	ICAO_A	3	6	Accelerate	MaxClimb	ZERO		1 638	250	
757PW	ICAO_A	3	7	Climb	MaxClimb	ZERO	5 500			
757PW	ICAO_A	3	8	Climb	MaxClimb	ZERO	7 500			
757PW	ICAO_A	3	9	Climb	MaxClimb	ZERO	10 000			

ACFTID	Profile_ID	Stage Length	Step Number	Step Type	Thrust Rating	Flap_ID	End Point Altitude (ft)	Rate Of Climb (ft/min)	End Point CAS (kt)	Accelerate_Percent (%)
757PW	ICAO_A	4	1	Takeoff	MaxTakeoff	5				
757PW	ICAO_A	4	2	Climb	MaxTakeoff	5	1 500			
757PW	ICAO_A	4	3	Climb	MaxClimb	5	3 000			
757PW	ICAO_A	4	4	Accelerate	MaxClimb	T_05		1 153,8	194,7	
757PW	ICAO_A	4	5	Accelerate	MaxClimb	T_01		1 312,6	212,2	
757PW	ICAO_A	4	6	Accelerate	MaxClimb	ZERO		1 486	250	
757PW	ICAO_A	4	7	Climb	MaxClimb	ZERO	5 500			
757PW	ICAO_A	4	8	Climb	MaxClimb	ZERO	7 500			
757PW	ICAO_A	4	9	Climb	MaxClimb	ZERO	10 000			
757PW	ICAO_A	5	1	Takeoff	MaxTakeoff	5				
757PW	ICAO_A	5	2	Climb	MaxTakeoff	5	1 500			
757PW	ICAO_A	5	3	Climb	MaxClimb	5	3 000			
757PW	ICAO_A	5	4	Accelerate	MaxClimb	T_05		1 028,8	199,2	
757PW	ICAO_A	5	5	Accelerate	MaxClimb	T_01		1 171,1	217,2	
757PW	ICAO_A	5	6	Accelerate	MaxClimb	ZERO		1 325,6	250	
757PW	ICAO_A	5	7	Climb	MaxClimb	ZERO	5 500			
757PW	ICAO_A	5	8	Climb	MaxClimb	ZERO	7 500			
757PW	ICAO_A	5	9	Climb	MaxClimb	ZERO	10 000			
757PW	ICAO_A	6	1	Takeoff	MaxTakeoff	5				
757PW	ICAO_A	6	2	Climb	MaxTakeoff	5	1 500			

ACFTID	Profile_ID	Stage Length	Step Number	Step Type	Thrust Rating	Flap_ID	End Point Altitude (ft)	Rate Of Climb (ft/min)	End Point CAS (kt)	Accelerate_Percent (%)
757PW	ICAO_A	6	3	Climb	MaxClimb	5	3 000			
757PW	ICAO_A	6	4	Accelerate	MaxClimb	T_05		953,4	202,5	
757PW	ICAO_A	6	5	Accelerate	MaxClimb	T_01		1 087,8	220,6	
757PW	ICAO_A	6	6	Accelerate	MaxClimb	ZERO		1 225,5	250	
757PW	ICAO_A	6	7	Climb	MaxClimb	ZERO	5 500			
757PW	ICAO_A	6	8	Climb	MaxClimb	ZERO	7 500			
757PW	ICAO_A	6	9	Climb	MaxClimb	ZERO	10 000			
757PW	ICAO_A	7	1	Takeoff	MaxTakeoff	5				
757PW	ICAO_A	7	2	Climb	MaxTakeoff	5	1 500			
757PW	ICAO_A	7	3	Climb	MaxClimb	5	3 000			
757PW	ICAO_A	7	4	Accelerate	MaxClimb	T_05		886,5	205,7	
757PW	ICAO_A	7	5	Accelerate	MaxClimb	T_01		1 012,8	224	
757PW	ICAO_A	7	6	Accelerate	MaxClimb	ZERO		1 140,1	250	
757PW	ICAO_A	7	7	Climb	MaxClimb	ZERO	5 500			
757PW	ICAO_A	7	8	Climb	MaxClimb	ZERO	7 500			
757PW	ICAO_A	7	9	Climb	MaxClimb	ZERO	10 000			
757PW	ICAO_B	1	1	Takeoff	MaxTakeoff	5				
757PW	ICAO_B	1	2	Climb	MaxTakeoff	5	1 000			
757PW	ICAO_B	1	3	Accelerate	MaxTakeoff	5		1 970,1	206	
757PW	ICAO_B	1	4	Climb	MaxClimb	ZERO	3 000			

ACFTID	Profile_ID	Stage Length	Step Number	Step Type	Thrust Rating	Flap_ID	End Point Altitude (ft)	Rate Of Climb (ft/min)	End Point CAS (kt)	Accelerate_Percent (%)
757PW	ICAO_B	1	5	Accelerate	MaxClimb	ZERO		1 821,5	250	
757PW	ICAO_B	1	6	Climb	MaxClimb	ZERO	5 500			
757PW	ICAO_B	1	7	Climb	MaxClimb	ZERO	7 500			
757PW	ICAO_B	1	8	Climb	MaxClimb	ZERO	10 000			
757PW	ICAO_B	2	1	Takeoff	MaxTakeoff	5				
757PW	ICAO_B	2	2	Climb	MaxTakeoff	5	1 000			
757PW	ICAO_B	2	3	Accelerate	MaxTakeoff	5		1 899,2	208,7	
757PW	ICAO_B	2	4	Climb	MaxClimb	ZERO	3 000			
757PW	ICAO_B	2	5	Accelerate	MaxClimb	ZERO		1 743,3	250	
757PW	ICAO_B	2	6	Climb	MaxClimb	ZERO	5 500			
757PW	ICAO_B	2	7	Climb	MaxClimb	ZERO	7 500			
757PW	ICAO_B	2	8	Climb	MaxClimb	ZERO	10 000			
757PW	ICAO_B	3	1	Takeoff	MaxTakeoff	5				
757PW	ICAO_B	3	2	Climb	MaxTakeoff	5	1 000			
757PW	ICAO_B	3	3	Accelerate	MaxTakeoff	5		1 825,8	211,6	
757PW	ICAO_B	3	4	Climb	MaxClimb	ZERO	3 000			
757PW	ICAO_B	3	5	Accelerate	MaxClimb	ZERO		1 659,4	250	
757PW	ICAO_B	3	6	Climb	MaxClimb	ZERO	5 500			
757PW	ICAO_B	3	7	Climb	MaxClimb	ZERO	7 500			
757PW	ICAO_B	3	8	Climb	MaxClimb	ZERO	10 000			

ACFTID	Profile_ID	Stage Length	Step Number	Step Type	Thrust Rating	Flap_ID	End Point Altitude (ft)	Rate Of Climb (ft/min)	End Point CAS (kt)	Accelerate_Percent (%)
757PW	ICAO_B	4	1	Takeoff	MaxTakeoff	5				
757PW	ICAO_B	4	2	Climb	MaxTakeoff	5	1 000			
757PW	ICAO_B	4	3	Accelerate	MaxTakeoff	5		1 690,7	217,4	
757PW	ICAO_B	4	4	Climb	MaxClimb	ZERO	3 000			
757PW	ICAO_B	4	5	Accelerate	MaxClimb	ZERO		1 512,3	250	
757PW	ICAO_B	4	6	Climb	MaxClimb	ZERO	5 500			
757PW	ICAO_B	4	7	Climb	MaxClimb	ZERO	7 500			
757PW	ICAO_B	4	8	Climb	MaxClimb	ZERO	10 000			
757PW	ICAO_B	5	1	Takeoff	MaxTakeoff	5				
757PW	ICAO_B	5	2	Climb	MaxTakeoff	5	1 000			
757PW	ICAO_B	5	3	Accelerate	MaxTakeoff	5		1 543,6	224,1	
757PW	ICAO_B	5	4	Climb	MaxClimb	ZERO	3 000			
757PW	ICAO_B	5	5	Accelerate	MaxClimb	ZERO		1 351,8	250	
757PW	ICAO_B	5	6	Climb	MaxClimb	ZERO	5 500			
757PW	ICAO_B	5	7	Climb	MaxClimb	ZERO	7 500			
757PW	ICAO_B	5	8	Climb	MaxClimb	ZERO	10 000			
757PW	ICAO_B	6	1	Takeoff	MaxTakeoff	5				
757PW	ICAO_B	6	2	Climb	MaxTakeoff	5	1 000			
757PW	ICAO_B	6	3	Accelerate	MaxTakeoff	5		1 458,3	228,7	
757PW	ICAO_B	6	4	Climb	MaxClimb	ZERO	3 000			

ACFTID	Profile_ID	Stage Length	Step Number	Step Type	Thrust Rating	Flap_ID	End Point Altitude (ft)	Rate Of Climb (ft/min)	End Point CAS (kt)	Accelerate_Percent (%)
757PW	ICAO_B	6	5	Accelerate	MaxClimb	ZERO		1 257,5	250	
757PW	ICAO_B	6	6	Climb	MaxClimb	ZERO	5 500			
757PW	ICAO_B	6	7	Climb	MaxClimb	ZERO	7 500			
757PW	ICAO_B	6	8	Climb	MaxClimb	ZERO	10 000			
757PW	ICAO_B	7	1	Takeoff	MaxTakeoff	5				
757PW	ICAO_B	7	2	Climb	MaxTakeoff	5	1 000			
757PW	ICAO_B	7	3	Accelerate	MaxTakeoff	5		1 380,6	233,3	
757PW	ICAO_B	7	4	Climb	MaxClimb	ZERO	3 000			
757PW	ICAO_B	7	5	Accelerate	MaxClimb	ZERO		1 173,6	250	
757PW	ICAO_B	7	6	Climb	MaxClimb	ZERO	5 500			
757PW	ICAO_B	7	7	Climb	MaxClimb	ZERO	7 500			
757PW	ICAO_B	7	8	Climb	MaxClimb	ZERO	10 000			
757RR	DEFAULT	1	1	Takeoff	MaxTakeoff	5				
757RR	DEFAULT	1	2	Climb	MaxTakeoff	5	1 000			
757RR	DEFAULT	1	3	Accelerate	MaxClimb	T_05		1 613,9	192,4	
757RR	DEFAULT	1	4	Accelerate	MaxClimb	T_01		1 779,7	206,3	
757RR	DEFAULT	1	5	Climb	MaxClimb	ZERO	3 000			
757RR	DEFAULT	1	6	Accelerate	MaxClimb	ZERO		1 966,1	250	
757RR	DEFAULT	1	7	Climb	MaxClimb	ZERO	5 500			
757RR	DEFAULT	1	8	Climb	MaxClimb	ZERO	7 500			

ACFTID	Profile_ID	Stage Length	Step Number	Step Type	Thrust Rating	Flap_ID	End Point Altitude (ft)	Rate Of Climb (ft/min)	End Point CAS (kt)	Accelerate_Percent (%)
757RR	DEFAULT	1	9	Climb	MaxClimb	ZERO	10 000			
757RR	DEFAULT	2	1	Takeoff	MaxTakeoff	5				
757RR	DEFAULT	2	2	Climb	MaxTakeoff	5	1 000			
757RR	DEFAULT	2	3	Accelerate	MaxClimb	T_05		1 544,6	193,9	
757RR	DEFAULT	2	4	Accelerate	MaxClimb	T_01		1 703,3	209,2	
757RR	DEFAULT	2	5	Climb	MaxClimb	ZERO	3 000			
757RR	DEFAULT	2	6	Accelerate	MaxClimb	ZERO		1 879,3	250	
757RR	DEFAULT	2	7	Climb	MaxClimb	ZERO	5 500			
757RR	DEFAULT	2	8	Climb	MaxClimb	ZERO	7 500			
757RR	DEFAULT	2	9	Climb	MaxClimb	ZERO	10 000			
757RR	DEFAULT	3	1	Takeoff	MaxTakeoff	5				
757RR	DEFAULT	3	2	Climb	MaxTakeoff	5	1 000			
757RR	DEFAULT	3	3	Accelerate	MaxClimb	T_05		1 474,6	195,5	
757RR	DEFAULT	3	4	Accelerate	MaxClimb	T_01		1 627,6	212,2	
757RR	DEFAULT	3	5	Climb	MaxClimb	ZERO	3 000			
757RR	DEFAULT	3	6	Accelerate	MaxClimb	ZERO		1 787,2	250	
757RR	DEFAULT	3	7	Climb	MaxClimb	ZERO	5 500			
757RR	DEFAULT	3	8	Climb	MaxClimb	ZERO	7 500			
757RR	DEFAULT	3	9	Climb	MaxClimb	ZERO	10 000			
757RR	DEFAULT	4	1	Takeoff	MaxTakeoff	5				

ACFTID	Profile_ID	Stage Length	Step Number	Step Type	Thrust Rating	Flap_ID	End Point Altitude (ft)	Rate Of Climb (ft/min)	End Point CAS (kt)	Accelerate_Percent (%)
757RR	DEFAULT	4	2	Climb	MaxTakeoff	5	1 000			
757RR	DEFAULT	4	3	Accelerate	MaxClimb	T_05		1 338	199	
757RR	DEFAULT	4	4	Accelerate	MaxClimb	T_01		1 484,6	216,4	
757RR	DEFAULT	4	5	Accelerate	MaxClimb	ZERO		1 560	218,3	
757RR	DEFAULT	4	6	Climb	MaxClimb	ZERO	3 000			
757RR	DEFAULT	4	7	Accelerate	MaxClimb	ZERO		1 623,1	250	
757RR	DEFAULT	4	8	Climb	MaxClimb	T_00	5 500			
757RR	DEFAULT	4	9	Climb	MaxClimb	T_00	7 500			
757RR	DEFAULT	4	10	Climb	MaxClimb	T_00	10 000			
757RR	DEFAULT	5	1	Takeoff	MaxTakeoff	5				
757RR	DEFAULT	5	2	Climb	MaxTakeoff	5	1 000			
757RR	DEFAULT	5	3	Accelerate	MaxClimb	T_05		1 196,6	203,7	
757RR	DEFAULT	5	4	Accelerate	MaxClimb	T_01		1 325,3	221,1	
757RR	DEFAULT	5	5	Accelerate	MaxClimb	T_00		1 400	225,7	
757RR	DEFAULT	5	6	Climb	MaxClimb	ZERO	3 000			
757RR	DEFAULT	5	7	Accelerate	MaxClimb	ZERO		1 447,1	250	
757RR	DEFAULT	5	8	Climb	MaxClimb	T_00	5 500			
757RR	DEFAULT	5	9	Climb	MaxClimb	T_00	7 500			
757RR	DEFAULT	5	10	Climb	MaxClimb	ZERO	10 000			
757RR	DEFAULT	6	1	Takeoff	MaxTakeoff	5				

ACFTID	Profile_ID	Stage Length	Step Number	Step Type	Thrust Rating	Flap_ID	End Point Altitude (ft)	Rate Of Climb (ft/min)	End Point CAS (kt)	Accelerate_Percent (%)
757RR	DEFAULT	6	2	Climb	MaxTakeoff	5	1 000			
757RR	DEFAULT	6	3	Accelerate	MaxClimb	T_05		1 142,2	205,8	
757RR	DEFAULT	6	4	Accelerate	MaxClimb	T_01		1 258	223,4	
757RR	DEFAULT	6	5	Accelerate	MaxClimb	T_00		1 329,6	228,9	
757RR	DEFAULT	6	6	Climb	MaxClimb	ZERO	3 000			
757RR	DEFAULT	6	7	Accelerate	MaxClimb	ZERO		1 377,4	250	
757RR	DEFAULT	6	8	Climb	MaxClimb	T_00	5 500			
757RR	DEFAULT	6	9	Climb	MaxClimb	T_00	7 500			
757RR	DEFAULT	6	10	Climb	MaxClimb	ZERO	10 000			
757RR	DEFAULT	7	1	Takeoff	MaxTakeoff	5				
757RR	DEFAULT	7	2	Climb	MaxTakeoff	5	1 000			
757RR	DEFAULT	7	3	Accelerate	MaxClimb	T_05		1 071,3	208,8	
757RR	DEFAULT	7	4	Accelerate	MaxClimb	T_01		1 181,5	226,7	
757RR	DEFAULT	7	5	Accelerate	MaxClimb	T_00		1 265,9	233,3	
757RR	DEFAULT	7	6	Climb	MaxClimb	ZERO	3 000			
757RR	DEFAULT	7	7	Accelerate	MaxClimb	ZERO		1 287,6	250	
757RR	DEFAULT	7	8	Climb	MaxClimb	T_00	5 500			
757RR	DEFAULT	7	9	Climb	MaxClimb	ZERO	7 500			
757RR	DEFAULT	7	10	Climb	MaxClimb	ZERO	10 000			
757RR	ICAO_A	1	1	Takeoff	MaxTakeoff	5				

ACFTID	Profile_ID	Stage Length	Step Number	Step Type	Thrust Rating	Flap_ID	End Point Altitude (ft)	Rate Of Climb (ft/min)	End Point CAS (kt)	Accelerate_Percent (%)
757RR	ICAO_A	1	2	Climb	MaxTakeoff	5	1 500			
757RR	ICAO_A	1	3	Climb	MaxClimb	5	3 000			
757RR	ICAO_A	1	4	Accelerate	MaxClimb	T_05		1 543,3	190,3	
757RR	ICAO_A	1	5	Accelerate	MaxClimb	T_01		1 735,6	206,1	
757RR	ICAO_A	1	6	Accelerate	MaxClimb	T_00		1 959,8	250	
757RR	ICAO_A	1	7	Climb	MaxClimb	ZERO	5 500			
757RR	ICAO_A	1	8	Climb	MaxClimb	ZERO	7 500			
757RR	ICAO_A	1	9	Climb	MaxClimb	ZERO	10 000			
757RR	ICAO_A	2	1	Takeoff	MaxTakeoff	5				
757RR	ICAO_A	2	2	Climb	MaxTakeoff	5	1 500			
757RR	ICAO_A	2	3	Climb	MaxClimb	5	3 000			
757RR	ICAO_A	2	4	Accelerate	MaxClimb	T_05		1 472,7	191,9	
757RR	ICAO_A	2	5	Accelerate	MaxClimb	T_01		1 660,2	208,9	
757RR	ICAO_A	2	6	Accelerate	MaxClimb	T_00		1 876	250	
757RR	ICAO_A	2	7	Climb	MaxClimb	ZERO	5 500			
757RR	ICAO_A	2	8	Climb	MaxClimb	ZERO	7 500			
757RR	ICAO_A	2	9	Climb	MaxClimb	ZERO	10 000			
757RR	ICAO_A	3	1	Takeoff	MaxTakeoff	5				
757RR	ICAO_A	3	2	Climb	MaxTakeoff	5	1 500			
757RR	ICAO_A	3	3	Climb	MaxClimb	5	3 000			

ACFTID	Profile_ID	Stage Length	Step Number	Step Type	Thrust Rating	Flap_ID	End Point Altitude (ft)	Rate Of Climb (ft/min)	End Point CAS (kt)	Accelerate_Percent (%)
757RR	ICAO_A	3	4	Accelerate	MaxClimb	T_05		1 401	193,6	
757RR	ICAO_A	3	5	Accelerate	MaxClimb	T_01		1 590,6	211,5	
757RR	ICAO_A	3	6	Accelerate	MaxClimb	T_00		1 769,2	250	
757RR	ICAO_A	3	7	Climb	MaxClimb	ZERO	5 500			
757RR	ICAO_A	3	8	Climb	MaxClimb	ZERO	7 500			
757RR	ICAO_A	3	9	Climb	MaxClimb	ZERO	10 000			
757RR	ICAO_A	4	1	Takeoff	MaxTakeoff	5				
757RR	ICAO_A	4	2	Climb	MaxTakeoff	5	1 500			
757RR	ICAO_A	4	3	Climb	MaxClimb	5	3 000			
757RR	ICAO_A	4	4	Accelerate	MaxClimb	T_05		1 271,5	197,3	
757RR	ICAO_A	4	5	Accelerate	MaxClimb	T_01		1 436	214,5	
757RR	ICAO_A	4	6	Accelerate	MaxClimb	T_00		1 593,3	250	
757RR	ICAO_A	4	7	Climb	MaxClimb	ZERO	5 500			
757RR	ICAO_A	4	8	Climb	MaxClimb	ZERO	7 500			
757RR	ICAO_A	4	9	Climb	MaxClimb	T_00	10 000			
757RR	ICAO_A	5	1	Takeoff	MaxTakeoff	5				
757RR	ICAO_A	5	2	Climb	MaxTakeoff	5	1 500			
757RR	ICAO_A	5	3	Climb	MaxClimb	5	3 000			
757RR	ICAO_A	5	4	Accelerate	MaxClimb	T_05		1 134,7	202,1	
757RR	ICAO_A	5	5	Accelerate	MaxClimb	T_01		1 278,3	219,8	

ACFTID	Profile_ID	Stage Length	Step Number	Step Type	Thrust Rating	Flap_ID	End Point Altitude (ft)	Rate Of Climb (ft/min)	End Point CAS (kt)	Accelerate_Percent (%)
757RR	ICAO_A	5	6	Accelerate	MaxClimb	T_00		1 416,8	250	
757RR	ICAO_A	5	7	Climb	MaxClimb	ZERO	5 500			
757RR	ICAO_A	5	8	Climb	MaxClimb	ZERO	7 500			
757RR	ICAO_A	5	9	Climb	MaxClimb	ZERO	10 000			
757RR	ICAO_A	6	1	Takeoff	MaxTakeoff	5				
757RR	ICAO_A	6	2	Climb	MaxTakeoff	5	1 500			
757RR	ICAO_A	6	3	Climb	MaxClimb	5	3 000			
757RR	ICAO_A	6	4	Accelerate	MaxClimb	T_05		1 083,2	204,3	
757RR	ICAO_A	6	5	Accelerate	MaxClimb	T_01		1 218,6	222,1	
757RR	ICAO_A	6	6	Accelerate	MaxClimb	T_00		1 348,5	250	
757RR	ICAO_A	6	7	Climb	MaxClimb	ZERO	5 500			
757RR	ICAO_A	6	8	Climb	MaxClimb	ZERO	7 500			
757RR	ICAO_A	6	9	Climb	MaxClimb	ZERO	10 000			
757RR	ICAO_A	7	1	Takeoff	MaxTakeoff	5				
757RR	ICAO_A	7	2	Climb	MaxTakeoff	5	1 500			
757RR	ICAO_A	7	3	Climb	MaxClimb	5	3 000			
757RR	ICAO_A	7	4	Accelerate	MaxClimb	T_05		1 013,1	207,4	
757RR	ICAO_A	7	5	Accelerate	MaxClimb	T_01		1 137,3	225,4	
757RR	ICAO_A	7	6	Accelerate	MaxClimb	ZERO		1 256,7	250	
757RR	ICAO_A	7	7	Climb	MaxClimb	ZERO	5 500			

ACFTID	Profile_ID	Stage Length	Step Number	Step Type	Thrust Rating	Flap_ID	End Point Altitude (ft)	Rate Of Climb (ft/min)	End Point CAS (kt)	Accelerate_Percent (%)
757RR	ICAO_A	7	8	Climb	MaxClimb	ZERO	7 500			
757RR	ICAO_A	7	9	Climb	MaxClimb	ZERO	10 000			
757RR	ICAO_B	1	1	Takeoff	MaxTakeoff	5				
757RR	ICAO_B	1	2	Climb	MaxTakeoff	5	1 000			
757RR	ICAO_B	1	3	Accelerate	MaxTakeoff	T_05		2 227,2	201,9	
757RR	ICAO_B	1	4	Accelerate	MaxTakeoff	T_01		2 474,2	206,3	
757RR	ICAO_B	1	5	Climb	MaxClimb	ZERO	3 000			
757RR	ICAO_B	1	6	Accelerate	MaxClimb	ZERO		1 965,3	250	
757RR	ICAO_B	1	7	Climb	MaxClimb	ZERO	5 500			
757RR	ICAO_B	1	8	Climb	MaxClimb	ZERO	7 500			
757RR	ICAO_B	1	9	Climb	MaxClimb	ZERO	10 000			
757RR	ICAO_B	2	1	Takeoff	MaxTakeoff	5				
757RR	ICAO_B	2	2	Climb	MaxTakeoff	5	1 000			
757RR	ICAO_B	2	3	Accelerate	MaxTakeoff	T_05		2 139,9	203	
757RR	ICAO_B	2	4	Accelerate	MaxTakeoff	T_01		2 400	209,2	
757RR	ICAO_B	2	5	Climb	MaxClimb	ZERO	3 000			
757RR	ICAO_B	2	6	Accelerate	MaxClimb	T_00		1 876,9	250	
757RR	ICAO_B	2	7	Climb	MaxClimb	T_00	5 500			
757RR	ICAO_B	2	8	Climb	MaxClimb	ZERO	7 500			
757RR	ICAO_B	2	9	Climb	MaxClimb	ZERO	10 000			

ACFTID	Profile_ID	Stage Length	Step Number	Step Type	Thrust Rating	Flap_ID	End Point Altitude (ft)	Rate Of Climb (ft/min)	End Point CAS (kt)	Accelerate_Percent (%)
757RR	ICAO_B	3	1	Takeoff	MaxTakeoff	5				
757RR	ICAO_B	3	2	Climb	MaxTakeoff	5	1 000			
757RR	ICAO_B	3	3	Accelerate	MaxTakeoff	T_05		2 051,2	204,3	
757RR	ICAO_B	3	4	Accelerate	MaxTakeoff	T_01		2 300	212,1	
757RR	ICAO_B	3	5	Climb	MaxClimb	ZERO	3 000			
757RR	ICAO_B	3	6	Accelerate	MaxClimb	T_00		1 788	250	
757RR	ICAO_B	3	7	Climb	MaxClimb	T_00	5 500			
757RR	ICAO_B	3	8	Climb	MaxClimb	T_00	7 500			
757RR	ICAO_B	3	9	Climb	MaxClimb	ZERO	10 000			
757RR	ICAO_B	4	1	Takeoff	MaxTakeoff	5				
757RR	ICAO_B	4	2	Climb	MaxTakeoff	5	1 000			
757RR	ICAO_B	4	3	Accelerate	MaxTakeoff	T_05		1 884,9	207,3	
757RR	ICAO_B	4	4	Accelerate	MaxTakeoff	T_01		2 135,6	218,4	
757RR	ICAO_B	4	5	Climb	MaxClimb	T_00	3 000			
757RR	ICAO_B	4	6	Accelerate	MaxClimb	T_00		1 621,6	250	
757RR	ICAO_B	4	7	Climb	MaxClimb	T_00	5 500			
757RR	ICAO_B	4	8	Climb	MaxClimb	T_00	7 500			
757RR	ICAO_B	4	9	Climb	MaxClimb	T_00	10 000			
757RR	ICAO_B	5	1	Takeoff	MaxTakeoff	5				
757RR	ICAO_B	5	2	Climb	MaxTakeoff	5	1 000			

ACFTID	Profile_ID	Stage Length	Step Number	Step Type	Thrust Rating	Flap_ID	End Point Altitude (ft)	Rate Of Climb (ft/min)	End Point CAS (kt)	Accelerate_Percent (%)
757RR	ICAO_B	5	3	Accelerate	MaxTakeoff	T_05		1 713,8	211,3	
757RR	ICAO_B	5	4	Accelerate	MaxTakeoff	T_01		1 935,5	225,8	
757RR	ICAO_B	5	5	Climb	MaxClimb	ZERO	3 000			
757RR	ICAO_B	5	6	Accelerate	MaxClimb	T_00		1 447,1	250	
757RR	ICAO_B	5	7	Climb	MaxClimb	T_00	5 500			
757RR	ICAO_B	5	8	Climb	MaxClimb	T_00	7 500			
757RR	ICAO_B	5	9	Climb	MaxClimb	T_00	10 000			
757RR	ICAO_B	6	1	Takeoff	MaxTakeoff	5				
757RR	ICAO_B	6	2	Climb	MaxTakeoff	5	1 000			
757RR	ICAO_B	6	3	Accelerate	MaxTakeoff	T_05		1 646,9	213,1	
757RR	ICAO_B	6	4	Accelerate	MaxTakeoff	T_01		1 872,3	228,9	
757RR	ICAO_B	6	5	Climb	MaxClimb	ZERO	3 000			
757RR	ICAO_B	6	6	Accelerate	MaxClimb	T_00		1 379,1	250	
757RR	ICAO_B	6	7	Climb	MaxClimb	T_00	5 500			
757RR	ICAO_B	6	8	Climb	MaxClimb	T_00	7 500			
757RR	ICAO_B	6	9	Climb	MaxClimb	T_00	10 000			
757RR	ICAO_B	7	1	Takeoff	MaxTakeoff	5				
757RR	ICAO_B	7	2	Climb	MaxTakeoff	5	1 000			
757RR	ICAO_B	7	3	Accelerate	MaxTakeoff	T_05		1 562,1	215,8	
757RR	ICAO_B	7	4	Accelerate	MaxTakeoff	T_01		1 781,3	233,3	

ACFTID	Profile_ID	Stage Length	Step Number	Step Type	Thrust Rating	Flap_ID	End Point Altitude (ft)	Rate Of Climb (ft/min)	End Point CAS (kt)	Accelerate_Percent (%)
757RR	ICAO_B	7	5	Climb	MaxClimb	ZERO	3 000			
757RR	ICAO_B	7	6	Accelerate	MaxClimb	T_00		1 287,6	250	
757RR	ICAO_B	7	7	Climb	MaxClimb	T_00	5 500			
757RR	ICAO_B	7	8	Climb	MaxClimb	T_00	7 500			
757RR	ICAO_B	7	9	Climb	MaxClimb	T_00	10 000			
767300	DEFAULT	1	1	Takeoff	MaxTakeoff	15				
767300	DEFAULT	1	2	Climb	MaxTakeoff	15	1 000			
767300	DEFAULT	1	3	Accelerate	MaxTakeoff	15		2 198	152	
767300	DEFAULT	1	4	Accelerate	MaxTakeoff	5		2 198	172	
767300	DEFAULT	1	5	Accelerate	MaxClimb	INT		1 000	215	
767300	DEFAULT	1	6	Accelerate	MaxClimb	ZERO		1 000	235	
767300	DEFAULT	1	7	Climb	MaxClimb	ZERO	3 000			
767300	DEFAULT	1	8	Accelerate	MaxClimb	ZERO		1 000	250	
767300	DEFAULT	1	9	Climb	MaxClimb	ZERO	5 500			
767300	DEFAULT	1	10	Climb	MaxClimb	ZERO	7 500			
767300	DEFAULT	1	11	Climb	MaxClimb	ZERO	10 000			
767300	DEFAULT	2	1	Takeoff	MaxTakeoff	15				
767300	DEFAULT	2	2	Climb	MaxTakeoff	15	1 000			
767300	DEFAULT	2	3	Accelerate	MaxTakeoff	15		2 112	155	
767300	DEFAULT	2	4	Accelerate	MaxTakeoff	5		2 112	175	

ACFTID	Profile_ID	Stage Length	Step Number	Step Type	Thrust Rating	Flap_ID	End Point Altitude (ft)	Rate Of Climb (ft/min)	End Point CAS (kt)	Accelerate_Percent (%)
767300	DEFAULT	2	5	Accelerate	MaxClimb	INT		1 000	218	
767300	DEFAULT	2	6	Accelerate	MaxClimb	ZERO		1 000	238	
767300	DEFAULT	2	7	Climb	MaxClimb	ZERO	3 000			
767300	DEFAULT	2	8	Accelerate	MaxClimb	ZERO		1 000	250	
767300	DEFAULT	2	9	Climb	MaxClimb	ZERO	5 500			
767300	DEFAULT	2	10	Climb	MaxClimb	ZERO	7 500			
767300	DEFAULT	2	11	Climb	MaxClimb	ZERO	10 000			
767300	DEFAULT	3	1	Takeoff	MaxTakeoff	15				
767300	DEFAULT	3	2	Climb	MaxTakeoff	15	1 000			
767300	DEFAULT	3	3	Accelerate	MaxTakeoff	15		2 029	158	
767300	DEFAULT	3	4	Accelerate	MaxTakeoff	5		2 029	178	
767300	DEFAULT	3	5	Accelerate	MaxClimb	INT		1 000	221	
767300	DEFAULT	3	6	Accelerate	MaxClimb	ZERO		1 000	241	
767300	DEFAULT	3	7	Climb	MaxClimb	ZERO	3 000			
767300	DEFAULT	3	8	Accelerate	MaxClimb	ZERO		1 000	250	
767300	DEFAULT	3	9	Climb	MaxClimb	ZERO	5 500			
767300	DEFAULT	3	10	Climb	MaxClimb	ZERO	7 500			
767300	DEFAULT	3	11	Climb	MaxClimb	ZERO	10 000			
767300	DEFAULT	4	1	Takeoff	MaxTakeoff	15				
767300	DEFAULT	4	2	Climb	MaxTakeoff	15	1 000			

ACFTID	Profile_ID	Stage Length	Step Number	Step Type	Thrust Rating	Flap_ID	End Point Altitude (ft)	Rate Of Climb (ft/min)	End Point CAS (kt)	Accelerate_Percent (%)
767300	DEFAULT	4	3	Accelerate	MaxTakeoff	15		1 895	163	
767300	DEFAULT	4	4	Accelerate	MaxTakeoff	5		1 895	183	
767300	DEFAULT	4	5	Accelerate	MaxClimb	INT		1 000	225	
767300	DEFAULT	4	6	Accelerate	MaxClimb	ZERO		1 000	245	
767300	DEFAULT	4	7	Climb	MaxClimb	ZERO	3 000			
767300	DEFAULT	4	8	Accelerate	MaxClimb	ZERO		1 000	250	
767300	DEFAULT	4	9	Climb	MaxClimb	ZERO	5 500			
767300	DEFAULT	4	10	Climb	MaxClimb	ZERO	7 500			
767300	DEFAULT	4	11	Climb	MaxClimb	ZERO	10 000			
767300	DEFAULT	5	1	Takeoff	MaxTakeoff	15				
767300	DEFAULT	5	2	Climb	MaxTakeoff	15	1 000			
767300	DEFAULT	5	3	Accelerate	MaxTakeoff	15		1 744	169	
767300	DEFAULT	5	4	Accelerate	MaxTakeoff	5		1 744	189	
767300	DEFAULT	5	5	Accelerate	MaxClimb	INT		1 000	231	
767300	DEFAULT	5	6	Accelerate	MaxClimb	ZERO		1 000	251	
767300	DEFAULT	5	7	Climb	MaxClimb	ZERO	3 000			
767300	DEFAULT	5	8	Climb	MaxClimb	ZERO	5 500			
767300	DEFAULT	5	9	Climb	MaxClimb	ZERO	7 500			
767300	DEFAULT	5	10	Climb	MaxClimb	ZERO	10 000			
767300	DEFAULT	6	1	Takeoff	MaxTakeoff	15				

ACFTID	Profile_ID	Stage Length	Step Number	Step Type	Thrust Rating	Flap_ID	End Point Altitude (ft)	Rate Of Climb (ft/min)	End Point CAS (kt)	Accelerate_Percent (%)
767300	DEFAULT	6	2	Climb	MaxTakeoff	15	1 000			
767300	DEFAULT	6	3	Accelerate	MaxTakeoff	15		1 602	175	
767300	DEFAULT	6	4	Accelerate	MaxTakeoff	5		1 602	195	
767300	DEFAULT	6	5	Accelerate	MaxClimb	INT		1 000	237	
767300	DEFAULT	6	6	Accelerate	MaxClimb	ZERO		1 000	257	
767300	DEFAULT	6	7	Climb	MaxClimb	ZERO	3 000			
767300	DEFAULT	6	8	Climb	MaxClimb	ZERO	5 500			
767300	DEFAULT	6	9	Climb	MaxClimb	ZERO	7 500			
767300	DEFAULT	6	10	Climb	MaxClimb	ZERO	10 000			
767300	DEFAULT	7	1	Takeoff	MaxTakeoff	15				
767300	DEFAULT	7	2	Climb	MaxTakeoff	15	1 000			
767300	DEFAULT	7	3	Accelerate	MaxTakeoff	15		1 542	178	
767300	DEFAULT	7	4	Accelerate	MaxTakeoff	5		1 542	198	
767300	DEFAULT	7	5	Accelerate	MaxClimb	INT		1 000	240	
767300	DEFAULT	7	6	Accelerate	MaxClimb	ZERO		1 000	260	
767300	DEFAULT	7	7	Climb	MaxClimb	ZERO	3 000			
767300	DEFAULT	7	8	Climb	MaxClimb	ZERO	5 500			
767300	DEFAULT	7	9	Climb	MaxClimb	ZERO	7 500			
767300	DEFAULT	7	10	Climb	MaxClimb	ZERO	10 000			
767400	DEFAULT	1	1	Takeoff	MaxTakeoff	T_20_U				

ACFTID	Profile_ID	Stage Length	Step Number	Step Type	Thrust Rating	Flap_ID	End Point Altitude (ft)	Rate Of Climb (ft/min)	End Point CAS (kt)	Accelerate_Percent (%)
767400	DEFAULT	1	2	Climb	MaxTakeoff	T_20_U	1 000			
767400	DEFAULT	1	3	Accelerate	MaxClimb	T_05_U		1 695,3	215,4	
767400	DEFAULT	1	4	Climb	MaxClimb	T_00_U	3 000			
767400	DEFAULT	1	5	Accelerate	MaxClimb	T_00_U		2 123,3	250	
767400	DEFAULT	1	6	Climb	MaxClimb	T_00_U	5 500			
767400	DEFAULT	1	7	Climb	MaxClimb	T_00_U	7 500			
767400	DEFAULT	1	8	Climb	MaxClimb	T_00_U	10 000			
767400	DEFAULT	2	1	Takeoff	MaxTakeoff	T_20_U				
767400	DEFAULT	2	2	Climb	MaxTakeoff	T_20_U	1 000			
767400	DEFAULT	2	3	Accelerate	MaxClimb	T_05_U		1 648,7	217,9	
767400	DEFAULT	2	4	Climb	MaxClimb	T_00_U	3 000			
767400	DEFAULT	2	5	Accelerate	MaxClimb	T_00_U		2 040,6	250	
767400	DEFAULT	2	6	Climb	MaxClimb	T_00_U	5 500			
767400	DEFAULT	2	7	Climb	MaxClimb	T_00_U	7 500			
767400	DEFAULT	2	8	Climb	MaxClimb	T_00_U	10 000			
767400	DEFAULT	3	1	Takeoff	MaxTakeoff	T_20_U				
767400	DEFAULT	3	2	Climb	MaxTakeoff	T_20_U	1 000			
767400	DEFAULT	3	3	Accelerate	MaxClimb	T_05_U		1 584,9	220,5	
767400	DEFAULT	3	4	Climb	MaxClimb	T_00_U	3 000			
767400	DEFAULT	3	5	Accelerate	MaxClimb	T_00_U		1 953,3	250	

ACFTID	Profile_ID	Stage Length	Step Number	Step Type	Thrust Rating	Flap_ID	End Point Altitude (ft)	Rate Of Climb (ft/min)	End Point CAS (kt)	Accelerate_Percent (%)
767400	DEFAULT	3	6	Climb	MaxClimb	T_00_U	5 500			
767400	DEFAULT	3	7	Climb	MaxClimb	T_00_U	7 500			
767400	DEFAULT	3	8	Climb	MaxClimb	T_00_U	10 000			
767400	DEFAULT	4	1	Takeoff	MaxTakeoff	T_20_U				
767400	DEFAULT	4	2	Climb	MaxTakeoff	T_20_U	1 000			
767400	DEFAULT	4	3	Accelerate	MaxClimb	T_05_U		1 482,5	225,1	
767400	DEFAULT	4	4	Climb	MaxClimb	T_00_U	3 000			
767400	DEFAULT	4	5	Accelerate	MaxClimb	T_00_U		1 821,8	250	
767400	DEFAULT	4	6	Climb	MaxClimb	T_00_U	5 500			
767400	DEFAULT	4	7	Climb	MaxClimb	T_00_U	7 500			
767400	DEFAULT	4	8	Climb	MaxClimb	T_00_U	10 000			
767400	DEFAULT	5	1	Takeoff	MaxTakeoff	T_20_U				
767400	DEFAULT	5	2	Climb	MaxTakeoff	T_20_U	1 000			
767400	DEFAULT	5	3	Accelerate	MaxClimb	T_05_U		1 360,1	230,5	
767400	DEFAULT	5	4	Climb	MaxClimb	T_00_U	3 000			
767400	DEFAULT	5	5	Accelerate	MaxClimb	T_00_U		1 661,5	250	
767400	DEFAULT	5	6	Climb	MaxClimb	T_00_U	5 500			
767400	DEFAULT	5	7	Climb	MaxClimb	T_00_U	7 500			
767400	DEFAULT	5	8	Climb	MaxClimb	T_00_U	10 000			
767400	DEFAULT	6	1	Takeoff	MaxTakeoff	T_20_U				

ACFTID	Profile_ID	Stage Length	Step Number	Step Type	Thrust Rating	Flap_ID	End Point Altitude (ft)	Rate Of Climb (ft/min)	End Point CAS (kt)	Accelerate_Percent (%)
767400	DEFAULT	6	2	Climb	MaxTakeoff	T_20_U	1 000			
767400	DEFAULT	6	3	Accelerate	MaxClimb	T_05_U		1 246,4	236	
767400	DEFAULT	6	4	Climb	MaxClimb	T_00_U	3 000			
767400	DEFAULT	6	5	Accelerate	MaxClimb	T_00_U		1 508	250	
767400	DEFAULT	6	6	Climb	MaxClimb	T_00_U	5 500			
767400	DEFAULT	6	7	Climb	MaxClimb	T_00_U	7 500			
767400	DEFAULT	6	8	Climb	MaxClimb	T_00_U	10 000			
767400	DEFAULT	7	1	Takeoff	MaxTakeoff	T_20_U				
767400	DEFAULT	7	2	Climb	MaxTakeoff	T_20_U	1 000			
767400	DEFAULT	7	3	Accelerate	MaxClimb	T_05_U		1 091,3	244,3	
767400	DEFAULT	7	4	Climb	MaxClimb	T_00_U	3 000			
767400	DEFAULT	7	5	Accelerate	MaxClimb	T_00_U		1 303,8	250	
767400	DEFAULT	7	6	Climb	MaxClimb	T_00_U	5 500			
767400	DEFAULT	7	7	Climb	MaxClimb	T_00_U	7 500			
767400	DEFAULT	7	8	Climb	MaxClimb	T_00_U	10 000			
767400	ICAO_A	1	1	Takeoff	MaxTakeoff	T_20_U				
767400	ICAO_A	1	2	Climb	MaxTakeoff	T_20_U	1 500			
767400	ICAO_A	1	3	Climb	MaxClimb	T_20_U	3 000			
767400	ICAO_A	1	4	Accelerate	MaxClimb	T_05A		1 659,9	215,1	
767400	ICAO_A	1	5	Climb	MaxClimb	T_00_U	4 616			

ACFTID	Profile_ID	Stage Length	Step Number	Step Type	Thrust Rating	Flap_ID	End Point Altitude (ft)	Rate Of Climb (ft/min)	End Point CAS (kt)	Accelerate_Percent (%)
767400	ICAO_A	1	6	Accelerate	MaxClimb	T_00_U		2 098,5	250	
767400	ICAO_A	1	7	Climb	MaxClimb	T_00_U	5 500			
767400	ICAO_A	1	8	Climb	MaxClimb	T_00_U	7 500			
767400	ICAO_A	1	9	Climb	MaxClimb	T_00_U	10 000			
767400	ICAO_A	2	1	Takeoff	MaxTakeoff	T_20_U				
767400	ICAO_A	2	2	Climb	MaxTakeoff	T_20_U	1 500			
767400	ICAO_A	2	3	Climb	MaxClimb	T_20_U	3 000			
767400	ICAO_A	2	4	Accelerate	MaxClimb	T_05A		1 600	217,6	
767400	ICAO_A	2	5	Climb	MaxClimb	T_00_U	4 536			
767400	ICAO_A	2	6	Accelerate	MaxClimb	T_00_U		2 008	250	
767400	ICAO_A	2	7	Climb	MaxClimb	T_00_U	5 500			
767400	ICAO_A	2	8	Climb	MaxClimb	T_00_U	7 500			
767400	ICAO_A	2	9	Climb	MaxClimb	T_00_U	10 000			
767400	ICAO_A	3	1	Takeoff	MaxTakeoff	T_20_U				
767400	ICAO_A	3	2	Climb	MaxTakeoff	T_20_U	1 500			
767400	ICAO_A	3	3	Climb	MaxClimb	T_20_U	3 000			
767400	ICAO_A	3	4	Accelerate	MaxClimb	T_05B		1 536,2	220,4	
767400	ICAO_A	3	5	Climb	MaxClimb	T_00_U	4 454			
767400	ICAO_A	3	6	Accelerate	MaxClimb	T_00_U		1 935,8	250	
767400	ICAO_A	3	7	Climb	MaxClimb	T_00_U	5 500			

ACFTID	Profile_ID	Stage Length	Step Number	Step Type	Thrust Rating	Flap_ID	End Point Altitude (ft)	Rate Of Climb (ft/min)	End Point CAS (kt)	Accelerate_Percent (%)
767400	ICAO_A	3	8	Climb	MaxClimb	T_00_U	7 500			
767400	ICAO_A	3	9	Climb	MaxClimb	T_00_U	10 000			
767400	ICAO_A	4	1	Takeoff	MaxTakeoff	T_20_U				
767400	ICAO_A	4	2	Climb	MaxTakeoff	T_20_U	1 500			
767400	ICAO_A	4	3	Climb	MaxClimb	T_20_U	3 000			
767400	ICAO_A	4	4	Accelerate	MaxClimb	T_05B		1 434,4	224,8	
767400	ICAO_A	4	5	Climb	MaxClimb	T_00_U	4 323			
767400	ICAO_A	4	6	Accelerate	MaxClimb	T_00_U		1 796,6	250	
767400	ICAO_A	4	7	Climb	MaxClimb	T_00_U	5 500			
767400	ICAO_A	4	8	Climb	MaxClimb	T_00_U	7 500			
767400	ICAO_A	4	9	Climb	MaxClimb	T_00_U	10 000			
767400	ICAO_A	5	1	Takeoff	MaxTakeoff	T_20_U				
767400	ICAO_A	5	2	Climb	MaxTakeoff	T_20_U	1 500			
767400	ICAO_A	5	3	Climb	MaxClimb	T_20_U	3 000			
767400	ICAO_A	5	4	Accelerate	MaxClimb	T_05B		1 318,8	230,2	
767400	ICAO_A	5	5	Climb	MaxClimb	T_00_U	4 173			
767400	ICAO_A	5	6	Accelerate	MaxClimb	T_00_U		1 640	250	
767400	ICAO_A	5	7	Climb	MaxClimb	T_00_U	5 500			
767400	ICAO_A	5	8	Climb	MaxClimb	T_00_U	7 500			
767400	ICAO_A	5	9	Climb	MaxClimb	T_00_U	10 000			

ACFTID	Profile_ID	Stage Length	Step Number	Step Type	Thrust Rating	Flap_ID	End Point Altitude (ft)	Rate Of Climb (ft/min)	End Point CAS (kt)	Accelerate_Percent (%)
767400	ICAO_A	6	1	Takeoff	MaxTakeoff	T_20_U				
767400	ICAO_A	6	2	Climb	MaxTakeoff	T_20_U	1 500			
767400	ICAO_A	6	3	Climb	MaxClimb	T_20_U	3 000			
767400	ICAO_A	6	4	Accelerate	MaxClimb	T_05B		1 258,5	250	
767400	ICAO_A	6	5	Climb	MaxClimb	T_00_U	5 500			
767400	ICAO_A	6	6	Climb	MaxClimb	T_00_U	7 500			
767400	ICAO_A	6	7	Climb	MaxClimb	T_00_U	10 000			
767400	ICAO_A	7	1	Takeoff	MaxTakeoff	T_20_U				
767400	ICAO_A	7	2	Climb	MaxTakeoff	T_20_U	1 500			
767400	ICAO_A	7	3	Climb	MaxClimb	T_20_U	3 000			
767400	ICAO_A	7	4	Accelerate	MaxClimb	T_05B		1 073	250	
767400	ICAO_A	7	5	Climb	MaxClimb	T_00_U	5 500			
767400	ICAO_A	7	6	Climb	MaxClimb	T_00_U	7 500			
767400	ICAO_A	7	7	Climb	MaxClimb	T_00_U	10 000			
767400	ICAO_B	1	1	Takeoff	MaxTakeoff	T_20_U				
767400	ICAO_B	1	2	Climb	MaxTakeoff	T_20_U	1 000			
767400	ICAO_B	1	3	Accelerate	MaxTakeoff	T_05_U		2 330,5	215,3	
767400	ICAO_B	1	4	Climb	MaxTakeoff	T_00_U	3 491			
767400	ICAO_B	1	5	Accelerate	MaxClimb	T_00_U		2 147	250	
767400	ICAO_B	1	6	Climb	MaxClimb	T_00_U	5 000			

ACFTID	Profile_ID	Stage Length	Step Number	Step Type	Thrust Rating	Flap_ID	End Point Altitude (ft)	Rate Of Climb (ft/min)	End Point CAS (kt)	Accelerate_Percent (%)
767400	ICAO_B	1	7	Climb	MaxClimb	T_00_U	7 500			
767400	ICAO_B	1	8	Climb	MaxClimb	T_00_U	10 000			
767400	ICAO_B	2	1	Takeoff	MaxTakeoff	T_20_U				
767400	ICAO_B	2	2	Climb	MaxTakeoff	T_20_U	1 000			
767400	ICAO_B	2	3	Accelerate	MaxTakeoff	T_05_U		2 267,2	217,9	
767400	ICAO_B	2	4	Climb	MaxTakeoff	T_00_U	3 393			
767400	ICAO_B	2	5	Accelerate	MaxClimb	T_00_U		2 080,9	250	
767400	ICAO_B	2	6	Climb	MaxClimb	T_00_U	5 000			
767400	ICAO_B	2	7	Climb	MaxClimb	T_00_U	7 500			
767400	ICAO_B	2	8	Climb	MaxClimb	T_00_U	10 000			
767400	ICAO_B	3	1	Takeoff	MaxTakeoff	T_20_U				
767400	ICAO_B	3	2	Climb	MaxTakeoff	T_20_U	1 000			
767400	ICAO_B	3	3	Accelerate	MaxTakeoff	T_05_U		2 183,7	220,6	
767400	ICAO_B	3	4	Climb	MaxTakeoff	T_00_U	3 292			
767400	ICAO_B	3	5	Accelerate	MaxClimb	T_00_U		1 975,7	250	
767400	ICAO_B	3	6	Climb	MaxClimb	T_00_U	5 000			
767400	ICAO_B	3	7	Climb	MaxClimb	T_00_U	7 500			
767400	ICAO_B	3	8	Climb	MaxClimb	T_00_U	10 000			
767400	ICAO_B	4	1	Takeoff	MaxTakeoff	T_20_U				
767400	ICAO_B	4	2	Climb	MaxTakeoff	T_20_U	1 000			

ACFTID	Profile_ID	Stage Length	Step Number	Step Type	Thrust Rating	Flap_ID	End Point Altitude (ft)	Rate Of Climb (ft/min)	End Point CAS (kt)	Accelerate_Percent (%)
767400	ICAO_B	4	3	Accelerate	MaxTakeoff	T_05_U		2 054,4	225	
767400	ICAO_B	4	4	Climb	MaxTakeoff	T_00_U	3 128			
767400	ICAO_B	4	5	Accelerate	MaxClimb	T_00_U		1 850,9	250	
767400	ICAO_B	4	6	Climb	MaxClimb	T_00_U	5 000			
767400	ICAO_B	4	7	Climb	MaxClimb	T_00_U	7 500			
767400	ICAO_B	4	8	Climb	MaxClimb	T_00_U	10 000			
767400	ICAO_B	5	1	Takeoff	MaxTakeoff	T_20_U				
767400	ICAO_B	5	2	Climb	MaxTakeoff	T_20_U	1 000			
767400	ICAO_B	5	3	Accelerate	MaxTakeoff	T_05_U		1 908,2	230,4	
767400	ICAO_B	5	4	Climb	MaxTakeoff	T_00_U	2 944			
767400	ICAO_B	5	5	Climb	MaxClimb	T_00_U	3 000			
767400	ICAO_B	5	6	Accelerate	MaxClimb	T_00_U		1 653,1	250	
767400	ICAO_B	5	7	Climb	MaxClimb	T_00_U	5 000			
767400	ICAO_B	5	8	Climb	MaxClimb	T_00_U	7 500			
767400	ICAO_B	5	9	Climb	MaxClimb	T_00_U	10 000			
767400	ICAO_B	6	1	Takeoff	MaxTakeoff	T_20_U				
767400	ICAO_B	6	2	Climb	MaxTakeoff	T_20_U	1 000			
767400	ICAO_B	6	3	Accelerate	MaxTakeoff	T_05_U		1 771,1	236	
767400	ICAO_B	6	4	Climb	MaxTakeoff	T_00_U	2 766			
767400	ICAO_B	6	5	Climb	MaxClimb	T_00_U	3 000			

ACFTID	Profile_ID	Stage Length	Step Number	Step Type	Thrust Rating	Flap_ID	End Point Altitude (ft)	Rate Of Climb (ft/min)	End Point CAS (kt)	Accelerate_Percent (%)
767400	ICAO_B	6	6	Accelerate	MaxClimb	T_00_U		1 521,4	250	
767400	ICAO_B	6	7	Climb	MaxClimb	T_00_U	5 000			
767400	ICAO_B	6	8	Climb	MaxClimb	T_00_U	7 500			
767400	ICAO_B	6	9	Climb	MaxClimb	T_00_U	10 000			
767400	ICAO_B	7	1	Takeoff	MaxTakeoff	T_20_U				
767400	ICAO_B	7	2	Climb	MaxTakeoff	T_20_U	1 000			
767400	ICAO_B	7	3	Accelerate	MaxTakeoff	T_05_U		1 560,3	239,8	
767400	ICAO_B	7	4	Climb	MaxTakeoff	T_00_U	2 111			
767400	ICAO_B	7	5	Accelerate	MaxTakeoff	T_00_U		1 840	244,3	
767400	ICAO_B	7	6	Climb	MaxTakeoff	T_00_U	2 523			
767400	ICAO_B	7	7	Climb	MaxClimb	T_00_U	3 000			
767400	ICAO_B	7	8	Accelerate	MaxClimb	T_00_U		1 303,8	250	
767400	ICAO_B	7	9	Climb	MaxClimb	T_00_U	5 000			
767400	ICAO_B	7	10	Climb	MaxClimb	T_00_U	7 500			
767400	ICAO_B	7	11	Climb	MaxClimb	T_00_U	10 000			
767CF6	DEFAULT	1	1	Takeoff	MaxTakeoff	15				
767CF6	DEFAULT	1	2	Climb	MaxTakeoff	15	1 000			
767CF6	DEFAULT	1	3	Accelerate	MaxTakeoff	15		1 913	144	
767CF6	DEFAULT	1	4	Accelerate	MaxTakeoff	5		1 913	164	
767CF6	DEFAULT	1	5	Accelerate	MaxClimb	1		1 000	204	

ACFTID	Profile_ID	Stage Length	Step Number	Step Type	Thrust Rating	Flap_ID	End Point Altitude (ft)	Rate Of Climb (ft/min)	End Point CAS (kt)	Accelerate_Percent (%)
767CF6	DEFAULT	1	6	Accelerate	MaxClimb	ZERO		1 000	224	
767CF6	DEFAULT	1	7	Climb	MaxClimb	ZERO	3 000			
767CF6	DEFAULT	1	8	Accelerate	MaxClimb	ZERO		1 000	250	
767CF6	DEFAULT	1	9	Climb	MaxClimb	ZERO	5 500			
767CF6	DEFAULT	1	10	Climb	MaxClimb	ZERO	7 500			
767CF6	DEFAULT	1	11	Climb	MaxClimb	ZERO	10 000			
767CF6	DEFAULT	2	1	Takeoff	MaxTakeoff	15				
767CF6	DEFAULT	2	2	Climb	MaxTakeoff	15	1 000			
767CF6	DEFAULT	2	3	Accelerate	MaxTakeoff	15		1 840	147	
767CF6	DEFAULT	2	4	Accelerate	MaxTakeoff	5		1 840	167	
767CF6	DEFAULT	2	5	Accelerate	MaxClimb	1		1 000	206	
767CF6	DEFAULT	2	6	Accelerate	MaxClimb	ZERO		1 000	226	
767CF6	DEFAULT	2	7	Climb	MaxClimb	ZERO	3 000			
767CF6	DEFAULT	2	8	Accelerate	MaxClimb	ZERO		1 000	250	
767CF6	DEFAULT	2	9	Climb	MaxClimb	ZERO	5 500			
767CF6	DEFAULT	2	10	Climb	MaxClimb	ZERO	7 500			
767CF6	DEFAULT	2	11	Climb	MaxClimb	ZERO	10 000			
767CF6	DEFAULT	3	1	Takeoff	MaxTakeoff	15				
767CF6	DEFAULT	3	2	Climb	MaxTakeoff	15	1 000			
767CF6	DEFAULT	3	3	Accelerate	MaxTakeoff	15		1 769	150	

ACFTID	Profile_ID	Stage Length	Step Number	Step Type	Thrust Rating	Flap_ID	End Point Altitude (ft)	Rate Of Climb (ft/min)	End Point CAS (kt)	Accelerate_Percent (%)
767CF6	DEFAULT	3	4	Accelerate	MaxTakeoff	5		1 769	170	
767CF6	DEFAULT	3	5	Accelerate	MaxClimb	1		1 000	209	
767CF6	DEFAULT	3	6	Accelerate	MaxClimb	ZERO		1 000	229	
767CF6	DEFAULT	3	7	Climb	MaxClimb	ZERO	3 000			
767CF6	DEFAULT	3	8	Accelerate	MaxClimb	ZERO		1 000	250	
767CF6	DEFAULT	3	9	Climb	MaxClimb	ZERO	5 500			
767CF6	DEFAULT	3	10	Climb	MaxClimb	ZERO	7 500			
767CF6	DEFAULT	3	11	Climb	MaxClimb	ZERO	10 000			
767CF6	DEFAULT	4	1	Takeoff	MaxTakeoff	15				
767CF6	DEFAULT	4	2	Climb	MaxTakeoff	15	1 000			
767CF6	DEFAULT	4	3	Accelerate	MaxTakeoff	15		1 656	155	
767CF6	DEFAULT	4	4	Accelerate	MaxTakeoff	5		1 656	175	
767CF6	DEFAULT	4	5	Accelerate	MaxClimb	1		1 000	214	
767CF6	DEFAULT	4	6	Accelerate	MaxClimb	ZERO		1 000	234	
767CF6	DEFAULT	4	7	Climb	MaxClimb	ZERO	3 000			
767CF6	DEFAULT	4	8	Accelerate	MaxClimb	ZERO		1 000	250	
767CF6	DEFAULT	4	9	Climb	MaxClimb	ZERO	5 500			
767CF6	DEFAULT	4	10	Climb	MaxClimb	ZERO	7 500			
767CF6	DEFAULT	4	11	Climb	MaxClimb	ZERO	10 000			
767CF6	DEFAULT	5	1	Takeoff	MaxTakeoff	15				

ACFTID	Profile_ID	Stage Length	Step Number	Step Type	Thrust Rating	Flap_ID	End Point Altitude (ft)	Rate Of Climb (ft/min)	End Point CAS (kt)	Accelerate_Percent (%)
767CF6	DEFAULT	5	2	Climb	MaxTakeoff	15	1 000			
767CF6	DEFAULT	5	3	Accelerate	MaxTakeoff	15		1 529	160	
767CF6	DEFAULT	5	4	Accelerate	MaxTakeoff	5		1 529	180	
767CF6	DEFAULT	5	5	Accelerate	MaxClimb	1		1 000	219	
767CF6	DEFAULT	5	6	Accelerate	MaxClimb	ZERO		1 000	239	
767CF6	DEFAULT	5	7	Climb	MaxClimb	ZERO	3 000			
767CF6	DEFAULT	5	8	Accelerate	MaxClimb	ZERO		1 000	250	
767CF6	DEFAULT	5	9	Climb	MaxClimb	ZERO	5 500			
767CF6	DEFAULT	5	10	Climb	MaxClimb	ZERO	7 500			
767CF6	DEFAULT	5	11	Climb	MaxClimb	ZERO	10 000			
767CF6	DEFAULT	6	1	Takeoff	MaxTakeoff	15				
767CF6	DEFAULT	6	2	Climb	MaxTakeoff	15	1 000			
767CF6	DEFAULT	6	3	Accelerate	MaxTakeoff	15		1 407	166	
767CF6	DEFAULT	6	4	Accelerate	MaxTakeoff	5		1 407	186	
767CF6	DEFAULT	6	5	Accelerate	MaxClimb	1		1 000	225	
767CF6	DEFAULT	6	6	Accelerate	MaxClimb	ZERO		1 000	245	
767CF6	DEFAULT	6	7	Climb	MaxClimb	ZERO	3 000			
767CF6	DEFAULT	6	8	Accelerate	MaxClimb	ZERO		1 000	250	
767CF6	DEFAULT	6	9	Climb	MaxClimb	ZERO	5 500			
767CF6	DEFAULT	6	10	Climb	MaxClimb	ZERO	7 500			

ACFTID	Profile_ID	Stage Length	Step Number	Step Type	Thrust Rating	Flap_ID	End Point Altitude (ft)	Rate Of Climb (ft/min)	End Point CAS (kt)	Accelerate_Percent (%)
767CF6	DEFAULT	6	11	Climb	MaxClimb	ZERO	10 000			
767CF6	DEFAULT	7	1	Takeoff	MaxTakeoff	15				
767CF6	DEFAULT	7	2	Climb	MaxTakeoff	15	1 000			
767CF6	DEFAULT	7	3	Accelerate	MaxTakeoff	15		1 345	169	
767CF6	DEFAULT	7	4	Accelerate	MaxTakeoff	5		1 345	189	
767CF6	DEFAULT	7	5	Accelerate	MaxClimb	1		1 000	228	
767CF6	DEFAULT	7	6	Accelerate	MaxClimb	ZERO		1 000	248	
767CF6	DEFAULT	7	7	Climb	MaxClimb	ZERO	3 000			
767CF6	DEFAULT	7	8	Accelerate	MaxClimb	ZERO		1 000	250	
767CF6	DEFAULT	7	9	Climb	MaxClimb	ZERO	5 500			
767CF6	DEFAULT	7	10	Climb	MaxClimb	ZERO	7 500			
767CF6	DEFAULT	7	11	Climb	MaxClimb	ZERO	10 000			
767JT9	DEFAULT	1	1	Takeoff	MaxTakeoff	15				
767JT9	DEFAULT	1	2	Climb	MaxTakeoff	15	1 000			
767JT9	DEFAULT	1	3	Accelerate	MaxTakeoff	15		1 879	145	
767JT9	DEFAULT	1	4	Accelerate	MaxTakeoff	5		1 879	165	
767JT9	DEFAULT	1	5	Accelerate	MaxClimb	1		1 000	204	
767JT9	DEFAULT	1	6	Accelerate	MaxClimb	ZERO		1 000	224	
767JT9	DEFAULT	1	7	Climb	MaxClimb	ZERO	3 000			
767JT9	DEFAULT	1	8	Accelerate	MaxClimb	ZERO		1 000	250	

ACFTID	Profile_ID	Stage Length	Step Number	Step Type	Thrust Rating	Flap_ID	End Point Altitude (ft)	Rate Of Climb (ft/min)	End Point CAS (kt)	Accelerate_Percent (%)
767JT9	DEFAULT	1	9	Climb	MaxClimb	ZERO	5 500			
767JT9	DEFAULT	1	10	Climb	MaxClimb	ZERO	7 500			
767JT9	DEFAULT	1	11	Climb	MaxClimb	ZERO	10 000			
767JT9	DEFAULT	2	1	Takeoff	MaxTakeoff	15				
767JT9	DEFAULT	2	2	Climb	MaxTakeoff	15	1 000			
767JT9	DEFAULT	2	3	Accelerate	MaxTakeoff	15		1 807	148	
767JT9	DEFAULT	2	4	Accelerate	MaxTakeoff	5		1 807	168	
767JT9	DEFAULT	2	5	Accelerate	MaxClimb	1		1 000	207	
767JT9	DEFAULT	2	6	Accelerate	MaxClimb	ZERO		1 000	227	
767JT9	DEFAULT	2	7	Climb	MaxClimb	ZERO	3 000			
767JT9	DEFAULT	2	8	Accelerate	MaxClimb	ZERO		1 000	250	
767JT9	DEFAULT	2	9	Climb	MaxClimb	ZERO	5 500			
767JT9	DEFAULT	2	10	Climb	MaxClimb	ZERO	7 500			
767JT9	DEFAULT	2	11	Climb	MaxClimb	ZERO	10 000			
767JT9	DEFAULT	3	1	Takeoff	MaxTakeoff	15				
767JT9	DEFAULT	3	2	Climb	MaxTakeoff	15	1 000			
767JT9	DEFAULT	3	3	Accelerate	MaxTakeoff	15		1 738	150	
767JT9	DEFAULT	3	4	Accelerate	MaxTakeoff	5		1 738	170	
767JT9	DEFAULT	3	5	Accelerate	MaxClimb	1		1 000	210	
767JT9	DEFAULT	3	6	Accelerate	MaxClimb	ZERO		1 000	230	

ACFTID	Profile_ID	Stage Length	Step Number	Step Type	Thrust Rating	Flap_ID	End Point Altitude (ft)	Rate Of Climb (ft/min)	End Point CAS (kt)	Accelerate_Percent (%)
767JT9	DEFAULT	3	7	Climb	MaxClimb	ZERO	3 000			
767JT9	DEFAULT	3	8	Accelerate	MaxClimb	ZERO		1 000	250	
767JT9	DEFAULT	3	9	Climb	MaxClimb	ZERO	5 500			
767JT9	DEFAULT	3	10	Climb	MaxClimb	ZERO	7 500			
767JT9	DEFAULT	3	11	Climb	MaxClimb	ZERO	10 000			
767JT9	DEFAULT	4	1	Takeoff	MaxTakeoff	15				
767JT9	DEFAULT	4	2	Climb	MaxTakeoff	15	1 000			
767JT9	DEFAULT	4	3	Accelerate	MaxTakeoff	15		1 626	155	
767JT9	DEFAULT	4	4	Accelerate	MaxTakeoff	5		1 626	175	
767JT9	DEFAULT	4	5	Accelerate	MaxClimb	1		1 000	214	
767JT9	DEFAULT	4	6	Accelerate	MaxClimb	ZERO		1 000	234	
767JT9	DEFAULT	4	7	Climb	MaxClimb	ZERO	3 000			
767JT9	DEFAULT	4	8	Accelerate	MaxClimb	ZERO		1 000	250	
767JT9	DEFAULT	4	9	Climb	MaxClimb	ZERO	5 500			
767JT9	DEFAULT	4	10	Climb	MaxClimb	ZERO	7 500			
767JT9	DEFAULT	4	11	Climb	MaxClimb	ZERO	10 000			
767JT9	DEFAULT	5	1	Takeoff	MaxTakeoff	15				
767JT9	DEFAULT	5	2	Climb	MaxTakeoff	15	1 000			
767JT9	DEFAULT	5	3	Accelerate	MaxTakeoff	15		1 499	161	
767JT9	DEFAULT	5	4	Accelerate	MaxTakeoff	5		1 499	181	

ACFTID	Profile_ID	Stage Length	Step Number	Step Type	Thrust Rating	Flap_ID	End Point Altitude (ft)	Rate Of Climb (ft/min)	End Point CAS (kt)	Accelerate_Percent (%)
767JT9	DEFAULT	5	5	Accelerate	MaxClimb	1		1 000	220	
767JT9	DEFAULT	5	6	Accelerate	MaxClimb	ZERO		1 000	240	
767JT9	DEFAULT	5	7	Climb	MaxClimb	ZERO	3 000			
767JT9	DEFAULT	5	8	Accelerate	MaxClimb	ZERO		1 000	250	
767JT9	DEFAULT	5	9	Climb	MaxClimb	ZERO	5 500			
767JT9	DEFAULT	5	10	Climb	MaxClimb	ZERO	7 500			
767JT9	DEFAULT	5	11	Climb	MaxClimb	ZERO	10 000			
767JT9	DEFAULT	6	1	Takeoff	MaxTakeoff	15				
767JT9	DEFAULT	6	2	Climb	MaxTakeoff	15	1 000			
767JT9	DEFAULT	6	3	Accelerate	MaxTakeoff	15		1 379	167	
767JT9	DEFAULT	6	4	Accelerate	MaxTakeoff	5		1 379	187	
767JT9	DEFAULT	6	5	Accelerate	MaxClimb	1		1 000	226	
767JT9	DEFAULT	6	6	Accelerate	MaxClimb	ZERO		1 000	246	
767JT9	DEFAULT	6	7	Climb	MaxClimb	ZERO	3 000			
767JT9	DEFAULT	6	8	Accelerate	MaxClimb	ZERO		1 000	250	
767JT9	DEFAULT	6	9	Climb	MaxClimb	ZERO	5 500			
767JT9	DEFAULT	6	10	Climb	MaxClimb	ZERO	7 500			
767JT9	DEFAULT	6	11	Climb	MaxClimb	ZERO	10 000			
767JT9	DEFAULT	7	1	Takeoff	MaxTakeoff	15				
767JT9	DEFAULT	7	2	Climb	MaxTakeoff	15	1 000			

ACFTID	Profile_ID	Stage Length	Step Number	Step Type	Thrust Rating	Flap_ID	End Point Altitude (ft)	Rate Of Climb (ft/min)	End Point CAS (kt)	Accelerate_Percent (%)
767JT9	DEFAULT	7	3	Accelerate	MaxTakeoff	15		1 328	170	
767JT9	DEFAULT	7	4	Accelerate	MaxTakeoff	5		1 328	190	
767JT9	DEFAULT	7	5	Accelerate	MaxClimb	1		1 000	228	
767JT9	DEFAULT	7	6	Accelerate	MaxClimb	ZERO		1 000	248	
767JT9	DEFAULT	7	7	Climb	MaxClimb	ZERO	3 000			
767JT9	DEFAULT	7	8	Accelerate	MaxClimb	ZERO		1 000	250	
767JT9	DEFAULT	7	9	Climb	MaxClimb	ZERO	5 500			
767JT9	DEFAULT	7	10	Climb	MaxClimb	ZERO	7 500			
767JT9	DEFAULT	7	11	Climb	MaxClimb	ZERO	10 000			
777200	DEFAULT	1	1	Takeoff	MaxTakeoff	T_05				
777200	DEFAULT	1	2	Climb	MaxTakeoff	T_05C	1 089			
777200	DEFAULT	1	3	Accelerate	MaxClimb	T_01		1 583,4	205,9	
777200	DEFAULT	1	4	Accelerate	MaxClimb	T_00		1 744,7	213,7	
777200	DEFAULT	1	5	Climb	MaxClimb	T_00	3 000			
777200	DEFAULT	1	6	Accelerate	MaxClimb	T_00		1 856,6	250	
777200	DEFAULT	1	7	Climb	MaxClimb	T_00	5 500			
777200	DEFAULT	1	8	Climb	MaxClimb	T_00	7 500			
777200	DEFAULT	1	9	Climb	MaxClimb	T_00	10 000			
777200	DEFAULT	2	1	Takeoff	MaxTakeoff	T_05				
777200	DEFAULT	2	2	Climb	MaxTakeoff	T_05C	1 057			

ACFTID	Profile_ID	Stage Length	Step Number	Step Type	Thrust Rating	Flap_ID	End Point Altitude (ft)	Rate Of Climb (ft/min)	End Point CAS (kt)	Accelerate_Percent (%)
777200	DEFAULT	2	3	Accelerate	MaxClimb	T_01		1 526,8	206,6	
777200	DEFAULT	2	4	Accelerate	MaxClimb	T_00		1 681	215,6	
777200	DEFAULT	2	5	Climb	MaxClimb	T_00	3 000			
777200	DEFAULT	2	6	Accelerate	MaxClimb	T_00		1 791,2	250	
777200	DEFAULT	2	7	Climb	MaxClimb	T_00	5 500			
777200	DEFAULT	2	8	Climb	MaxClimb	T_00	7 500			
777200	DEFAULT	2	9	Climb	MaxClimb	T_00	10 000			
777200	DEFAULT	3	1	Takeoff	MaxTakeoff	T_05				
777200	DEFAULT	3	2	Climb	MaxTakeoff	T_05C	1 022			
777200	DEFAULT	3	3	Accelerate	MaxClimb	T_01		1 468,5	207,3	
777200	DEFAULT	3	4	Accelerate	MaxClimb	T_00		1 618,3	217,7	
777200	DEFAULT	3	5	Climb	MaxClimb	T_00	3 000			
777200	DEFAULT	3	6	Accelerate	MaxClimb	T_00		1 725,7	250	
777200	DEFAULT	3	7	Climb	MaxClimb	T_00	5 500			
777200	DEFAULT	3	8	Climb	MaxClimb	T_00	7 500			
777200	DEFAULT	3	9	Climb	MaxClimb	T_00	10 000			
777200	DEFAULT	4	1	Takeoff	MaxTakeoff	T_05				
777200	DEFAULT	4	2	Climb	MaxTakeoff	T_05C	1 000			
777200	DEFAULT	4	3	Accelerate	MaxClimb	T_01		1 363,3	208,9	
777200	DEFAULT	4	4	Accelerate	MaxClimb	T_00		1 510,5	221,7	

ACFTID	Profile_ID	Stage Length	Step Number	Step Type	Thrust Rating	Flap_ID	End Point Altitude (ft)	Rate Of Climb (ft/min)	End Point CAS (kt)	Accelerate_Percent (%)
777200	DEFAULT	4	5	Climb	MaxClimb	T_00	3 000			
777200	DEFAULT	4	6	Accelerate	MaxClimb	T_00		1 601,3	250	
777200	DEFAULT	4	7	Climb	MaxClimb	T_00	5 500			
777200	DEFAULT	4	8	Climb	MaxClimb	T_00	7 500			
777200	DEFAULT	4	9	Climb	MaxClimb	T_00	10 000			
777200	DEFAULT	5	1	Takeoff	MaxTakeoff	T_05				
777200	DEFAULT	5	2	Climb	MaxTakeoff	T_05C	1 000			
777200	DEFAULT	5	3	Accelerate	MaxClimb	T_01		1 247,5	211	
777200	DEFAULT	5	4	Accelerate	MaxClimb	T_00		1 389,1	225,5	
777200	DEFAULT	5	5	Climb	MaxClimb	T_00	3 000			
777200	DEFAULT	5	6	Accelerate	MaxClimb	T_00		1 467,1	250	
777200	DEFAULT	5	7	Climb	MaxClimb	T_00	5 500			
777200	DEFAULT	5	8	Climb	MaxClimb	T_00	7 500			
777200	DEFAULT	5	9	Climb	MaxClimb	T_00	10 000			
777200	DEFAULT	6	1	Takeoff	MaxTakeoff	T_05				
777200	DEFAULT	6	2	Climb	MaxTakeoff	T_05C	1 000			
777200	DEFAULT	6	3	Accelerate	MaxClimb	T_01		1 136,7	213,4	
777200	DEFAULT	6	4	Accelerate	MaxClimb	T_00		1 275	231,5	
777200	DEFAULT	6	5	Climb	MaxClimb	T_00	3 000			
777200	DEFAULT	6	6	Accelerate	MaxClimb	T_00		1 337,6	250	

ACFTID	Profile_ID	Stage Length	Step Number	Step Type	Thrust Rating	Flap_ID	End Point Altitude (ft)	Rate Of Climb (ft/min)	End Point CAS (kt)	Accelerate_Percent (%)
777200	DEFAULT	6	7	Climb	MaxClimb	T_00	5 500			
777200	DEFAULT	6	8	Climb	MaxClimb	T_00	7 500			
777200	DEFAULT	6	9	Climb	MaxClimb	T_00	10 000			
777200	DEFAULT	7	1	Takeoff	MaxTakeoff	T_05				
777200	DEFAULT	7	2	Climb	MaxTakeoff	T_05C	1 000			
777200	DEFAULT	7	3	Accelerate	MaxClimb	T_01		1 032,4	216,2	
777200	DEFAULT	7	4	Accelerate	MaxClimb	T_00		1 147	228,5	
777200	DEFAULT	7	5	Accelerate	MaxClimb	T_00		1 189,4	236,6	
777200	DEFAULT	7	6	Climb	MaxClimb	T_00	3 000			
777200	DEFAULT	7	7	Accelerate	MaxClimb	T_00		1 215,6	250	
777200	DEFAULT	7	8	Climb	MaxClimb	T_00	5 500			
777200	DEFAULT	7	9	Climb	MaxClimb	T_00	7 500			
777200	DEFAULT	7	10	Climb	MaxClimb	T_00	10 000			
777200	DEFAULT	8	1	Takeoff	MaxTakeoff	T_05				
777200	DEFAULT	8	2	Climb	MaxTakeoff	T_05C	1 000			
777200	DEFAULT	8	3	Accelerate	MaxClimb	T_01		931,9	219,4	
777200	DEFAULT	8	4	Accelerate	MaxClimb	T_00H		1 033,1	232,5	
777200	DEFAULT	8	5	Accelerate	MaxClimb	T_00H		1 088,7	242	
777200	DEFAULT	8	6	Climb	MaxClimb	T_00H	3 000			
777200	DEFAULT	8	7	Accelerate	MaxClimb	T_00H		1 101,5	250	

ACFTID	Profile_ID	Stage Length	Step Number	Step Type	Thrust Rating	Flap_ID	End Point Altitude (ft)	Rate Of Climb (ft/min)	End Point CAS (kt)	Accelerate_Percent (%)
777200	DEFAULT	8	8	Climb	MaxClimb	T_00H	5 500			
777200	DEFAULT	8	9	Climb	MaxClimb	T_00H	7 500			
777200	DEFAULT	8	10	Climb	MaxClimb	T_00H	10 000			
777200	DEFAULT	9	1	Takeoff	MaxTakeoff	T_05				
777200	DEFAULT	9	2	Climb	MaxTakeoff	T_05C	1 000			
777200	DEFAULT	9	3	Accelerate	MaxClimb	T_01		874,9	221,7	
777200	DEFAULT	9	4	Accelerate	MaxClimb	T_00H		969,4	235,4	
777200	DEFAULT	9	5	Accelerate	MaxClimb	T_00H		1 020,2	245,6	
777200	DEFAULT	9	6	Climb	MaxClimb	T_00H	3 000			
777200	DEFAULT	9	7	Accelerate	MaxClimb	T_00H		1 031,1	250	
777200	DEFAULT	9	8	Climb	MaxClimb	T_00H	5 500			
777200	DEFAULT	9	9	Climb	MaxClimb	T_00H	7 500			
777200	DEFAULT	9	10	Climb	MaxClimb	T_00H	10 000			
777200	ICAO_A	1	1	Takeoff	MaxTakeoff	T_05				
777200	ICAO_A	1	2	Climb	MaxTakeoff	T_05C	1 500			
777200	ICAO_A	1	3	Climb	MaxClimb	T_01	3 000			
777200	ICAO_A	1	4	Accelerate	MaxClimb	T_05A		1 504	203,3	
777200	ICAO_A	1	5	Accelerate	MaxClimb	T_01		1 700	213,4	
777200	ICAO_A	1	6	Accelerate	MaxClimb	T_00		1 856,1	250	
777200	ICAO_A	1	7	Climb	MaxClimb	T_00	5 500			

ACFTID	Profile_ID	Stage Length	Step Number	Step Type	Thrust Rating	Flap_ID	End Point Altitude (ft)	Rate Of Climb (ft/min)	End Point CAS (kt)	Accelerate_Percent (%)
777200	ICAO_A	1	8	Climb	MaxClimb	T_00	7 500			
777200	ICAO_A	1	9	Climb	MaxClimb	T_00	10 000			
777200	ICAO_A	2	1	Takeoff	MaxTakeoff	T_05				
777200	ICAO_A	2	2	Climb	MaxTakeoff	T_05C	1 500			
777200	ICAO_A	2	3	Climb	MaxClimb	T_01	3 000			
777200	ICAO_A	2	4	Accelerate	MaxClimb	T_05A		1 451,9	204	
777200	ICAO_A	2	5	Accelerate	MaxClimb	T_01		1 633,4	215,4	
777200	ICAO_A	2	6	Accelerate	MaxClimb	T_00		1 789,9	250	
777200	ICAO_A	2	7	Climb	MaxClimb	T_00	5 500			
777200	ICAO_A	2	8	Climb	MaxClimb	T_00	7 500			
777200	ICAO_A	2	9	Climb	MaxClimb	T_00	10 000			
777200	ICAO_A	3	1	Takeoff	MaxTakeoff	T_05				
777200	ICAO_A	3	2	Climb	MaxTakeoff	T_05C	1 500			
777200	ICAO_A	3	3	Climb	MaxClimb	T_01	3 000			
777200	ICAO_A	3	4	Accelerate	MaxClimb	T_05A		1 395,1	204,9	
777200	ICAO_A	3	5	Accelerate	MaxClimb	T_01		1 575	217,3	
777200	ICAO_A	3	6	Accelerate	MaxClimb	T_00		1 719,4	250	
777200	ICAO_A	3	7	Climb	MaxClimb	T_00	5 500			
777200	ICAO_A	3	8	Climb	MaxClimb	T_00	7 500			
777200	ICAO_A	3	9	Climb	MaxClimb	T_00	10 000			

ACFTID	Profile_ID	Stage Length	Step Number	Step Type	Thrust Rating	Flap_ID	End Point Altitude (ft)	Rate Of Climb (ft/min)	End Point CAS (kt)	Accelerate_Percent (%)
777200	ICAO_A	4	1	Takeoff	MaxTakeoff	T_05				
777200	ICAO_A	4	2	Climb	MaxTakeoff	T_05C	1 500			
777200	ICAO_A	4	3	Climb	MaxClimb	T_01	3 000			
777200	ICAO_A	4	4	Accelerate	MaxClimb	T_05A		1 295,2	206,6	
777200	ICAO_A	4	5	Accelerate	MaxClimb	T_01		1 477,7	221,3	
777200	ICAO_A	4	6	Accelerate	MaxClimb	T_00		1 592,4	250	
777200	ICAO_A	4	7	Climb	MaxClimb	T_00	5 500			
777200	ICAO_A	4	8	Climb	MaxClimb	T_00	7 500			
777200	ICAO_A	4	9	Climb	MaxClimb	T_00	10 000			
777200	ICAO_A	5	1	Takeoff	MaxTakeoff	T_05				
777200	ICAO_A	5	2	Climb	MaxTakeoff	T_05C	1 500			
777200	ICAO_A	5	3	Climb	MaxClimb	T_01	3 000			
777200	ICAO_A	5	4	Accelerate	MaxClimb	T_05A		1 182,6	208,8	
777200	ICAO_A	5	5	Accelerate	MaxClimb	T_01		1 346,3	222,1	
777200	ICAO_A	5	6	Accelerate	MaxClimb	T_00		1 451,1	250	
777200	ICAO_A	5	7	Climb	MaxClimb	T_00	5 500			
777200	ICAO_A	5	8	Climb	MaxClimb	T_00	7 500			
777200	ICAO_A	5	9	Climb	MaxClimb	T_00	10 000			
777200	ICAO_A	6	1	Takeoff	MaxTakeoff	T_05				
777200	ICAO_A	6	2	Climb	MaxTakeoff	T_05C	1 500			

ACFTID	Profile_ID	Stage Length	Step Number	Step Type	Thrust Rating	Flap_ID	End Point Altitude (ft)	Rate Of Climb (ft/min)	End Point CAS (kt)	Accelerate_Percent (%)
777200	ICAO_A	6	3	Climb	MaxClimb	T_01	3 000			
777200	ICAO_A	6	4	Accelerate	MaxClimb	T_05		1 075,6	211,4	
777200	ICAO_A	6	5	Accelerate	MaxClimb	T_01		1 217,4	223,4	
777200	ICAO_A	6	6	Accelerate	MaxClimb	T_00		1 316,4	250	
777200	ICAO_A	6	7	Climb	MaxClimb	T_00	5 500			
777200	ICAO_A	6	8	Climb	MaxClimb	T_00	7 500			
777200	ICAO_A	6	9	Climb	MaxClimb	T_00	10 000			
777200	ICAO_A	7	1	Takeoff	MaxTakeoff	T_05				
777200	ICAO_A	7	2	Climb	MaxTakeoff	T_05C	1 500			
777200	ICAO_A	7	3	Climb	MaxClimb	T_01	3 000			
777200	ICAO_A	7	4	Accelerate	MaxClimb	T_05		973,3	214,3	
777200	ICAO_A	7	5	Accelerate	MaxClimb	T_01		1 104,3	227,2	
777200	ICAO_A	7	6	Accelerate	MaxClimb	T_00		1 188,2	250	
777200	ICAO_A	7	7	Climb	MaxClimb	T_00	5 500			
777200	ICAO_A	7	8	Climb	MaxClimb	T_00	7 500			
777200	ICAO_A	7	9	Climb	MaxClimb	T_00	10 000			
777200	ICAO_A	8	1	Takeoff	MaxTakeoff	T_05				
777200	ICAO_A	8	2	Climb	MaxTakeoff	T_05CH	1 500			
777200	ICAO_A	8	3	Climb	MaxClimb	T_01	3 000			
777200	ICAO_A	8	4	Accelerate	MaxClimb	T_05		877,9	217,6	

ACFTID	Profile_ID	Stage Length	Step Number	Step Type	Thrust Rating	Flap_ID	End Point Altitude (ft)	Rate Of Climb (ft/min)	End Point CAS (kt)	Accelerate_Percent (%)
777200	ICAO_A	8	5	Accelerate	MaxClimb	T_01		997,4	231,4	
777200	ICAO_A	8	6	Accelerate	MaxClimb	T_00H		1 071,6	250	
777200	ICAO_A	8	7	Climb	MaxClimb	T_00H	5 500			
777200	ICAO_A	8	8	Climb	MaxClimb	T_00H	7 500			
777200	ICAO_A	8	9	Climb	MaxClimb	T_00H	10 000			
777200	ICAO_A	9	1	Takeoff	MaxTakeoff	T_05				
777200	ICAO_A	9	2	Climb	MaxTakeoff	T_05CH	1 500			
777200	ICAO_A	9	3	Climb	MaxClimb	T_05	3 000			
777200	ICAO_A	9	4	Accelerate	MaxClimb	T_05		820,9	220	
777200	ICAO_A	9	5	Accelerate	MaxClimb	T_01		930,3	234,3	
777200	ICAO_A	9	6	Accelerate	MaxClimb	T_00H		1 000	250	
777200	ICAO_A	9	7	Climb	MaxClimb	T_00H	5 500			
777200	ICAO_A	9	8	Climb	MaxClimb	T_00	7 500			
777200	ICAO_A	9	9	Climb	MaxClimb	T_00	10 000			
777200	ICAO_B	1	1	Takeoff	MaxTakeoff	T_05				
777200	ICAO_B	1	2	Climb	MaxTakeoff	T_05C	1 089			
777200	ICAO_B	1	3	Accelerate	MaxTakeoff	T_05A		2 183,5	193,8	
777200	ICAO_B	1	4	Accelerate	MaxTakeoff	T_01		1 783,1	213,6	
777200	ICAO_B	1	5	Climb	MaxClimb	T_00	3 000			
777200	ICAO_B	1	6	Accelerate	MaxClimb	T_00		1 857,4	250	

ACFTID	Profile_ID	Stage Length	Step Number	Step Type	Thrust Rating	Flap_ID	End Point Altitude (ft)	Rate Of Climb (ft/min)	End Point CAS (kt)	Accelerate_Percent (%)
777200	ICAO_B	1	7	Climb	MaxClimb	T_00	5 500			
777200	ICAO_B	1	8	Climb	MaxClimb	T_00	7 500			
777200	ICAO_B	1	9	Climb	MaxClimb	T_00	10 000			
777200	ICAO_B	2	1	Takeoff	MaxTakeoff	T_05				
777200	ICAO_B	2	2	Climb	MaxTakeoff	T_05C	1 057			
777200	ICAO_B	2	3	Accelerate	MaxTakeoff	T_05A		2 121,3	195,8	
777200	ICAO_B	2	4	Accelerate	MaxTakeoff	T_01		1 722,3	215,5	
777200	ICAO_B	2	5	Climb	MaxClimb	T_00	3 000			
777200	ICAO_B	2	6	Accelerate	MaxClimb	T_00		1 789,8	250	
777200	ICAO_B	2	7	Climb	MaxClimb	T_00	5 500			
777200	ICAO_B	2	8	Climb	MaxClimb	T_00	7 500			
777200	ICAO_B	2	9	Climb	MaxClimb	T_00	10 000			
777200	ICAO_B	3	1	Takeoff	MaxTakeoff	T_05				
777200	ICAO_B	3	2	Climb	MaxTakeoff	T_05C	1 022			
777200	ICAO_B	3	3	Accelerate	MaxTakeoff	T_05A		2 059,4	197,9	
777200	ICAO_B	3	4	Accelerate	MaxTakeoff	T_01		1 664,2	217,6	
777200	ICAO_B	3	5	Climb	MaxClimb	T_00	3 000			
777200	ICAO_B	3	6	Accelerate	MaxClimb	T_00		1 723	250	
777200	ICAO_B	3	7	Climb	MaxClimb	T_00	5 500			
777200	ICAO_B	3	8	Climb	MaxClimb	T_00	7 500			

ACFTID	Profile_ID	Stage Length	Step Number	Step Type	Thrust Rating	Flap_ID	End Point Altitude (ft)	Rate Of Climb (ft/min)	End Point CAS (kt)	Accelerate_Percent (%)
777200	ICAO_B	3	9	Climb	MaxClimb	T_00	10 000			
777200	ICAO_B	4	1	Takeoff	MaxTakeoff	T_05				
777200	ICAO_B	4	2	Climb	MaxTakeoff	T_05C	1 000			
777200	ICAO_B	4	3	Accelerate	MaxTakeoff	T_05A		1 940,1	201,8	
777200	ICAO_B	4	4	Accelerate	MaxTakeoff	T_01		1 555,7	221,6	
777200	ICAO_B	4	5	Climb	MaxClimb	T_00	3 000			
777200	ICAO_B	4	6	Accelerate	MaxClimb	T_00		1 602,1	250	
777200	ICAO_B	4	7	Climb	MaxClimb	T_00	5 500			
777200	ICAO_B	4	8	Climb	MaxClimb	T_00	7 500			
777200	ICAO_B	4	9	Climb	MaxClimb	T_00	10 000			
777200	ICAO_B	5	1	Takeoff	MaxTakeoff	T_05				
777200	ICAO_B	5	2	Climb	MaxTakeoff	T_05C	1 000			
777200	ICAO_B	5	3	Accelerate	MaxTakeoff	T_05A		1 809,2	206,7	
777200	ICAO_B	5	4	Accelerate	MaxTakeoff	T_01		1 431,6	226,5	
777200	ICAO_B	5	5	Climb	MaxClimb	T_00	3 000			
777200	ICAO_B	5	6	Accelerate	MaxClimb	T_00		1 466,4	250	
777200	ICAO_B	5	7	Climb	MaxClimb	T_00	5 500			
777200	ICAO_B	5	8	Climb	MaxClimb	T_00	7 500			
777200	ICAO_B	5	9	Climb	MaxClimb	T_00	10 000			
777200	ICAO_B	6	1	Takeoff	MaxTakeoff	T_05				

ACFTID	Profile_ID	Stage Length	Step Number	Step Type	Thrust Rating	Flap_ID	End Point Altitude (ft)	Rate Of Climb (ft/min)	End Point CAS (kt)	Accelerate_Percent (%)
777200	ICAO_B	6	2	Climb	MaxTakeoff	T_05C	1 000			
777200	ICAO_B	6	3	Accelerate	MaxTakeoff	T_05A		1 683,9	211,6	
777200	ICAO_B	6	4	Accelerate	MaxTakeoff	T_01		1 315,7	231,4	
777200	ICAO_B	6	5	Climb	MaxClimb	T_00	3 000			
777200	ICAO_B	6	6	Accelerate	MaxClimb	T_00		1 337,6	250	
777200	ICAO_B	6	7	Climb	MaxClimb	T_00	5 500			
777200	ICAO_B	6	8	Climb	MaxClimb	T_00	7 500			
777200	ICAO_B	6	9	Climb	MaxClimb	T_00	10 000			
777200	ICAO_B	7	1	Takeoff	MaxTakeoff	T_05				
777200	ICAO_B	7	2	Climb	MaxTakeoff	T_05C	1 000			
777200	ICAO_B	7	3	Accelerate	MaxTakeoff	T_05A		1 562,2	216,6	
777200	ICAO_B	7	4	Accelerate	MaxTakeoff	T_01		1 197,4	236,5	
777200	ICAO_B	7	5	Climb	MaxClimb	T_00	3 000			
777200	ICAO_B	7	6	Accelerate	MaxClimb	T_00		1 214,8	250	
777200	ICAO_B	7	7	Climb	MaxClimb	T_00	5 500			
777200	ICAO_B	7	8	Climb	MaxClimb	T_00	7 500			
777200	ICAO_B	7	9	Climb	MaxClimb	T_00	10 000			
777200	ICAO_B	8	1	Takeoff	MaxTakeoff	T_05				
777200	ICAO_B	8	2	Climb	MaxTakeoff	T_05C	1 000			
777200	ICAO_B	8	3	Accelerate	MaxTakeoff	T_05A		1 450,3	222,2	

ACFTID	Profile_ID	Stage Length	Step Number	Step Type	Thrust Rating	Flap_ID	End Point Altitude (ft)	Rate Of Climb (ft/min)	End Point CAS (kt)	Accelerate_Percent (%)
777200	ICAO_B	8	4	Accelerate	MaxTakeoff	T_01		1 090,6	241,9	
777200	ICAO_B	8	5	Climb	MaxClimb	T_00	3 000			
777200	ICAO_B	8	6	Accelerate	MaxClimb	T_00		1 101,5	250	
777200	ICAO_B	8	7	Climb	MaxClimb	T_00	5 500			
777200	ICAO_B	8	8	Climb	MaxClimb	T_00	7 500			
777200	ICAO_B	8	9	Climb	MaxClimb	T_00	10 000			
777200	ICAO_B	9	1	Takeoff	MaxTakeoff	T_05				
777200	ICAO_B	9	2	Climb	MaxTakeoff	T_05C	1 000			
777200	ICAO_B	9	3	Accelerate	MaxTakeoff	T_05A		1 381,9	225,8	
777200	ICAO_B	9	4	Accelerate	MaxTakeoff	T_01		1 025,7	245,6	
777200	ICAO_B	9	5	Climb	MaxClimb	T_00	3 000			
777200	ICAO_B	9	6	Accelerate	MaxClimb	T_00		1 031,1	250	
777200	ICAO_B	9	7	Climb	MaxClimb	T_00	5 500			
777200	ICAO_B	9	8	Climb	MaxClimb	T_00	7 500			
777200	ICAO_B	9	9	Climb	MaxClimb	T_00	10 000			
777300	DEFAULT	1	1	Takeoff	MaxTakeoff	T_20_U				
777300	DEFAULT	1	2	Climb	MaxTakeoff	T_20_U	1 068			
777300	DEFAULT	1	3	Accelerate	MaxClimb	T_05_U		1 471,6	215,4	
777300	DEFAULT	1	4	Climb	MaxClimb	T_00_U	3 000			
777300	DEFAULT	1	5	Accelerate	MaxClimb	T_00_U		1 779,1	250	

ACFTID	Profile_ID	Stage Length	Step Number	Step Type	Thrust Rating	Flap_ID	End Point Altitude (ft)	Rate Of Climb (ft/min)	End Point CAS (kt)	Accelerate_Percent (%)
777300	DEFAULT	1	6	Climb	MaxClimb	T_00_U	5 000			
777300	DEFAULT	1	7	Climb	MaxClimb	T_00_U	7 500			
777300	DEFAULT	1	8	Climb	MaxClimb	T_00_U	10 000			
777300	DEFAULT	2	1	Takeoff	MaxTakeoff	T_20_U				
777300	DEFAULT	2	2	Climb	MaxTakeoff	T_20_U	1 064			
777300	DEFAULT	2	3	Accelerate	MaxClimb	T_05_U		1 418	217,8	
777300	DEFAULT	2	4	Climb	MaxClimb	T_00_U	3 000			
777300	DEFAULT	2	5	Accelerate	MaxClimb	T_00_U		1 713,9	250	
777300	DEFAULT	2	6	Climb	MaxClimb	T_00_U	5 000			
777300	DEFAULT	2	7	Climb	MaxClimb	T_00_U	7 500			
777300	DEFAULT	2	8	Climb	MaxClimb	T_00_U	10 000			
777300	DEFAULT	3	1	Takeoff	MaxTakeoff	T_20_U				
777300	DEFAULT	3	2	Climb	MaxTakeoff	T_20_U	1 062			
777300	DEFAULT	3	3	Accelerate	MaxClimb	T_05_U		1 368	220,3	
777300	DEFAULT	3	4	Climb	MaxClimb	T_00_U	3 000			
777300	DEFAULT	3	5	Accelerate	MaxClimb	T_00_U		1 638,9	250	
777300	DEFAULT	3	6	Climb	MaxClimb	T_00_U	5 000			
777300	DEFAULT	3	7	Climb	MaxClimb	T_00_U	7 500			
777300	DEFAULT	3	8	Climb	MaxClimb	T_00_U	10 000			
777300	DEFAULT	4	1	Takeoff	MaxTakeoff	T_20_U				

ACFTID	Profile_ID	Stage Length	Step Number	Step Type	Thrust Rating	Flap_ID	End Point Altitude (ft)	Rate Of Climb (ft/min)	End Point CAS (kt)	Accelerate_Percent (%)
777300	DEFAULT	4	2	Climb	MaxTakeoff	T_20_U	1 058			
777300	DEFAULT	4	3	Accelerate	MaxClimb	T_05_U		1 279	224,3	
777300	DEFAULT	4	4	Climb	MaxClimb	T_00_U	3 000			
777300	DEFAULT	4	5	Accelerate	MaxClimb	T_00_U		1 519,4	250	
777300	DEFAULT	4	6	Climb	MaxClimb	T_00_U	5 000			
777300	DEFAULT	4	7	Climb	MaxClimb	T_00_U	7 500			
777300	DEFAULT	4	8	Climb	MaxClimb	T_00_U	10 000			
777300	DEFAULT	5	1	Takeoff	MaxTakeoff	T_20_U				
777300	DEFAULT	5	2	Climb	MaxTakeoff	T_20_U	1 053			
777300	DEFAULT	5	3	Accelerate	MaxClimb	T_05_U		1 179,2	229,4	
777300	DEFAULT	5	4	Climb	MaxClimb	T_00_U	3 000			
777300	DEFAULT	5	5	Accelerate	MaxClimb	T_00_U		1 392,1	250	
777300	DEFAULT	5	6	Climb	MaxClimb	T_00_U	5 000			
777300	DEFAULT	5	7	Climb	MaxClimb	T_00_U	7 500			
777300	DEFAULT	5	8	Climb	MaxClimb	T_00_U	10 000			
777300	DEFAULT	6	1	Takeoff	MaxTakeoff	T_20_U				
777300	DEFAULT	6	2	Climb	MaxTakeoff	T_20_U	1 049			
777300	DEFAULT	6	3	Accelerate	MaxClimb	T_05_U		1 082,8	234,4	
777300	DEFAULT	6	4	Climb	MaxClimb	T_00_U	3 000			
777300	DEFAULT	6	5	Accelerate	MaxClimb	T_00_U		1 260	250	

ACFTID	Profile_ID	Stage Length	Step Number	Step Type	Thrust Rating	Flap_ID	End Point Altitude (ft)	Rate Of Climb (ft/min)	End Point CAS (kt)	Accelerate_Percent (%)
777300	DEFAULT	6	6	Climb	MaxClimb	T_00_U	5 000			
777300	DEFAULT	6	7	Climb	MaxClimb	T_00_U	7 500			
777300	DEFAULT	6	8	Climb	MaxClimb	T_00_U	10 000			
777300	DEFAULT	7	1	Takeoff	MaxTakeoff	T_20_U				
777300	DEFAULT	7	2	Climb	MaxTakeoff	T_20_U	1 042			
777300	DEFAULT	7	3	Accelerate	MaxClimb	T_05_U		911,6	243,4	
777300	DEFAULT	7	4	Climb	MaxClimb	T_00_U	3 000			
777300	DEFAULT	7	5	Accelerate	MaxClimb	T_00_U		1 060,3	250	
777300	DEFAULT	7	6	Climb	MaxClimb	T_00_U	5 000			
777300	DEFAULT	7	7	Climb	MaxClimb	T_00_U	7 500			
777300	DEFAULT	7	8	Climb	MaxClimb	T_00_U	10 000			
777300	ICAO_A	1	1	Takeoff	MaxTakeoff	T_20_U				
777300	ICAO_A	1	2	Climb	MaxTakeoff	T_20_U	1 565			
777300	ICAO_A	1	3	Climb	MaxClimb	T_20_U	3 000			
777300	ICAO_A	1	4	Accelerate	MaxClimb	T_05_U		1 420,7	215,2	
777300	ICAO_A	1	5	Climb	MaxClimb	T_00_U	4 117			
777300	ICAO_A	1	6	Accelerate	MaxClimb	T_00_U		1 762,5	250	
777300	ICAO_A	1	7	Climb	MaxClimb	T_00_U	5 000			
777300	ICAO_A	1	8	Climb	MaxClimb	T_00_U	7 500			
777300	ICAO_A	1	9	Climb	MaxClimb	T_00_U	10 000			

ACFTID	Profile_ID	Stage Length	Step Number	Step Type	Thrust Rating	Flap_ID	End Point Altitude (ft)	Rate Of Climb (ft/min)	End Point CAS (kt)	Accelerate_Percent (%)
777300	ICAO_A	2	1	Takeoff	MaxTakeoff	T_20_U				
777300	ICAO_A	2	2	Climb	MaxTakeoff	T_20_U	1 563			
777300	ICAO_A	2	3	Climb	MaxClimb	T_20_U	3 000			
777300	ICAO_A	2	4	Accelerate	MaxClimb	T_05_U		1 372,5	217,6	
777300	ICAO_A	2	5	Climb	MaxClimb	T_00_U	4 014			
777300	ICAO_A	2	6	Accelerate	MaxClimb	T_00_U		1 691,8	250	
777300	ICAO_A	2	7	Climb	MaxClimb	T_00_U	5 000			
777300	ICAO_A	2	8	Climb	MaxClimb	T_00_U	7 500			
777300	ICAO_A	2	9	Climb	MaxClimb	T_00_U	10 000			
777300	ICAO_A	3	1	Takeoff	MaxTakeoff	T_20_U				
777300	ICAO_A	3	2	Climb	MaxTakeoff	T_20_U	1 561			
777300	ICAO_A	3	3	Climb	MaxClimb	T_20_U	3 000			
777300	ICAO_A	3	4	Accelerate	MaxClimb	T_05_U		1 320,6	220	
777300	ICAO_A	3	5	Climb	MaxClimb	T_00_U	4 041			
777300	ICAO_A	3	6	Accelerate	MaxClimb	T_00_U		1 616	250	
777300	ICAO_A	3	7	Climb	MaxClimb	T_00_U	5 000			
777300	ICAO_A	3	8	Climb	MaxClimb	T_00_U	7 500			
777300	ICAO_A	3	9	Climb	MaxClimb	T_00_U	10 000			
777300	ICAO_A	4	1	Takeoff	MaxTakeoff	T_20_U				
777300	ICAO_A	4	2	Climb	MaxTakeoff	T_20_U	1 557			

ACFTID	Profile_ID	Stage Length	Step Number	Step Type	Thrust Rating	Flap_ID	End Point Altitude (ft)	Rate Of Climb (ft/min)	End Point CAS (kt)	Accelerate_Percent (%)
777300	ICAO_A	4	3	Climb	MaxClimb	T_20_U	3 000			
777300	ICAO_A	4	4	Accelerate	MaxClimb	T_00_U		1 320,5	250	
777300	ICAO_A	4	5	Climb	MaxClimb	T_00_U	5 000			
777300	ICAO_A	4	6	Climb	MaxClimb	T_00_U	7 500			
777300	ICAO_A	4	7	Climb	MaxClimb	T_00_U	10 000			
777300	ICAO_A	5	1	Takeoff	MaxTakeoff	T_05_U				
777300	ICAO_A	5	2	Climb	MaxTakeoff	T_20_U	1 553			
777300	ICAO_A	5	3	Climb	MaxClimb	T_20_U	3 000			
777300	ICAO_A	5	4	Accelerate	MaxClimb	T_00_U		1 199,1	250	
777300	ICAO_A	5	5	Climb	MaxClimb	T_00_U	5 000			
777300	ICAO_A	5	6	Climb	MaxClimb	T_00_U	7 500			
777300	ICAO_A	5	7	Climb	MaxClimb	T_00_U	10 000			
777300	ICAO_A	6	1	Takeoff	MaxTakeoff	T_20_U				
777300	ICAO_A	6	2	Climb	MaxTakeoff	T_20_U	1 553			
777300	ICAO_A	6	3	Climb	MaxClimb	T_20_U	3 000			
777300	ICAO_A	6	4	Accelerate	MaxClimb	T_00_U		1 083,7	250	
777300	ICAO_A	6	5	Climb	MaxClimb	T_00_U	5 000			
777300	ICAO_A	6	6	Climb	MaxClimb	T_00_U	7 500			
777300	ICAO_A	6	7	Climb	MaxClimb	T_00_U	10 000			
777300	ICAO_A	7	1	Takeoff	MaxTakeoff	T_20_U				

ACFTID	Profile_ID	Stage Length	Step Number	Step Type	Thrust Rating	Flap_ID	End Point Altitude (ft)	Rate Of Climb (ft/min)	End Point CAS (kt)	Accelerate_Percent (%)
777300	ICAO_A	7	2	Climb	MaxTakeoff	T_20_U	1 553			
777300	ICAO_A	7	3	Climb	MaxClimb	T_20_U	3 000			
777300	ICAO_A	7	4	Accelerate	MaxClimb	T_00_U		889	250	
777300	ICAO_A	7	5	Climb	MaxClimb	T_00_U	5 000			
777300	ICAO_A	7	6	Climb	MaxClimb	T_00_U	7 500			
777300	ICAO_A	7	7	Climb	MaxClimb	T_00_U	10 000			
777300	ICAO_B	1	1	Takeoff	MaxTakeoff	T_20_U				
777300	ICAO_B	1	2	Climb	MaxTakeoff	T_20_U	1 000			
777300	ICAO_B	1	3	Accelerate	MaxTakeoff	T_05_U		2 149,6	215,4	
777300	ICAO_B	1	4	Climb	MaxTakeoff	T_00_U	3 416			
777300	ICAO_B	1	5	Accelerate	MaxClimb	T_00_U		1 800	250	
777300	ICAO_B	1	6	Climb	MaxClimb	T_00_U	5 000			
777300	ICAO_B	1	7	Climb	MaxClimb	T_00_U	7 500			
777300	ICAO_B	1	8	Climb	MaxClimb	T_00_U	10 000			
777300	ICAO_B	2	1	Takeoff	MaxTakeoff	T_20_U				
777300	ICAO_B	2	2	Climb	MaxTakeoff	T_20_U	1 000			
777300	ICAO_B	2	3	Accelerate	MaxTakeoff	T_05_U		2 086,3	217,9	
777300	ICAO_B	2	4	Climb	MaxTakeoff	T_00_U	3 205			
777300	ICAO_B	2	5	Accelerate	MaxClimb	T_00_U		1 772,6	250	
777300	ICAO_B	2	6	Climb	MaxClimb	T_00_U	5 000			

ACFTID	Profile_ID	Stage Length	Step Number	Step Type	Thrust Rating	Flap_ID	End Point Altitude (ft)	Rate Of Climb (ft/min)	End Point CAS (kt)	Accelerate_Percent (%)
777300	ICAO_B	2	7	Climb	MaxClimb	T_00_U	7 500			
777300	ICAO_B	2	8	Climb	MaxClimb	T_00_U	10 000			
777300	ICAO_B	3	1	Takeoff	MaxTakeoff	T_20_U				
777300	ICAO_B	3	2	Climb	MaxTakeoff	T_20_U	1 000			
777300	ICAO_B	3	3	Accelerate	MaxTakeoff	T_05_U		2 020,6	220,3	
777300	ICAO_B	3	4	Climb	MaxTakeoff	T_00_U	3 076			
777300	ICAO_B	3	5	Accelerate	MaxClimb	T_00_U		1 708,6	250	
777300	ICAO_B	3	6	Climb	MaxClimb	T_00_U	5 000			
777300	ICAO_B	3	7	Climb	MaxClimb	T_00_U	7 500			
777300	ICAO_B	3	8	Climb	MaxClimb	T_00_U	10 000			
777300	ICAO_B	4	1	Takeoff	MaxTakeoff	T_20_U				
777300	ICAO_B	4	2	Climb	MaxTakeoff	T_20_U	1 000			
777300	ICAO_B	4	3	Accelerate	MaxTakeoff	T_05_U		1 895,3	226,3	
777300	ICAO_B	4	4	Climb	MaxTakeoff	T_00_U	2 894			
777300	ICAO_B	4	5	Climb	MaxClimb	T_00_U	3 000			
777300	ICAO_B	4	6	Accelerate	MaxClimb	T_00_U		1 525,8	250	
777300	ICAO_B	4	7	Climb	MaxClimb	T_00_U	5 000			
777300	ICAO_B	4	8	Climb	MaxClimb	T_00_U	7 500			
777300	ICAO_B	4	9	Climb	MaxClimb	T_00_U	10 000			
777300	ICAO_B	5	1	Takeoff	MaxTakeoff	T_20_U				

ACFTID	Profile_ID	Stage Length	Step Number	Step Type	Thrust Rating	Flap_ID	End Point Altitude (ft)	Rate Of Climb (ft/min)	End Point CAS (kt)	Accelerate_Percent (%)
777300	ICAO_B	5	2	Climb	MaxTakeoff	T_20_U	1 000			
777300	ICAO_B	5	3	Accelerate	MaxTakeoff	T_05_U		1 768,6	229,4	
777300	ICAO_B	5	4	Climb	MaxTakeoff	T_00_U	2 679			
777300	ICAO_B	5	5	Climb	MaxClimb	T_00_U	3 000			
777300	ICAO_B	5	6	Accelerate	MaxClimb	T_00_U		1 387,7	250	
777300	ICAO_B	5	7	Climb	MaxClimb	T_00_U	5 000			
777300	ICAO_B	5	8	Climb	MaxClimb	T_00_U	7 500			
777300	ICAO_B	5	9	Climb	MaxClimb	T_00_U	10 000			
777300	ICAO_B	6	1	Takeoff	MaxTakeoff	T_20_U				
777300	ICAO_B	6	2	Climb	MaxTakeoff	T_20_U	1 000			
777300	ICAO_B	6	3	Accelerate	MaxTakeoff	T_05_U		1 639,4	235,5	
777300	ICAO_B	6	4	Climb	MaxTakeoff	T_00_U	2 402			
777300	ICAO_B	6	5	Climb	MaxClimb	T_00_U	3 000			
777300	ICAO_B	6	6	Accelerate	MaxClimb	T_00_U		1 271,6	250	
777300	ICAO_B	6	7	Climb	MaxClimb	T_00_U	5 000			
777300	ICAO_B	6	8	Climb	MaxClimb	T_00_U	7 500			
777300	ICAO_B	6	9	Climb	MaxClimb	T_00_U	10 000			
777300	ICAO_B	7	1	Takeoff	MaxTakeoff	T_20_U				
777300	ICAO_B	7	2	Climb	MaxTakeoff	T_20_U	1 000			
777300	ICAO_B	7	3	Accelerate	MaxTakeoff	T_05_U		1 491	244,4	

ACFTID	Profile_ID	Stage Length	Step Number	Step Type	Thrust Rating	Flap_ID	End Point Altitude (ft)	Rate Of Climb (ft/min)	End Point CAS (kt)	Accelerate_Percent (%)
777300	ICAO_B	7	4	Climb	MaxTakeoff	T_00_U	2 216			
777300	ICAO_B	7	5	Climb	MaxClimb	T_00_U	3 000			
777300	ICAO_B	7	6	Accelerate	MaxClimb	T_00_U		1 271,6	250	
777300	ICAO_B	7	7	Climb	MaxClimb	T_00_U	5 000			
777300	ICAO_B	7	8	Climb	MaxClimb	T_00_U	7 500			
777300	ICAO_B	7	9	Climb	MaxClimb	T_00_U	10 000			
7773ER	DEFAULT	1	1	Takeoff	MaxTakeoff	FLAP_5				
7773ER	DEFAULT	1	2	Climb	MaxTakeoff	FLAP_5	1 434			
7773ER	DEFAULT	1	3	Accelerate_Percent	MaxClimb	FLAP_5			200	55
7773ER	DEFAULT	1	4	Accelerate_Percent	MaxClimb	FLAP_1			223	50
7773ER	DEFAULT	1	5	Climb	MaxClimb	FLAP_0	3 000			
7773ER	DEFAULT	1	6	Accelerate_Percent	MaxClimb	FLAP_0			250	50
7773ER	DEFAULT	1	7	Climb	MaxClimb	FLAP_0	10 000			
7773ER	DEFAULT	2	1	Takeoff	MaxTakeoff	FLAP_5				
7773ER	DEFAULT	2	2	Climb	MaxTakeoff	FLAP_5	1 434			
7773ER	DEFAULT	2	3	Accelerate_Percent	MaxClimb	FLAP_5			200	55
7773ER	DEFAULT	2	4	Accelerate_Percent	MaxClimb	FLAP_1			225	50
7773ER	DEFAULT	2	5	Climb	MaxClimb	FLAP_0	3 000			
7773ER	DEFAULT	2	6	Accelerate_Percent	MaxClimb	FLAP_0			250	50
7773ER	DEFAULT	2	7	Climb	MaxClimb	FLAP_0	10 000			

ACFTID	Profile_ID	Stage Length	Step Number	Step Type	Thrust Rating	Flap_ID	End Point Altitude (ft)	Rate Of Climb (ft/min)	End Point CAS (kt)	Accelerate_Percent (%)
7773ER	DEFAULT	3	1	Takeoff	MaxTakeoff	FLAP_5				
7773ER	DEFAULT	3	2	Climb	MaxTakeoff	FLAP_5	1 355			
7773ER	DEFAULT	3	3	Accelerate_Percent	MaxClimb	FLAP_5			204	55
7773ER	DEFAULT	3	4	Accelerate_Percent	MaxClimb	FLAP_1			228	50
7773ER	DEFAULT	3	5	Climb	MaxClimb	FLAP_0	3 000			
7773ER	DEFAULT	3	6	Accelerate_Percent	MaxClimb	FLAP_0			250	50
7773ER	DEFAULT	3	7	Climb	MaxClimb	FLAP_0	10 000			
7773ER	DEFAULT	4	1	Takeoff	MaxTakeoff	FLAP_5				
7773ER	DEFAULT	4	2	Climb	MaxTakeoff	FLAP_5	1 289			
7773ER	DEFAULT	4	3	Accelerate_Percent	MaxClimb	FLAP_5			205	55
7773ER	DEFAULT	4	4	Accelerate_Percent	MaxClimb	FLAP_1			230	50
7773ER	DEFAULT	4	5	Climb	MaxClimb	FLAP_0	3 000			
7773ER	DEFAULT	4	6	Accelerate_Percent	MaxClimb	FLAP_0			250	50
7773ER	DEFAULT	4	7	Climb	MaxClimb	FLAP_0	10 000			
7773ER	DEFAULT	5	1	Takeoff	MaxTakeoff	FLAP_5				
7773ER	DEFAULT	5	2	Climb	MaxTakeoff	FLAP_5	1 214			
7773ER	DEFAULT	5	3	Accelerate_Percent	MaxClimb	FLAP_5			210	55
7773ER	DEFAULT	5	4	Accelerate_Percent	MaxClimb	FLAP_1			235	50
7773ER	DEFAULT	5	5	Climb	MaxClimb	FLAP_0	3 000			
7773ER	DEFAULT	5	6	Accelerate_Percent	MaxClimb	FLAP_0			250	50

ACFTID	Profile_ID	Stage Length	Step Number	Step Type	Thrust Rating	Flap_ID	End Point Altitude (ft)	Rate Of Climb (ft/min)	End Point CAS (kt)	Accelerate_Percent (%)
7773ER	DEFAULT	5	7	Climb	MaxClimb	FLAP_0	10 000			
7773ER	DEFAULT	6	1	Takeoff	MaxTakeoff	FLAP_5				
7773ER	DEFAULT	6	2	Climb	MaxTakeoff	FLAP_5	1 142			
7773ER	DEFAULT	6	3	Accelerate_Percent	MaxClimb	FLAP_5			215	55
7773ER	DEFAULT	6	4	Accelerate_Percent	MaxClimb	FLAP_1			240	50
7773ER	DEFAULT	6	5	Climb	MaxClimb	FLAP_0	3 000			
7773ER	DEFAULT	6	6	Accelerate_Percent	MaxClimb	FLAP_0			250	50
7773ER	DEFAULT	6	7	Climb	MaxClimb	FLAP_0	10 000			
7773ER	DEFAULT	7	1	Takeoff	MaxTakeoff	FLAP_5				
7773ER	DEFAULT	7	2	Climb	MaxTakeoff	FLAP_5	1 067			
7773ER	DEFAULT	7	3	Accelerate_Percent	MaxClimb	FLAP_5			222	55
7773ER	DEFAULT	7	4	Accelerate_Percent	MaxClimb	FLAP_1			248	50
7773ER	DEFAULT	7	5	Climb	MaxClimb	FLAP_0	3 000			
7773ER	DEFAULT	7	6	Accelerate_Percent	MaxClimb	FLAP_0			250	50
7773ER	DEFAULT	7	7	Climb	MaxClimb	FLAP_0	10 000			
7773ER	DEFAULT	8	1	Takeoff	MaxTakeoff	FLAP_5				
7773ER	DEFAULT	8	2	Climb	MaxTakeoff	FLAP_5	1 000			
7773ER	DEFAULT	8	3	Accelerate_Percent	MaxClimb	FLAP_5			222	55
7773ER	DEFAULT	8	4	Accelerate_Percent	MaxClimb	FLAP_1			255	50
7773ER	DEFAULT	8	5	Climb	MaxClimb	FLAP_0	3 000			

ACFTID	Profile_ID	Stage Length	Step Number	Step Type	Thrust Rating	Flap_ID	End Point Altitude (ft)	Rate Of Climb (ft/min)	End Point CAS (kt)	Accelerate_Percent (%)
7773ER	DEFAULT	8	6	Accelerate_Percent	MaxClimb	FLAP_0			256	50
7773ER	DEFAULT	8	7	Climb	MaxClimb	FLAP_0	10 000			
7773ER	DEFAULT	9	1	Takeoff	MaxTakeoff	FLAP_5				
7773ER	DEFAULT	9	2	Climb	MaxTakeoff	FLAP_5	1 000			
7773ER	DEFAULT	9	3	Accelerate_Percent	MaxClimb	FLAP_5			226	55
7773ER	DEFAULT	9	4	Accelerate_Percent	MaxClimb	FLAP_1			261	50
7773ER	DEFAULT	9	5	Climb	MaxClimb	FLAP_0	3 000			
7773ER	DEFAULT	9	6	Accelerate_Percent	MaxClimb	FLAP_0			261,1	50
7773ER	DEFAULT	9	7	Climb	MaxClimb	FLAP_0	10 000			
7773ER	ICAO_A	1	1	Takeoff	MaxTakeoff	FLAP_5				
7773ER	ICAO_A	1	2	Climb	MaxTakeoff	FLAP_5	1 500			
7773ER	ICAO_A	1	3	Climb	MaxClimb	FLAP_5	3 000			
7773ER	ICAO_A	1	4	Accelerate_Percent	MaxClimb	FLAP_5			210	55
7773ER	ICAO_A	1	5	Accelerate_Percent	MaxClimb	FLAP_1			220	55
7773ER	ICAO_A	1	6	Climb	MaxClimb	FLAP_1	4 400			
7773ER	ICAO_A	1	7	Accelerate_Percent	MaxClimb	FLAP_0			250	50
7773ER	ICAO_A	1	8	Climb	MaxClimb	FLAP_0	10 000			
7773ER	ICAO_A	2	1	Takeoff	MaxTakeoff	FLAP_5				
7773ER	ICAO_A	2	2	Climb	MaxTakeoff	FLAP_5	1 500			
7773ER	ICAO_A	2	3	Climb	MaxClimb	FLAP_5	3 000			

ACFTID	Profile_ID	Stage Length	Step Number	Step Type	Thrust Rating	Flap_ID	End Point Altitude (ft)	Rate Of Climb (ft/min)	End Point CAS (kt)	Accelerate_Percent (%)
7773ER	ICAO_A	2	4	Accelerate_Percent	MaxClimb	FLAP_5			220	55
7773ER	ICAO_A	2	5	Accelerate_Percent	MaxClimb	FLAP_1			230	55
7773ER	ICAO_A	2	6	Climb	MaxClimb	FLAP_1	4 300			
7773ER	ICAO_A	2	7	Accelerate_Percent	MaxClimb	FLAP_0			250	50
7773ER	ICAO_A	2	8	Climb	MaxClimb	FLAP_0	10 000			
7773ER	ICAO_A	3	1	Takeoff	MaxTakeoff	FLAP_5				
7773ER	ICAO_A	3	2	Climb	MaxTakeoff	FLAP_5	1 500			
7773ER	ICAO_A	3	3	Climb	MaxClimb	FLAP_5	3 000			
7773ER	ICAO_A	3	4	Accelerate_Percent	MaxClimb	FLAP_5			220	55
7773ER	ICAO_A	3	5	Accelerate_Percent	MaxClimb	FLAP_1			230	55
7773ER	ICAO_A	3	6	Climb	MaxClimb	FLAP_1	4 200			
7773ER	ICAO_A	3	7	Accelerate_Percent	MaxClimb	FLAP_0			250	50
7773ER	ICAO_A	3	8	Climb	MaxClimb	FLAP_0	10 000			
7773ER	ICAO_A	4	1	Takeoff	MaxTakeoff	FLAP_5				
7773ER	ICAO_A	4	2	Climb	MaxTakeoff	FLAP_5	1 500			
7773ER	ICAO_A	4	3	Climb	MaxClimb	FLAP_5	3 000			
7773ER	ICAO_A	4	4	Accelerate_Percent	MaxClimb	FLAP_5			220	55
7773ER	ICAO_A	4	5	Accelerate_Percent	MaxClimb	FLAP_1			230	55
7773ER	ICAO_A	4	6	Climb	MaxClimb	FLAP_1	4 100			
7773ER	ICAO_A	4	7	Accelerate_Percent	MaxClimb	FLAP_0			250	50

ACFTID	Profile_ID	Stage Length	Step Number	Step Type	Thrust Rating	Flap_ID	End Point Altitude (ft)	Rate Of Climb (ft/min)	End Point CAS (kt)	Accelerate_Percent (%)
7773ER	ICAO_A	4	8	Climb	MaxClimb	FLAP_0	10 000			
7773ER	ICAO_A	5	1	Takeoff	MaxTakeoff	FLAP_5				
7773ER	ICAO_A	5	2	Climb	MaxTakeoff	FLAP_5	1 500			
7773ER	ICAO_A	5	3	Climb	MaxClimb	FLAP_5	3 000			
7773ER	ICAO_A	5	4	Accelerate_Percent	MaxClimb	FLAP_5			220	55
7773ER	ICAO_A	5	5	Accelerate_Percent	MaxClimb	FLAP_1			230	55
7773ER	ICAO_A	5	6	Accelerate_Percent	MaxClimb	FLAP_0			250	50
7773ER	ICAO_A	5	7	Climb	MaxClimb	FLAP_0	10 000			
7773ER	ICAO_A	6	1	Takeoff	MaxTakeoff	FLAP_5				
7773ER	ICAO_A	6	2	Climb	MaxTakeoff	FLAP_5	1 500			
7773ER	ICAO_A	6	3	Climb	MaxClimb	FLAP_5	3 000			
7773ER	ICAO_A	6	4	Accelerate_Percent	MaxClimb	FLAP_5			220	55
7773ER	ICAO_A	6	5	Accelerate_Percent	MaxClimb	FLAP_1			230	55
7773ER	ICAO_A	6	6	Accelerate_Percent	MaxClimb	FLAP_0			250	50
7773ER	ICAO_A	6	7	Climb	MaxClimb	FLAP_0	10 000			
7773ER	ICAO_A	7	1	Takeoff	MaxTakeoff	FLAP_5				
7773ER	ICAO_A	7	2	Climb	MaxTakeoff	FLAP_5	1 500			
7773ER	ICAO_A	7	3	Climb	MaxClimb	FLAP_5	3 000			
7773ER	ICAO_A	7	4	Accelerate_Percent	MaxClimb	FLAP_5			220	55
7773ER	ICAO_A	7	5	Accelerate_Percent	MaxClimb	FLAP_1			230	55

ACFTID	Profile_ID	Stage Length	Step Number	Step Type	Thrust Rating	Flap_ID	End Point Altitude (ft)	Rate Of Climb (ft/min)	End Point CAS (kt)	Accelerate_Percent (%)
7773ER	ICAO_A	7	6	Accelerate_Percent	MaxClimb	FLAP_0			250	50
7773ER	ICAO_A	7	7	Climb	MaxClimb	FLAP_0	10 000			
7773ER	ICAO_A	8	1	Takeoff	MaxTakeoff	FLAP_5				
7773ER	ICAO_A	8	2	Climb	MaxTakeoff	FLAP_5	1 500			
7773ER	ICAO_A	8	3	Climb	MaxClimb	FLAP_5	3 000			
7773ER	ICAO_A	8	4	Accelerate_Percent	MaxClimb	FLAP_5			220	55
7773ER	ICAO_A	8	5	Accelerate_Percent	MaxClimb	FLAP_1			230	55
7773ER	ICAO_A	8	6	Accelerate_Percent	MaxClimb	FLAP_0			255	50
7773ER	ICAO_A	8	7	Climb	MaxClimb	FLAP_0	10 000			
7773ER	ICAO_A	9	1	Takeoff	MaxTakeoff	FLAP_5				
7773ER	ICAO_A	9	2	Climb	MaxTakeoff	FLAP_5	1 500			
7773ER	ICAO_A	9	3	Climb	MaxClimb	FLAP_5	3 000			
7773ER	ICAO_A	9	4	Accelerate_Percent	MaxClimb	FLAP_5			230	55
7773ER	ICAO_A	9	5	Accelerate_Percent	MaxClimb	FLAP_1			240	55
7773ER	ICAO_A	9	6	Accelerate_Percent	MaxClimb	FLAP_0			260	50
7773ER	ICAO_A	9	7	Climb	MaxClimb	FLAP_0	10 000			
7773ER	ICAO_B	1	1	Takeoff	MaxTakeoff	FLAP_5				
7773ER	ICAO_B	1	2	Climb	MaxTakeoff	FLAP_5	1 434			
7773ER	ICAO_B	1	3	Accelerate_Percent	MaxTakeoff	FLAP_5			223	55
7773ER	ICAO_B	1	4	Climb	MaxTakeoff	FLAP_1	3 564			

ACFTID	Profile_ID	Stage Length	Step Number	Step Type	Thrust Rating	Flap_ID	End Point Altitude (ft)	Rate Of Climb (ft/min)	End Point CAS (kt)	Accelerate_Percent (%)
7773ER	ICAO_B	1	5	Accelerate_Percent	MaxClimb	FLAP_0			240	50
7773ER	ICAO_B	1	6	Accelerate_Percent	MaxClimb	FLAP_0			250	50
7773ER	ICAO_B	1	7	Climb	MaxClimb	FLAP_0	10 000			
7773ER	ICAO_B	2	1	Takeoff	MaxTakeoff	FLAP_5				
7773ER	ICAO_B	2	2	Climb	MaxTakeoff	FLAP_5	1 396			
7773ER	ICAO_B	2	3	Accelerate_Percent	MaxTakeoff	FLAP_5			225	55
7773ER	ICAO_B	2	4	Climb	MaxTakeoff	FLAP_1	3 442			
7773ER	ICAO_B	2	5	Accelerate_Percent	MaxClimb	FLAP_0			240	50
7773ER	ICAO_B	2	6	Accelerate_Percent	MaxClimb	FLAP_0			250	50
7773ER	ICAO_B	2	7	Climb	MaxClimb	FLAP_0	10 000			
7773ER	ICAO_B	3	1	Takeoff	MaxTakeoff	FLAP_5				
7773ER	ICAO_B	3	2	Climb	MaxTakeoff	FLAP_5	1 355			
7773ER	ICAO_B	3	3	Accelerate_Percent	MaxTakeoff	FLAP_5			228	55
7773ER	ICAO_B	3	4	Climb	MaxTakeoff	FLAP_1	3 314			
7773ER	ICAO_B	3	5	Accelerate_Percent	MaxClimb	FLAP_0			240	50
7773ER	ICAO_B	3	6	Accelerate_Percent	MaxClimb	FLAP_0			250	50
7773ER	ICAO_B	3	7	Climb	MaxClimb	FLAP_0	10 000			
7773ER	ICAO_B	4	1	Takeoff	MaxTakeoff	FLAP_5				
7773ER	ICAO_B	4	2	Climb	MaxTakeoff	FLAP_5	1 289			
7773ER	ICAO_B	4	3	Accelerate_Percent	MaxTakeoff	FLAP_5			231	55

ACFTID	Profile_ID	Stage Length	Step Number	Step Type	Thrust Rating	Flap_ID	End Point Altitude (ft)	Rate Of Climb (ft/min)	End Point CAS (kt)	Accelerate_Percent (%)
7773ER	ICAO_B	4	4	Climb	MaxTakeoff	FLAP_1	3 104			
7773ER	ICAO_B	4	5	Accelerate_Percent	MaxClimb	FLAP_0			240	50
7773ER	ICAO_B	4	6	Accelerate_Percent	MaxClimb	FLAP_0			250	50
7773ER	ICAO_B	4	7	Climb	MaxClimb	FLAP_0	10 000			
7773ER	ICAO_B	5	1	Takeoff	MaxTakeoff	FLAP_5				
7773ER	ICAO_B	5	2	Climb	MaxTakeoff	FLAP_5	1 214			
7773ER	ICAO_B	5	3	Accelerate_Percent	MaxTakeoff	FLAP_5			236	55
7773ER	ICAO_B	5	4	Climb	MaxTakeoff	FLAP_1	3 000			
7773ER	ICAO_B	5	5	Accelerate_Percent	MaxClimb	FLAP_0			245	50
7773ER	ICAO_B	5	6	Accelerate_Percent	MaxClimb	FLAP_0			250	50
7773ER	ICAO_B	5	7	Climb	MaxClimb	FLAP_0	10 000			
7773ER	ICAO_B	6	1	Takeoff	MaxTakeoff	FLAP_5				
7773ER	ICAO_B	6	2	Climb	MaxTakeoff	FLAP_5	1 138			
7773ER	ICAO_B	6	3	Accelerate_Percent	MaxTakeoff	FLAP_5			241	55
7773ER	ICAO_B	6	4	Climb	MaxTakeoff	FLAP_1	3 000			
7773ER	ICAO_B	6	5	Accelerate_Percent	MaxClimb	FLAP_0			250	50
7773ER	ICAO_B	6	6	Climb	MaxClimb	FLAP_0	10 000			
7773ER	ICAO_B	7	1	Takeoff	MaxTakeoff	FLAP_5				
7773ER	ICAO_B	7	2	Climb	MaxTakeoff	FLAP_5	1 067			
7773ER	ICAO_B	7	3	Accelerate_Percent	MaxTakeoff	FLAP_5			249	55

ACFTID	Profile_ID	Stage Length	Step Number	Step Type	Thrust Rating	Flap_ID	End Point Altitude (ft)	Rate Of Climb (ft/min)	End Point CAS (kt)	Accelerate_Percent (%)
7773ER	ICAO_B	7	4	Climb	MaxTakeoff	FLAP_1	2 451			
7773ER	ICAO_B	7	5	Accelerate_Percent	MaxClimb	FLAP_1			250	55
7773ER	ICAO_B	7	6	Climb	MaxClimb	FLAP_0	3 000			
7773ER	ICAO_B	7	7	Climb	MaxClimb	FLAP_0	10 000			
7773ER	ICAO_B	8	1	Takeoff	MaxTakeoff	FLAP_5				
7773ER	ICAO_B	8	2	Climb	MaxTakeoff	FLAP_5	1 000			
7773ER	ICAO_B	8	3	Accelerate_Percent	MaxTakeoff	FLAP_5			257	55
7773ER	ICAO_B	8	4	Climb	MaxTakeoff	FLAP_1	2 280			
7773ER	ICAO_B	8	5	Accelerate_Percent	MaxClimb	FLAP_1			257	55
7773ER	ICAO_B	8	6	Climb	MaxClimb	FLAP_0	3 000			
7773ER	ICAO_B	8	7	Climb	MaxClimb	FLAP_0	10 000			
7773ER	ICAO_B	9	1	Takeoff	MaxTakeoff	FLAP_5				
7773ER	ICAO_B	9	2	Climb	MaxTakeoff	FLAP_5	1 000			
7773ER	ICAO_B	9	3	Accelerate_Percent	MaxTakeoff	FLAP_5			261	55
7773ER	ICAO_B	9	4	Climb	MaxTakeoff	FLAP_1	2 180			
7773ER	ICAO_B	9	5	Accelerate_Percent	MaxClimb	FLAP_1			262	55
7773ER	ICAO_B	9	6	Climb	MaxClimb	FLAP_0	3 000			
7773ER	ICAO_B	9	7	Climb	MaxClimb	FLAP_0	10 000			
7878R	DEFAULT	1	1	Takeoff	MaxTakeoff	FLAP_5				
7878R	DEFAULT	1	2	Climb	MaxTakeoff	FLAP_5	1 000			

ACFTID	Profile_ID	Stage Length	Step Number	Step Type	Thrust Rating	Flap_ID	End Point Altitude (ft)	Rate Of Climb (ft/min)	End Point CAS (kt)	Accelerate_Percent (%)
7878R	DEFAULT	1	3	Accelerate_Percent	MaxClimb	FLAP_5			214	55
7878R	DEFAULT	1	4	Accelerate_Percent	MaxClimb	FLAP_1			225	55
7878R	DEFAULT	1	5	Climb	MaxClimb	FLAP_0	3 000			
7878R	DEFAULT	1	6	Accelerate_Percent	MaxClimb	FLAP_0			250	50
7878R	DEFAULT	1	7	Climb	MaxClimb	FLAP_0	10 000			
7878R	DEFAULT	2	1	Takeoff	MaxTakeoff	FLAP_5				
7878R	DEFAULT	2	2	Climb	MaxTakeoff	FLAP_5	1 000			
7878R	DEFAULT	2	3	Accelerate_Percent	MaxClimb	FLAP_5			214	55
7878R	DEFAULT	2	4	Accelerate_Percent	MaxClimb	FLAP_1			222	55
7878R	DEFAULT	2	5	Climb	MaxClimb	FLAP_0	3 000			
7878R	DEFAULT	2	6	Accelerate_Percent	MaxClimb	FLAP_0			250	50
7878R	DEFAULT	2	7	Climb	MaxClimb	FLAP_0	10 000			
7878R	DEFAULT	3	1	Takeoff	MaxTakeoff	FLAP_5				
7878R	DEFAULT	3	2	Climb	MaxTakeoff	FLAP_5	1 000			
7878R	DEFAULT	3	3	Accelerate_Percent	MaxClimb	FLAP_5			215	55
7878R	DEFAULT	3	4	Accelerate_Percent	MaxClimb	FLAP_1			230	55
7878R	DEFAULT	3	5	Climb	MaxClimb	FLAP_0	3 000			
7878R	DEFAULT	3	6	Accelerate_Percent	MaxClimb	FLAP_0			250	50
7878R	DEFAULT	3	7	Climb	MaxClimb	FLAP_0	10 000			
7878R	DEFAULT	4	1	Takeoff	MaxTakeoff	FLAP_5				

ACFTID	Profile_ID	Stage Length	Step Number	Step Type	Thrust Rating	Flap_ID	End Point Altitude (ft)	Rate Of Climb (ft/min)	End Point CAS (kt)	Accelerate_Percent (%)
7878R	DEFAULT	4	2	Climb	MaxTakeoff	FLAP_5	1 000			
7878R	DEFAULT	4	3	Accelerate_Percent	MaxClimb	FLAP_5			215	55
7878R	DEFAULT	4	4	Accelerate_Percent	MaxClimb	FLAP_1			228	55
7878R	DEFAULT	4	5	Climb	MaxClimb	FLAP_0	3 000			
7878R	DEFAULT	4	6	Accelerate_Percent	MaxClimb	FLAP_0			250	50
7878R	DEFAULT	4	7	Climb	MaxClimb	FLAP_0	10 000			
7878R	DEFAULT	5	1	Takeoff	MaxTakeoff	FLAP_5				
7878R	DEFAULT	5	2	Climb	MaxTakeoff	FLAP_5	1 000			
7878R	DEFAULT	5	3	Accelerate_Percent	MaxClimb	FLAP_5			218	55
7878R	DEFAULT	5	4	Accelerate_Percent	MaxClimb	FLAP_1			235	55
7878R	DEFAULT	5	5	Climb	MaxClimb	FLAP_0	3 000			
7878R	DEFAULT	5	6	Accelerate_Percent	MaxClimb	FLAP_0			250	50
7878R	DEFAULT	5	7	Climb	MaxClimb	FLAP_0	10 000			
7878R	DEFAULT	6	1	Takeoff	MaxTakeoff	FLAP_5				
7878R	DEFAULT	6	2	Climb	MaxTakeoff	FLAP_5	1 000			
7878R	DEFAULT	6	3	Accelerate_Percent	MaxClimb	FLAP_5			220	55
7878R	DEFAULT	6	4	Accelerate_Percent	MaxClimb	FLAP_1			238	55
7878R	DEFAULT	6	5	Climb	MaxClimb	FLAP_0	3 000			
7878R	DEFAULT	6	6	Accelerate_Percent	MaxClimb	FLAP_0			250	50
7878R	DEFAULT	6	7	Climb	MaxClimb	FLAP_0	10 000			

ACFTID	Profile_ID	Stage Length	Step Number	Step Type	Thrust Rating	Flap_ID	End Point Altitude (ft)	Rate Of Climb (ft/min)	End Point CAS (kt)	Accelerate_Percent (%)
7878R	DEFAULT	7	1	Takeoff	MaxTakeoff	FLAP_5				
7878R	DEFAULT	7	2	Climb	MaxTakeoff	FLAP_5	1 000			
7878R	DEFAULT	7	3	Accelerate_Percent	MaxClimb	FLAP_5			224	55
7878R	DEFAULT	7	4	Accelerate_Percent	MaxClimb	FLAP_1			243	55
7878R	DEFAULT	7	5	Climb	MaxClimb	FLAP_0	3 000			
7878R	DEFAULT	7	6	Accelerate_Percent	MaxClimb	FLAP_0			250	50
7878R	DEFAULT	7	7	Climb	MaxClimb	FLAP_0	10 000			
7878R	DEFAULT	8	1	Takeoff	MaxTakeoff	FLAP_5				
7878R	DEFAULT	8	2	Climb	MaxTakeoff	FLAP_5	1 000			
7878R	DEFAULT	8	3	Accelerate_Percent	MaxClimb	FLAP_5			226	55
7878R	DEFAULT	8	4	Accelerate_Percent	MaxClimb	FLAP_1			246	55
7878R	DEFAULT	8	5	Climb	MaxClimb	FLAP_0	3 000			
7878R	DEFAULT	8	6	Accelerate_Percent	MaxClimb	FLAP_0			250	50
7878R	DEFAULT	8	7	Climb	MaxClimb	FLAP_0	10 000			
7878R	DEFAULT	9	1	Takeoff	MaxTakeoff	FLAP_5				
7878R	DEFAULT	9	2	Climb	MaxTakeoff	FLAP_5	1 000			
7878R	DEFAULT	9	3	Accelerate_Percent	MaxClimb	FLAP_5			230	55
7878R	DEFAULT	9	4	Accelerate_Percent	MaxClimb	FLAP_1			245	55
7878R	DEFAULT	9	5	Climb	MaxClimb	FLAP_0	3 000			
7878R	DEFAULT	9	6	Accelerate_Percent	MaxClimb	FLAP_0			250	50

ACFTID	Profile_ID	Stage Length	Step Number	Step Type	Thrust Rating	Flap_ID	End Point Altitude (ft)	Rate Of Climb (ft/min)	End Point CAS (kt)	Accelerate_Percent (%)
7878R	DEFAULT	9	7	Climb	MaxClimb	FLAP_0	10 000			
7878R	ICAO_A	1	1	Takeoff	MaxTakeoff	FLAP_5				
7878R	ICAO_A	1	2	Climb	MaxTakeoff	FLAP_5	1 500			
7878R	ICAO_A	1	3	Climb	MaxClimb	FLAP_5	3 000			
7878R	ICAO_A	1	4	Accelerate_Percent	MaxClimb	FLAP_5			220	55
7878R	ICAO_A	1	5	Climb	MaxClimb	FLAP_1	4 500			
7878R	ICAO_A	1	6	Accelerate_Percent	MaxClimb	FLAP_0			250	50
7878R	ICAO_A	1	7	Climb	MaxClimb	FLAP_0	10 000			
7878R	ICAO_A	2	1	Takeoff	MaxTakeoff	FLAP_5				
7878R	ICAO_A	2	2	Climb	MaxTakeoff	FLAP_5	1 500			
7878R	ICAO_A	2	3	Climb	MaxClimb	FLAP_5	3 000			
7878R	ICAO_A	2	4	Accelerate_Percent	MaxClimb	FLAP_5			220	55
7878R	ICAO_A	2	5	Climb	MaxClimb	FLAP_1	4 400			
7878R	ICAO_A	2	6	Accelerate_Percent	MaxClimb	FLAP_0			250	50
7878R	ICAO_A	2	7	Climb	MaxClimb	FLAP_0	10 000			
7878R	ICAO_A	3	1	Takeoff	MaxTakeoff	FLAP_5				
7878R	ICAO_A	3	2	Climb	MaxTakeoff	FLAP_5	1 500			
7878R	ICAO_A	3	3	Climb	MaxClimb	FLAP_5	3 000			
7878R	ICAO_A	3	4	Accelerate_Percent	MaxClimb	FLAP_5			220	55
7878R	ICAO_A	3	5	Climb	MaxClimb	FLAP_1	4 400			

ACFTID	Profile_ID	Stage Length	Step Number	Step Type	Thrust Rating	Flap_ID	End Point Altitude (ft)	Rate Of Climb (ft/min)	End Point CAS (kt)	Accelerate_Percent (%)
7878R	ICAO_A	3	6	Accelerate_Percent	MaxClimb	FLAP_0			250	50
7878R	ICAO_A	3	7	Climb	MaxClimb	FLAP_0	10 000			
7878R	ICAO_A	4	1	Takeoff	MaxTakeoff	FLAP_5				
7878R	ICAO_A	4	2	Climb	MaxTakeoff	FLAP_5	1 500			
7878R	ICAO_A	4	3	Climb	MaxClimb	FLAP_5	3 000			
7878R	ICAO_A	4	4	Accelerate_Percent	MaxClimb	FLAP_5			220	55
7878R	ICAO_A	4	5	Climb	MaxClimb	FLAP_1	4 300			
7878R	ICAO_A	4	6	Accelerate_Percent	MaxClimb	FLAP_0			250	50
7878R	ICAO_A	4	7	Climb	MaxClimb	FLAP_0	10 000			
7878R	ICAO_A	5	1	Takeoff	MaxTakeoff	FLAP_5				
7878R	ICAO_A	5	2	Climb	MaxTakeoff	FLAP_5	1 500			
7878R	ICAO_A	5	3	Climb	MaxClimb	FLAP_5	3 000			
7878R	ICAO_A	5	4	Accelerate_Percent	MaxClimb	FLAP_5			224	55
7878R	ICAO_A	5	5	Climb	MaxClimb	FLAP_1	4 200			
7878R	ICAO_A	5	6	Accelerate_Percent	MaxClimb	FLAP_0			250	50
7878R	ICAO_A	5	7	Climb	MaxClimb	FLAP_0	10 000			
7878R	ICAO_A	6	1	Takeoff	MaxTakeoff	FLAP_5				
7878R	ICAO_A	6	2	Climb	MaxTakeoff	FLAP_5	1 500			
7878R	ICAO_A	6	3	Climb	MaxClimb	FLAP_5	3 000			
7878R	ICAO_A	6	4	Accelerate_Percent	MaxClimb	FLAP_5			226	55

ACFTID	Profile_ID	Stage Length	Step Number	Step Type	Thrust Rating	Flap_ID	End Point Altitude (ft)	Rate Of Climb (ft/min)	End Point CAS (kt)	Accelerate_Percent (%)
7878R	ICAO_A	6	5	Climb	MaxClimb	FLAP_1	4 100			
7878R	ICAO_A	6	6	Accelerate_Percent	MaxClimb	FLAP_0			250	50
7878R	ICAO_A	6	7	Climb	MaxClimb	FLAP_0	10 000			
7878R	ICAO_A	7	1	Takeoff	MaxTakeoff	FLAP_5				
7878R	ICAO_A	7	2	Climb	MaxTakeoff	FLAP_5	1 500			
7878R	ICAO_A	7	3	Climb	MaxClimb	FLAP_5	3 000			
7878R	ICAO_A	7	4	Accelerate_Percent	MaxClimb	FLAP_5			232	55
7878R	ICAO_A	7	5	Climb	MaxClimb	FLAP_1	4 000			
7878R	ICAO_A	7	6	Accelerate_Percent	MaxClimb	FLAP_0			250	50
7878R	ICAO_A	7	7	Climb	MaxClimb	FLAP_0	10 000			
7878R	ICAO_A	8	1	Takeoff	MaxTakeoff	FLAP_5				
7878R	ICAO_A	8	2	Climb	MaxTakeoff	FLAP_5	1 500			
7878R	ICAO_A	8	3	Climb	MaxClimb	FLAP_5	3 000			
7878R	ICAO_A	8	4	Accelerate_Percent	MaxClimb	FLAP_5			232	55
7878R	ICAO_A	8	5	Climb	MaxClimb	FLAP_1	4 000			
7878R	ICAO_A	8	6	Accelerate_Percent	MaxClimb	FLAP_0			250	50
7878R	ICAO_A	8	7	Climb	MaxClimb	FLAP_0	10 000			
7878R	ICAO_A	9	1	Takeoff	MaxTakeoff	FLAP_5				
7878R	ICAO_A	9	2	Climb	MaxTakeoff	FLAP_5	1 500			
7878R	ICAO_A	9	3	Climb	MaxClimb	FLAP_5	3 000			

ACFTID	Profile_ID	Stage Length	Step Number	Step Type	Thrust Rating	Flap_ID	End Point Altitude (ft)	Rate Of Climb (ft/min)	End Point CAS (kt)	Accelerate_Percent (%)
7878R	ICAO_A	9	4	Accelerate_Percent	MaxClimb	FLAP_5			235	55
7878R	ICAO_A	9	5	Climb	MaxClimb	FLAP_1	4 000			
7878R	ICAO_A	9	6	Accelerate_Percent	MaxClimb	FLAP_0			250	50
7878R	ICAO_A	9	7	Climb	MaxClimb	FLAP_0	10 000			
7878R	ICAO_B	1	1	Takeoff	MaxTakeoff	FLAP_5				
7878R	ICAO_B	1	2	Climb	MaxTakeoff	FLAP_5	1 000			
7878R	ICAO_B	1	3	Accelerate_Percent	MaxTakeoff	FLAP_5			220	55
7878R	ICAO_B	1	4	Climb	MaxTakeoff	FLAP_1	2 700			
7878R	ICAO_B	1	5	Climb	MaxClimb	FLAP_0	3 000			
7878R	ICAO_B	1	6	Accelerate_Percent	MaxClimb	FLAP_0			250	50
7878R	ICAO_B	1	7	Climb	MaxClimb	FLAP_0	10 000			
7878R	ICAO_B	2	1	Takeoff	MaxTakeoff	FLAP_5				
7878R	ICAO_B	2	2	Climb	MaxTakeoff	FLAP_5	1 000			
7878R	ICAO_B	2	3	Accelerate_Percent	MaxTakeoff	FLAP_5			220	55
7878R	ICAO_B	2	4	Climb	MaxTakeoff	FLAP_1	2 700			
7878R	ICAO_B	2	5	Climb	MaxClimb	FLAP_0	3 000			
7878R	ICAO_B	2	6	Accelerate_Percent	MaxClimb	FLAP_0			250	50
7878R	ICAO_B	2	7	Climb	MaxClimb	FLAP_0	10 000			
7878R	ICAO_B	3	1	Takeoff	MaxTakeoff	FLAP_5				
7878R	ICAO_B	3	2	Climb	MaxTakeoff	FLAP_5	1 000			

ACFTID	Profile_ID	Stage Length	Step Number	Step Type	Thrust Rating	Flap_ID	End Point Altitude (ft)	Rate Of Climb (ft/min)	End Point CAS (kt)	Accelerate_Percent (%)
7878R	ICAO_B	3	3	Accelerate_Percent	MaxTakeoff	FLAP_5			220	55
7878R	ICAO_B	3	4	Climb	MaxTakeoff	FLAP_1	2 700			
7878R	ICAO_B	3	5	Climb	MaxClimb	FLAP_0	3 000			
7878R	ICAO_B	3	6	Accelerate_Percent	MaxClimb	FLAP_0			250	50
7878R	ICAO_B	3	7	Climb	MaxClimb	FLAP_0	10 000			
7878R	ICAO_B	4	1	Takeoff	MaxTakeoff	FLAP_5				
7878R	ICAO_B	4	2	Climb	MaxTakeoff	FLAP_5	1 000			
7878R	ICAO_B	4	3	Accelerate_Percent	MaxTakeoff	FLAP_5			225	55
7878R	ICAO_B	4	4	Climb	MaxTakeoff	FLAP_1	2 600			
7878R	ICAO_B	4	5	Climb	MaxClimb	FLAP_0	3 000			
7878R	ICAO_B	4	6	Accelerate_Percent	MaxClimb	FLAP_0			250	50
7878R	ICAO_B	4	7	Climb	MaxClimb	FLAP_0	10 000			
7878R	ICAO_B	5	1	Takeoff	MaxTakeoff	FLAP_5				
7878R	ICAO_B	5	2	Climb	MaxTakeoff	FLAP_5	1 000			
7878R	ICAO_B	5	3	Accelerate_Percent	MaxTakeoff	FLAP_5			230	55
7878R	ICAO_B	5	4	Climb	MaxTakeoff	FLAP_1	2 500			
7878R	ICAO_B	5	5	Climb	MaxClimb	FLAP_0	3 000			
7878R	ICAO_B	5	6	Accelerate_Percent	MaxClimb	FLAP_0			250	50
7878R	ICAO_B	5	7	Climb	MaxClimb	FLAP_0	10 000			
7878R	ICAO_B	6	1	Takeoff	MaxTakeoff	FLAP_5				

ACFTID	Profile_ID	Stage Length	Step Number	Step Type	Thrust Rating	Flap_ID	End Point Altitude (ft)	Rate Of Climb (ft/min)	End Point CAS (kt)	Accelerate_Percent (%)
7878R	ICAO_B	6	2	Climb	MaxTakeoff	FLAP_5	1 000			
7878R	ICAO_B	6	3	Accelerate_Percent	MaxTakeoff	FLAP_5			230	55
7878R	ICAO_B	6	4	Climb	MaxTakeoff	FLAP_1	2 400			
7878R	ICAO_B	6	5	Climb	MaxClimb	FLAP_0	3 000			
7878R	ICAO_B	6	6	Accelerate_Percent	MaxClimb	FLAP_0			250	50
7878R	ICAO_B	6	7	Climb	MaxClimb	FLAP_0	10 000			
7878R	ICAO_B	7	1	Takeoff	MaxTakeoff	FLAP_5				
7878R	ICAO_B	7	2	Climb	MaxTakeoff	FLAP_5	1 000			
7878R	ICAO_B	7	3	Accelerate_Percent	MaxTakeoff	FLAP_5			235	55
7878R	ICAO_B	7	4	Climb	MaxTakeoff	FLAP_1	2 200			
7878R	ICAO_B	7	5	Climb	MaxClimb	FLAP_0	3 000			
7878R	ICAO_B	7	6	Accelerate_Percent	MaxClimb	FLAP_0			250	50
7878R	ICAO_B	7	7	Climb	MaxClimb	FLAP_0	10 000			
7878R	ICAO_B	8	1	Takeoff	MaxTakeoff	FLAP_5				
7878R	ICAO_B	8	2	Climb	MaxTakeoff	FLAP_5	1 000			
7878R	ICAO_B	8	3	Accelerate_Percent	MaxTakeoff	FLAP_5			240	55
7878R	ICAO_B	8	4	Climb	MaxTakeoff	FLAP_1	2 100			
7878R	ICAO_B	8	5	Climb	MaxClimb	FLAP_0	3 000			
7878R	ICAO_B	8	6	Accelerate_Percent	MaxClimb	FLAP_0			250	50
7878R	ICAO_B	8	7	Climb	MaxClimb	FLAP_0	10 000			

ACFTID	Profile_ID	Stage Length	Step Number	Step Type	Thrust Rating	Flap_ID	End Point Altitude (ft)	Rate Of Climb (ft/min)	End Point CAS (kt)	Accelerate_Percent (%)
7878R	ICAO_B	9	1	Takeoff	MaxTakeoff	FLAP_5				
7878R	ICAO_B	9	2	Climb	MaxTakeoff	FLAP_5	1 000			
7878R	ICAO_B	9	3	Accelerate_Percent	MaxTakeoff	FLAP_5			245	55
7878R	ICAO_B	9	4	Climb	MaxTakeoff	FLAP_1	2 100			
7878R	ICAO_B	9	5	Climb	MaxClimb	FLAP_0	3 000			
7878R	ICAO_B	9	6	Accelerate_Percent	MaxClimb	FLAP_0			250	50
7878R	ICAO_B	9	7	Climb	MaxClimb	FLAP_0	10 000			
A300-622R	DEFAULT	1	1	Takeoff	MaxTakeoff	1 500				
A300-622R	DEFAULT	1	2	Climb	MaxTakeoff	1 500	1 000			
A300-622R	DEFAULT	1	3	Accelerate	MaxTakeoff	1 500		1 419,5	185,3	
A300-622R	DEFAULT	1	4	Climb	MaxClimb	0	3 000			
A300-622R	DEFAULT	1	5	Accelerate	MaxClimb	0		1 275	250	
A300-622R	DEFAULT	1	6	Climb	MaxClimb	0	5 500			
A300-622R	DEFAULT	1	7	Climb	MaxClimb	0	7 500			
A300-622R	DEFAULT	1	8	Climb	MaxClimb	0	10 000			
A300-622R	DEFAULT	2	1	Takeoff	MaxTakeoff	1 500				
A300-622R	DEFAULT	2	2	Climb	MaxTakeoff	1 500	1 000			
A300-622R	DEFAULT	2	3	Accelerate	MaxTakeoff	1 500		1 361,3	189,3	
A300-622R	DEFAULT	2	4	Climb	MaxClimb	0	3 000			
A300-622R	DEFAULT	2	5	Accelerate	MaxClimb	0		1 216,8	250	

ACFTID	Profile_ID	Stage Length	Step Number	Step Type	Thrust Rating	Flap_ID	End Point Altitude (ft)	Rate Of Climb (ft/min)	End Point CAS (kt)	Accelerate_Percent (%)
A 300-622R	DEFAULT	2	6	Climb	MaxClimb	0	5 500			
A 300-622R	DEFAULT	2	7	Climb	MaxClimb	0	7 500			
A 300-622R	DEFAULT	2	8	Climb	MaxClimb	0	10 000			
A 300-622R	DEFAULT	3	1	Takeoff	MaxTakeoff	1 500				
A 300-622R	DEFAULT	3	2	Climb	MaxTakeoff	1 500	1 000			
A 300-622R	DEFAULT	3	3	Accelerate	MaxTakeoff	1 500		1 303,7	193,2	
A 300-622R	DEFAULT	3	4	Climb	MaxClimb	0	3 000			
A 300-622R	DEFAULT	3	5	Accelerate	MaxClimb	0		1 159,4	250	
A 300-622R	DEFAULT	3	6	Climb	MaxClimb	0	5 500			
A 300-622R	DEFAULT	3	7	Climb	MaxClimb	0	7 500			
A 300-622R	DEFAULT	3	8	Climb	MaxClimb	0	10 000			
A 300-622R	DEFAULT	4	1	Takeoff	MaxTakeoff	1 500				
A 300-622R	DEFAULT	4	2	Climb	MaxTakeoff	1 500	1 000			
A 300-622R	DEFAULT	4	3	Accelerate	MaxTakeoff	1 500		1 210,4	200,1	
A 300-622R	DEFAULT	4	4	Climb	MaxClimb	0	3 000			
A 300-622R	DEFAULT	4	5	Accelerate	MaxClimb	0		1 065,5	250	
A 300-622R	DEFAULT	4	6	Climb	MaxClimb	0	5 500			
A 300-622R	DEFAULT	4	7	Climb	MaxClimb	0	7 500			
A 300-622R	DEFAULT	4	8	Climb	MaxClimb	0	10 000			
A 300-622R	DEFAULT	5	1	Takeoff	MaxTakeoff	1 500				

ACFTID	Profile_ID	Stage Length	Step Number	Step Type	Thrust Rating	Flap_ID	End Point Altitude (ft)	Rate Of Climb (ft/min)	End Point CAS (kt)	Accelerate_Percent (%)
A 300-622R	DEFAULT	5	2	Climb	MaxTakeoff	1 500	1 000			
A 300-622R	DEFAULT	5	3	Accelerate	MaxTakeoff	1 500		1 099,6	209,1	
A 300-622R	DEFAULT	5	4	Climb	MaxClimb	0	3 000			
A 300-622R	DEFAULT	5	5	Accelerate	MaxClimb	0		953,9	250	
A 300-622R	DEFAULT	5	6	Climb	MaxClimb	0	5 500			
A 300-622R	DEFAULT	5	7	Climb	MaxClimb	0	7 500			
A 300-622R	DEFAULT	5	8	Climb	MaxClimb	0	10 000			
A 300-622R	DEFAULT	6	1	Takeoff	MaxTakeoff	1 500				
A 300-622R	DEFAULT	6	2	Climb	MaxTakeoff	1 500	1 000			
A 300-622R	DEFAULT	6	3	Accelerate	MaxTakeoff	1 500		1 015,3	216,4	
A 300-622R	DEFAULT	6	4	Climb	MaxClimb	0	3 000			
A 300-622R	DEFAULT	6	5	Accelerate	MaxClimb	0		870,9	250	
A 300-622R	DEFAULT	6	6	Climb	MaxClimb	0	5 500			
A 300-622R	DEFAULT	6	7	Climb	MaxClimb	0	7 500			
A 300-622R	DEFAULT	6	8	Climb	MaxClimb	0	10 000			
A 300-622R	ICAO_A	1	1	Takeoff	MaxTakeoff	1 500				
A 300-622R	ICAO_A	1	2	Climb	MaxTakeoff	1 500	1 500			
A 300-622R	ICAO_A	1	3	Climb	MaxClimb	1 500	3 000			
A 300-622R	ICAO_A	1	4	Accelerate	MaxClimb	1 500		979,6	185,2	
A 300-622R	ICAO_A	1	5	Accelerate	MaxClimb	0		1 107,6	204,5	

ACFTID	Profile_ID	Stage Length	Step Number	Step Type	Thrust Rating	Flap_ID	End Point Altitude (ft)	Rate Of Climb (ft/min)	End Point CAS (kt)	Accelerate_Percent (%)
A 300-622R	ICAO_A	1	6	Accelerate	MaxClimb	0		1 303,7	250	
A 300-622R	ICAO_A	1	7	Climb	MaxClimb	0	5 500			
A 300-622R	ICAO_A	1	8	Climb	MaxClimb	0	7 500			
A 300-622R	ICAO_A	1	9	Climb	MaxClimb	0	10 000			
A 300-622R	ICAO_A	2	1	Takeoff	MaxTakeoff	1 500				
A 300-622R	ICAO_A	2	2	Climb	MaxTakeoff	1 500	1 500			
A 300-622R	ICAO_A	2	3	Climb	MaxClimb	1 500	3 000			
A 300-622R	ICAO_A	2	4	Accelerate	MaxClimb	1 500		935	189,1	
A 300-622R	ICAO_A	2	5	Accelerate	MaxClimb	0		1 059,7	207,3	
A 300-622R	ICAO_A	2	6	Accelerate	MaxClimb	0		1 241,6	250	
A 300-622R	ICAO_A	2	7	Climb	MaxClimb	0	5 500			
A 300-622R	ICAO_A	2	8	Climb	MaxClimb	0	7 500			
A 300-622R	ICAO_A	2	9	Climb	MaxClimb	0	10 000			
A 300-622R	ICAO_A	3	1	Takeoff	MaxTakeoff	1 500				
A 300-622R	ICAO_A	3	2	Climb	MaxTakeoff	1 500	1 500			
A 300-622R	ICAO_A	3	3	Climb	MaxClimb	1 500	3 000			
A 300-622R	ICAO_A	3	4	Accelerate	MaxClimb	1 500		890,5	193,1	
A 300-622R	ICAO_A	3	5	Accelerate	MaxClimb	0		1 012,1	210,1	
A 300-622R	ICAO_A	3	6	Accelerate	MaxClimb	0		1 180,8	250	
A 300-622R	ICAO_A	3	7	Climb	MaxClimb	0	5 500			

ACFTID	Profile_ID	Stage Length	Step Number	Step Type	Thrust Rating	Flap_ID	End Point Altitude (ft)	Rate Of Climb (ft/min)	End Point CAS (kt)	Accelerate_Percent (%)
A 300-622R	ICAO_A	3	8	Climb	MaxClimb	0	7 500			
A 300-622R	ICAO_A	3	9	Climb	MaxClimb	0	10 000			
A 300-622R	ICAO_A	4	1	Takeoff	MaxTakeoff	1 500				
A 300-622R	ICAO_A	4	2	Climb	MaxTakeoff	1 500	1 500			
A 300-622R	ICAO_A	4	3	Climb	MaxClimb	1 500	3 000			
A 300-622R	ICAO_A	4	4	Accelerate	MaxClimb	1 500		817,4	200	
A 300-622R	ICAO_A	4	5	Accelerate	MaxClimb	0		933,4	215,2	
A 300-622R	ICAO_A	4	6	Accelerate	MaxClimb	0		1 081,4	250	
A 300-622R	ICAO_A	4	7	Climb	MaxClimb	0	5 500			
A 300-622R	ICAO_A	4	8	Climb	MaxClimb	0	7 500			
A 300-622R	ICAO_A	4	9	Climb	MaxClimb	0	10 000			
A 300-622R	ICAO_A	5	1	Takeoff	MaxTakeoff	1 500				
A 300-622R	ICAO_A	5	2	Climb	MaxTakeoff	1 500	1 500			
A 300-622R	ICAO_A	5	3	Climb	MaxClimb	1 500	3 000			
A 300-622R	ICAO_A	5	4	Accelerate	MaxClimb	1 500		729	208,9	
A 300-622R	ICAO_A	5	5	Accelerate	MaxClimb	0		839,1	222,1	
A 300-622R	ICAO_A	5	6	Accelerate	MaxClimb	0		963,8	250	
A 300-622R	ICAO_A	5	7	Climb	MaxClimb	0	5 500			
A 300-622R	ICAO_A	5	8	Climb	MaxClimb	0	7 500			
A 300-622R	ICAO_A	5	9	Climb	MaxClimb	0	10 000			

ACFTID	Profile_ID	Stage Length	Step Number	Step Type	Thrust Rating	Flap_ID	End Point Altitude (ft)	Rate Of Climb (ft/min)	End Point CAS (kt)	Accelerate_Percent (%)
A 300-622R	ICAO_A	6	1	Takeoff	MaxTakeoff	1 500				
A 300-622R	ICAO_A	6	2	Climb	MaxTakeoff	1 500	1 500			
A 300-622R	ICAO_A	6	3	Climb	MaxClimb	1 500	3 000			
A 300-622R	ICAO_A	6	4	Accelerate	MaxClimb	1 500		660,6	216,3	
A 300-622R	ICAO_A	6	5	Accelerate	MaxClimb	0		765,7	227,9	
A 300-622R	ICAO_A	6	6	Accelerate	MaxClimb	0		876,5	250	
A 300-622R	ICAO_A	6	7	Climb	MaxClimb	0	5 500			
A 300-622R	ICAO_A	6	8	Climb	MaxClimb	0	7 500			
A 300-622R	ICAO_A	6	9	Climb	MaxClimb	0	10 000			
A 300-622R	ICAO_B	1	1	Takeoff	MaxTakeoff	1 500				
A 300-622R	ICAO_B	1	2	Climb	MaxTakeoff	1 500	1 000			
A 300-622R	ICAO_B	1	3	Accelerate	MaxTakeoff	1 500		1 419,5	185,3	
A 300-622R	ICAO_B	1	4	Climb	MaxClimb	0	3 000			
A 300-622R	ICAO_B	1	5	Accelerate	MaxClimb	0		1 275	250	
A 300-622R	ICAO_B	1	6	Climb	MaxClimb	0	5 500			
A 300-622R	ICAO_B	1	7	Climb	MaxClimb	0	7 500			
A 300-622R	ICAO_B	1	8	Climb	MaxClimb	0	10 000			
A 300-622R	ICAO_B	2	1	Takeoff	MaxTakeoff	1 500				
A 300-622R	ICAO_B	2	2	Climb	MaxTakeoff	1 500	1 000			
A 300-622R	ICAO_B	2	3	Accelerate	MaxTakeoff	1 500		1 361,3	189,3	

ACFTID	Profile_ID	Stage Length	Step Number	Step Type	Thrust Rating	Flap_ID	End Point Altitude (ft)	Rate Of Climb (ft/min)	End Point CAS (kt)	Accelerate_Percent (%)
A 300-622R	ICAO_B	2	4	Climb	MaxClimb	0	3 000			
A 300-622R	ICAO_B	2	5	Accelerate	MaxClimb	0		1 216,8	250	
A 300-622R	ICAO_B	2	6	Climb	MaxClimb	0	5 500			
A 300-622R	ICAO_B	2	7	Climb	MaxClimb	0	7 500			
A 300-622R	ICAO_B	2	8	Climb	MaxClimb	0	10 000			
A 300-622R	ICAO_B	3	1	Takeoff	MaxTakeoff	1 500				
A 300-622R	ICAO_B	3	2	Climb	MaxTakeoff	1 500	1 000			
A 300-622R	ICAO_B	3	3	Accelerate	MaxTakeoff	1 500		1 303,7	193,2	
A 300-622R	ICAO_B	3	4	Climb	MaxClimb	0	3 000			
A 300-622R	ICAO_B	3	5	Accelerate	MaxClimb	0		1 159,4	250	
A 300-622R	ICAO_B	3	6	Climb	MaxClimb	0	5 500			
A 300-622R	ICAO_B	3	7	Climb	MaxClimb	0	7 500			
A 300-622R	ICAO_B	3	8	Climb	MaxClimb	0	10 000			
A 300-622R	ICAO_B	4	1	Takeoff	MaxTakeoff	1 500				
A 300-622R	ICAO_B	4	2	Climb	MaxTakeoff	1 500	1 000			
A 300-622R	ICAO_B	4	3	Accelerate	MaxTakeoff	1 500		1 210,4	200,1	
A 300-622R	ICAO_B	4	4	Climb	MaxClimb	0	3 000			
A 300-622R	ICAO_B	4	5	Accelerate	MaxClimb	0		1 065,5	250	
A 300-622R	ICAO_B	4	6	Climb	MaxClimb	0	5 500			
A 300-622R	ICAO_B	4	7	Climb	MaxClimb	0	7 500			

ACFTID	Profile_ID	Stage Length	Step Number	Step Type	Thrust Rating	Flap_ID	End Point Altitude (ft)	Rate Of Climb (ft/min)	End Point CAS (kt)	Accelerate_Percent (%)
A 300-622R	ICAO_B	4	8	Climb	MaxClimb	0	10 000			
A 300-622R	ICAO_B	5	1	Takeoff	MaxTakeoff	1 500				
A 300-622R	ICAO_B	5	2	Climb	MaxTakeoff	1 500	1 000			
A 300-622R	ICAO_B	5	3	Accelerate	MaxTakeoff	1 500		1 099,6	209,1	
A 300-622R	ICAO_B	5	4	Climb	MaxClimb	0	3 000			
A 300-622R	ICAO_B	5	5	Accelerate	MaxClimb	0		953,9	250	
A 300-622R	ICAO_B	5	6	Climb	MaxClimb	0	5 500			
A 300-622R	ICAO_B	5	7	Climb	MaxClimb	0	7 500			
A 300-622R	ICAO_B	5	8	Climb	MaxClimb	0	10 000			
A 300-622R	ICAO_B	6	1	Takeoff	MaxTakeoff	1 500				
A 300-622R	ICAO_B	6	2	Climb	MaxTakeoff	1 500	1 000			
A 300-622R	ICAO_B	6	3	Accelerate	MaxTakeoff	1 500		1 015,3	216,4	
A 300-622R	ICAO_B	6	4	Climb	MaxClimb	0	3 000			
A 300-622R	ICAO_B	6	5	Accelerate	MaxClimb	0		870,9	250	
A 300-622R	ICAO_B	6	6	Climb	MaxClimb	0	5 500			
A 300-622R	ICAO_B	6	7	Climb	MaxClimb	0	7 500			
A 300-622R	ICAO_B	6	8	Climb	MaxClimb	0	10 000			
A 300B4-203	DEFAULT	1	1	Takeoff	MaxTakeoff	8				
A 300B4-203	DEFAULT	1	2	Climb	MaxTakeoff	8	1 000			
A 300B4-203	DEFAULT	1	3	Accelerate	MaxTakeoff	8		2 440	169	

ACFTID	Profile_ID	Stage Length	Step Number	Step Type	Thrust Rating	Flap_ID	End Point Altitude (ft)	Rate Of Climb (ft/min)	End Point CAS (kt)	Accelerate_Percent (%)
A 300B4-203	DEFAULT	1	4	Accelerate	MaxTakeoff	1		1 830	189	
A 300B4-203	DEFAULT	1	5	Accelerate	MaxClimb	ZERO		1 000	209	
A 300B4-203	DEFAULT	1	6	Climb	MaxClimb	ZERO	3 000			
A 300B4-203	DEFAULT	1	7	Accelerate	MaxClimb	ZERO		1 000	250	
A 300B4-203	DEFAULT	1	8	Climb	MaxClimb	ZERO	5 500			
A 300B4-203	DEFAULT	1	9	Climb	MaxClimb	ZERO	7 500			
A 300B4-203	DEFAULT	1	10	Climb	MaxClimb	ZERO	10 000			
A 300B4-203	DEFAULT	2	1	Takeoff	MaxTakeoff	8				
A 300B4-203	DEFAULT	2	2	Climb	MaxTakeoff	8	1 000			
A 300B4-203	DEFAULT	2	3	Accelerate	MaxTakeoff	8		2 268	174	
A 300B4-203	DEFAULT	2	4	Accelerate	MaxTakeoff	1		1 701	194	
A 300B4-203	DEFAULT	2	5	Accelerate	MaxClimb	ZERO		1 000	214	
A 300B4-203	DEFAULT	2	6	Climb	MaxClimb	ZERO	3 000			
A 300B4-203	DEFAULT	2	7	Accelerate	MaxClimb	ZERO		1 000	250	
A 300B4-203	DEFAULT	2	8	Climb	MaxClimb	ZERO	5 500			
A 300B4-203	DEFAULT	2	9	Climb	MaxClimb	ZERO	7 500			
A 300B4-203	DEFAULT	2	10	Climb	MaxClimb	ZERO	10 000			
A 300B4-203	DEFAULT	3	1	Takeoff	MaxTakeoff	8				
A 300B4-203	DEFAULT	3	2	Climb	MaxTakeoff	8	1 000			
A 300B4-203	DEFAULT	3	3	Accelerate	MaxTakeoff	8		2 137	178	

ACFTID	Profile_ID	Stage Length	Step Number	Step Type	Thrust Rating	Flap_ID	End Point Altitude (ft)	Rate Of Climb (ft/min)	End Point CAS (kt)	Accelerate_Percent (%)
A 300B4-203	DEFAULT	3	4	Accelerate	MaxTakeoff	1		1 603	198	
A 300B4-203	DEFAULT	3	5	Accelerate	MaxClimb	ZERO		1 000	218	
A 300B4-203	DEFAULT	3	6	Climb	MaxClimb	ZERO	3 000			
A 300B4-203	DEFAULT	3	7	Accelerate	MaxClimb	ZERO		1 000	250	
A 300B4-203	DEFAULT	3	8	Climb	MaxClimb	ZERO	5 500			
A 300B4-203	DEFAULT	3	9	Climb	MaxClimb	ZERO	7 500			
A 300B4-203	DEFAULT	3	10	Climb	MaxClimb	ZERO	10 000			
A 300B4-203	DEFAULT	4	1	Takeoff	MaxTakeoff	8				
A 300B4-203	DEFAULT	4	2	Climb	MaxTakeoff	8	1 000			
A 300B4-203	DEFAULT	4	3	Accelerate	MaxTakeoff	8		1 912	186	
A 300B4-203	DEFAULT	4	4	Accelerate	MaxTakeoff	1		1 434	206	
A 300B4-203	DEFAULT	4	5	Accelerate	MaxClimb	ZERO		1 000	226	
A 300B4-203	DEFAULT	4	6	Climb	MaxClimb	ZERO	3 000			
A 300B4-203	DEFAULT	4	7	Accelerate	MaxClimb	ZERO		1 000	250	
A 300B4-203	DEFAULT	4	8	Climb	MaxClimb	ZERO	5 500			
A 300B4-203	DEFAULT	4	9	Climb	MaxClimb	ZERO	7 500			
A 300B4-203	DEFAULT	4	10	Climb	MaxClimb	ZERO	10 000			
A 300B4-203	DEFAULT	5	1	Takeoff	MaxTakeoff	8				
A 300B4-203	DEFAULT	5	2	Climb	MaxTakeoff	8	1 000			
A 300B4-203	DEFAULT	5	3	Accelerate	MaxTakeoff	8		1 688	194	

ACFTID	Profile_ID	Stage Length	Step Number	Step Type	Thrust Rating	Flap_ID	End Point Altitude (ft)	Rate Of Climb (ft/min)	End Point CAS (kt)	Accelerate_Percent (%)
A 300B4-203	DEFAULT	5	4	Accelerate	MaxTakeoff	1		1 266	214	
A 300B4-203	DEFAULT	5	5	Accelerate	MaxClimb	ZERO		1 000	234	
A 300B4-203	DEFAULT	5	6	Climb	MaxClimb	ZERO	3 000			
A 300B4-203	DEFAULT	5	7	Accelerate	MaxClimb	ZERO		1 000	250	
A 300B4-203	DEFAULT	5	8	Climb	MaxClimb	ZERO	5 500			
A 300B4-203	DEFAULT	5	9	Climb	MaxClimb	ZERO	7 500			
A 300B4-203	DEFAULT	5	10	Climb	MaxClimb	ZERO	10 000			
A 310-304	DEFAULT	1	1	Takeoff	MaxTakeoff	1 500				
A 310-304	DEFAULT	1	2	Climb	MaxTakeoff	1 500	1 000			
A 310-304	DEFAULT	1	3	Accelerate	MaxTakeoff	1 500		1 475,7	179,5	
A 310-304	DEFAULT	1	4	Climb	MaxClimb	0	3 000			
A 310-304	DEFAULT	1	5	Accelerate	MaxClimb	0		1 454,9	250	
A 310-304	DEFAULT	1	6	Climb	MaxClimb	0	5 500			
A 310-304	DEFAULT	1	7	Climb	MaxClimb	0	7 500			
A 310-304	DEFAULT	1	8	Climb	MaxClimb	0	10 000			
A 310-304	DEFAULT	2	1	Takeoff	MaxTakeoff	1 500				
A 310-304	DEFAULT	2	2	Climb	MaxTakeoff	1 500	1 000			
A 310-304	DEFAULT	2	3	Accelerate	MaxTakeoff	1 500		1 415,7	183	
A 310-304	DEFAULT	2	4	Climb	MaxClimb	0	3 000			
A 310-304	DEFAULT	2	5	Accelerate	MaxClimb	0		1 392,7	250	

ACFTID	Profile_ID	Stage Length	Step Number	Step Type	Thrust Rating	Flap_ID	End Point Altitude (ft)	Rate Of Climb (ft/min)	End Point CAS (kt)	Accelerate_Percent (%)
A310-304	DEFAULT	2	6	Climb	MaxClimb	0	5 500			
A310-304	DEFAULT	2	7	Climb	MaxClimb	0	7 500			
A310-304	DEFAULT	2	8	Climb	MaxClimb	0	10 000			
A310-304	DEFAULT	3	1	Takeoff	MaxTakeoff	1 500				
A310-304	DEFAULT	3	2	Climb	MaxTakeoff	1 500	1 000			
A310-304	DEFAULT	3	3	Accelerate	MaxTakeoff	1 500		1 357	186,6	
A310-304	DEFAULT	3	4	Climb	MaxClimb	0	3 000			
A310-304	DEFAULT	3	5	Accelerate	MaxClimb	0		1 332,3	250	
A310-304	DEFAULT	3	6	Climb	MaxClimb	0	5 500			
A310-304	DEFAULT	3	7	Climb	MaxClimb	0	7 500			
A310-304	DEFAULT	3	8	Climb	MaxClimb	0	10 000			
A310-304	DEFAULT	4	1	Takeoff	MaxTakeoff	1 500				
A310-304	DEFAULT	4	2	Climb	MaxTakeoff	1 500	1 000			
A310-304	DEFAULT	4	3	Accelerate	MaxTakeoff	1 500		1 262,8	192,8	
A310-304	DEFAULT	4	4	Climb	MaxClimb	0	3 000			
A310-304	DEFAULT	4	5	Accelerate	MaxClimb	0		1 234,1	250	
A310-304	DEFAULT	4	6	Climb	MaxClimb	0	5 500			
A310-304	DEFAULT	4	7	Climb	MaxClimb	0	7 500			
A310-304	DEFAULT	4	8	Climb	MaxClimb	0	10 000			
A310-304	DEFAULT	5	1	Takeoff	MaxTakeoff	1 500				

ACFTID	Profile_ID	Stage Length	Step Number	Step Type	Thrust Rating	Flap_ID	End Point Altitude (ft)	Rate Of Climb (ft/min)	End Point CAS (kt)	Accelerate_Percent (%)
A310-304	DEFAULT	5	2	Climb	MaxTakeoff	1 500	1 000			
A310-304	DEFAULT	5	3	Accelerate	MaxTakeoff	1 500		1 151,8	200,9	
A310-304	DEFAULT	5	4	Climb	MaxClimb	0	3 000			
A310-304	DEFAULT	5	5	Accelerate	MaxClimb	0		1 117,9	250	
A310-304	DEFAULT	5	6	Climb	MaxClimb	0	5 500			
A310-304	DEFAULT	5	7	Climb	MaxClimb	0	7 500			
A310-304	DEFAULT	5	8	Climb	MaxClimb	0	10 000			
A310-304	DEFAULT	6	1	Takeoff	MaxTakeoff	1 500				
A310-304	DEFAULT	6	2	Climb	MaxTakeoff	1 500	1 000			
A310-304	DEFAULT	6	3	Accelerate	MaxTakeoff	1 500		990,5	214,3	
A310-304	DEFAULT	6	4	Climb	MaxClimb	0	3 000			
A310-304	DEFAULT	6	5	Accelerate	MaxClimb	0		944,8	250	
A310-304	DEFAULT	6	6	Climb	MaxClimb	0	5 500			
A310-304	DEFAULT	6	7	Climb	MaxClimb	0	7 500			
A310-304	DEFAULT	6	8	Climb	MaxClimb	0	10 000			
A310-304	ICAO_A	1	1	Takeoff	MaxTakeoff	1 500				
A310-304	ICAO_A	1	2	Climb	MaxTakeoff	1 500	1 500			
A310-304	ICAO_A	1	3	Climb	MaxClimb	1 500	3 000			
A310-304	ICAO_A	1	4	Accelerate	MaxClimb	1 500		1 167,6	179,4	
A310-304	ICAO_A	1	5	Accelerate	MaxClimb	0		1 273,6	200,4	

ACFTID	Profile_ID	Stage Length	Step Number	Step Type	Thrust Rating	Flap_ID	End Point Altitude (ft)	Rate Of Climb (ft/min)	End Point CAS (kt)	Accelerate_Percent (%)
A310-304	ICAO_A	1	6	Accelerate	MaxClimb	0		1 496,6	250	
A310-304	ICAO_A	1	7	Climb	MaxClimb	0	5 500			
A310-304	ICAO_A	1	8	Climb	MaxClimb	0	7 500			
A310-304	ICAO_A	1	9	Climb	MaxClimb	0	10 000			
A310-304	ICAO_A	2	1	Takeoff	MaxTakeoff	1 500				
A310-304	ICAO_A	2	2	Climb	MaxTakeoff	1 500	1 500			
A310-304	ICAO_A	2	3	Climb	MaxClimb	1 500	3 000			
A310-304	ICAO_A	2	4	Accelerate	MaxClimb	1 500		1 115,8	182,9	
A310-304	ICAO_A	2	5	Accelerate	MaxClimb	0		1 222,3	202,8	
A310-304	ICAO_A	2	6	Accelerate	MaxClimb	0		1 430,5	250	
A310-304	ICAO_A	2	7	Climb	MaxClimb	0	5 500			
A310-304	ICAO_A	2	8	Climb	MaxClimb	0	7 500			
A310-304	ICAO_A	2	9	Climb	MaxClimb	0	10 000			
A310-304	ICAO_A	3	1	Takeoff	MaxTakeoff	1 500				
A310-304	ICAO_A	3	2	Climb	MaxTakeoff	1 500	1 500			
A310-304	ICAO_A	3	3	Climb	MaxClimb	1 500	3 000			
A310-304	ICAO_A	3	4	Accelerate	MaxClimb	1 500		1 065,4	186,5	
A310-304	ICAO_A	3	5	Accelerate	MaxClimb	0		1 172,6	205,3	
A310-304	ICAO_A	3	6	Accelerate	MaxClimb	0		1 366,6	250	
A310-304	ICAO_A	3	7	Climb	MaxClimb	0	5 500			

ACFTID	Profile_ID	Stage Length	Step Number	Step Type	Thrust Rating	Flap_ID	End Point Altitude (ft)	Rate Of Climb (ft/min)	End Point CAS (kt)	Accelerate_Percent (%)
A310-304	ICAO_A	3	8	Climb	MaxClimb	0	7 500			
A310-304	ICAO_A	3	9	Climb	MaxClimb	0	10 000			
A310-304	ICAO_A	4	1	Takeoff	MaxTakeoff	1 500				
A310-304	ICAO_A	4	2	Climb	MaxTakeoff	1 500	1 500			
A310-304	ICAO_A	4	3	Climb	MaxClimb	1 500	3 000			
A310-304	ICAO_A	4	4	Accelerate	MaxClimb	1 500		984,3	192,7	
A310-304	ICAO_A	4	5	Accelerate	MaxClimb	0		1 091,4	209,7	
A310-304	ICAO_A	4	6	Accelerate	MaxClimb	0		1 262,9	250	
A310-304	ICAO_A	4	7	Climb	MaxClimb	0	5 500			
A310-304	ICAO_A	4	8	Climb	MaxClimb	0	7 500			
A310-304	ICAO_A	4	9	Climb	MaxClimb	0	10 000			
A310-304	ICAO_A	5	1	Takeoff	MaxTakeoff	1 500				
A310-304	ICAO_A	5	2	Climb	MaxTakeoff	1 500	1 500			
A310-304	ICAO_A	5	3	Climb	MaxClimb	1 500	3 000			
A310-304	ICAO_A	5	4	Accelerate	MaxClimb	1 500		888,4	200,8	
A310-304	ICAO_A	5	5	Accelerate	MaxClimb	0		994,5	215,7	
A310-304	ICAO_A	5	6	Accelerate	MaxClimb	0		1 140,7	250	
A310-304	ICAO_A	5	7	Climb	MaxClimb	0	5 500			
A310-304	ICAO_A	5	8	Climb	MaxClimb	0	7 500			
A310-304	ICAO_A	5	9	Climb	MaxClimb	0	10 000			

ACFTID	Profile_ID	Stage Length	Step Number	Step Type	Thrust Rating	Flap_ID	End Point Altitude (ft)	Rate Of Climb (ft/min)	End Point CAS (kt)	Accelerate_Percent (%)
A310-304	ICAO_A	6	1	Takeoff	MaxTakeoff	1 500				
A310-304	ICAO_A	6	2	Climb	MaxTakeoff	1 500	1 500			
A310-304	ICAO_A	6	3	Climb	MaxClimb	1 500	3 000			
A310-304	ICAO_A	6	4	Accelerate	MaxClimb	1 500		747,4	214,2	
A310-304	ICAO_A	6	5	Accelerate	MaxClimb	0		848,6	226,2	
A310-304	ICAO_A	6	6	Accelerate	MaxClimb	0		959,5	250	
A310-304	ICAO_A	6	7	Climb	MaxClimb	0	5 500			
A310-304	ICAO_A	6	8	Climb	MaxClimb	0	7 500			
A310-304	ICAO_A	6	9	Climb	MaxClimb	0	10 000			
A310-304	ICAO_B	1	1	Takeoff	MaxTakeoff	1 500				
A310-304	ICAO_B	1	2	Climb	MaxTakeoff	1 500	1 000			
A310-304	ICAO_B	1	3	Accelerate	MaxTakeoff	1 500		1 475,7	179,5	
A310-304	ICAO_B	1	4	Climb	MaxClimb	0	3 000			
A310-304	ICAO_B	1	5	Accelerate	MaxClimb	0		1 454,9	250	
A310-304	ICAO_B	1	6	Climb	MaxClimb	0	5 500			
A310-304	ICAO_B	1	7	Climb	MaxClimb	0	7 500			
A310-304	ICAO_B	1	8	Climb	MaxClimb	0	10 000			
A310-304	ICAO_B	2	1	Takeoff	MaxTakeoff	1 500				
A310-304	ICAO_B	2	2	Climb	MaxTakeoff	1 500	1 000			
A310-304	ICAO_B	2	3	Accelerate	MaxTakeoff	1 500		1 415,7	183	

ACFTID	Profile_ID	Stage Length	Step Number	Step Type	Thrust Rating	Flap_ID	End Point Altitude (ft)	Rate Of Climb (ft/min)	End Point CAS (kt)	Accelerate_Percent (%)
A310-304	ICAO_B	2	4	Climb	MaxClimb	0	3 000			
A310-304	ICAO_B	2	5	Accelerate	MaxClimb	0		1 392,7	250	
A310-304	ICAO_B	2	6	Climb	MaxClimb	0	5 500			
A310-304	ICAO_B	2	7	Climb	MaxClimb	0	7 500			
A310-304	ICAO_B	2	8	Climb	MaxClimb	0	10 000			
A310-304	ICAO_B	3	1	Takeoff	MaxTakeoff	1 500				
A310-304	ICAO_B	3	2	Climb	MaxTakeoff	1 500	1 000			
A310-304	ICAO_B	3	3	Accelerate	MaxTakeoff	1 500		1 357	186,6	
A310-304	ICAO_B	3	4	Climb	MaxClimb	0	3 000			
A310-304	ICAO_B	3	5	Accelerate	MaxClimb	0		1 332,3	250	
A310-304	ICAO_B	3	6	Climb	MaxClimb	0	5 500			
A310-304	ICAO_B	3	7	Climb	MaxClimb	0	7 500			
A310-304	ICAO_B	3	8	Climb	MaxClimb	0	10 000			
A310-304	ICAO_B	4	1	Takeoff	MaxTakeoff	1 500				
A310-304	ICAO_B	4	2	Climb	MaxTakeoff	1 500	1 000			
A310-304	ICAO_B	4	3	Accelerate	MaxTakeoff	1 500		1 262,8	192,8	
A310-304	ICAO_B	4	4	Climb	MaxClimb	0	3 000			
A310-304	ICAO_B	4	5	Accelerate	MaxClimb	0		1 234,1	250	
A310-304	ICAO_B	4	6	Climb	MaxClimb	0	5 500			
A310-304	ICAO_B	4	7	Climb	MaxClimb	0	7 500			

ACFTID	Profile_ID	Stage Length	Step Number	Step Type	Thrust Rating	Flap_ID	End Point Altitude (ft)	Rate Of Climb (ft/min)	End Point CAS (kt)	Accelerate_Percent (%)
A310-304	ICAO_B	4	8	Climb	MaxClimb	0	10 000			
A310-304	ICAO_B	5	1	Takeoff	MaxTakeoff	1 500				
A310-304	ICAO_B	5	2	Climb	MaxTakeoff	1 500	1 000			
A310-304	ICAO_B	5	3	Accelerate	MaxTakeoff	1 500		1 151,8	200,9	
A310-304	ICAO_B	5	4	Climb	MaxClimb	0	3 000			
A310-304	ICAO_B	5	5	Accelerate	MaxClimb	0		1 117,9	250	
A310-304	ICAO_B	5	6	Climb	MaxClimb	0	5 500			
A310-304	ICAO_B	5	7	Climb	MaxClimb	0	7 500			
A310-304	ICAO_B	5	8	Climb	MaxClimb	0	10 000			
A310-304	ICAO_B	6	1	Takeoff	MaxTakeoff	1 500				
A310-304	ICAO_B	6	2	Climb	MaxTakeoff	1 500	1 000			
A310-304	ICAO_B	6	3	Accelerate	MaxTakeoff	1 500		990,5	214,3	
A310-304	ICAO_B	6	4	Climb	MaxClimb	0	3 000			
A310-304	ICAO_B	6	5	Accelerate	MaxClimb	0		944,8	250	
A310-304	ICAO_B	6	6	Climb	MaxClimb	0	5 500			
A310-304	ICAO_B	6	7	Climb	MaxClimb	0	7 500			
A310-304	ICAO_B	6	8	Climb	MaxClimb	0	10 000			
A319-131	DEFAULT	1	1	Takeoff	MaxTakeoff	1+F				
A319-131	DEFAULT	1	2	Climb	MaxTakeoff	1+F	1 000			
A319-131	DEFAULT	1	3	Accelerate	MaxTakeoff	1+F		1 042,6	181,6	

ACFTID	Profile_ID	Stage Length	Step Number	Step Type	Thrust Rating	Flap_ID	End Point Altitude (ft)	Rate Of Climb (ft/min)	End Point CAS (kt)	Accelerate_Percent (%)
A319-131	DEFAULT	1	4	Accelerate	MaxTakeoff	1		1 177,5	200,7	
A319-131	DEFAULT	1	5	Climb	MaxClimb	ZERO	3 000			
A319-131	DEFAULT	1	6	Accelerate	MaxClimb	ZERO		1 320,8	250	
A319-131	DEFAULT	1	7	Climb	MaxClimb	ZERO	5 500			
A319-131	DEFAULT	1	8	Climb	MaxClimb	ZERO	7 500			
A319-131	DEFAULT	1	9	Climb	MaxClimb	ZERO	10 000			
A319-131	DEFAULT	2	1	Takeoff	MaxTakeoff	1+F				
A319-131	DEFAULT	2	2	Climb	MaxTakeoff	1+F	1 000			
A319-131	DEFAULT	2	3	Accelerate	MaxTakeoff	1+F		997,1	185,3	
A319-131	DEFAULT	2	4	Accelerate	MaxTakeoff	1		1 128,9	203,3	
A319-131	DEFAULT	2	5	Climb	MaxClimb	ZERO	3 000			
A319-131	DEFAULT	2	6	Accelerate	MaxClimb	ZERO		1 264	250	
A319-131	DEFAULT	2	7	Climb	MaxClimb	ZERO	5 500			
A319-131	DEFAULT	2	8	Climb	MaxClimb	ZERO	7 500			
A319-131	DEFAULT	2	9	Climb	MaxClimb	ZERO	10 000			
A319-131	DEFAULT	3	1	Takeoff	MaxTakeoff	1+F				
A319-131	DEFAULT	3	2	Climb	MaxTakeoff	1+F	1 000			
A319-131	DEFAULT	3	3	Accelerate	MaxTakeoff	1+F		952,7	189	
A319-131	DEFAULT	3	4	Accelerate	MaxTakeoff	1		1 081	206	
A319-131	DEFAULT	3	5	Climb	MaxClimb	ZERO	3 000			

ACFTID	Profile_ID	Stage Length	Step Number	Step Type	Thrust Rating	Flap_ID	End Point Altitude (ft)	Rate Of Climb (ft/min)	End Point CAS (kt)	Accelerate_Percent (%)
A319-131	DEFAULT	3	6	Accelerate	MaxClimb	ZERO		1 208,7	250	
A319-131	DEFAULT	3	7	Climb	MaxClimb	ZERO	5 500			
A319-131	DEFAULT	3	8	Climb	MaxClimb	ZERO	7 500			
A319-131	DEFAULT	3	9	Climb	MaxClimb	ZERO	10 000			
A319-131	DEFAULT	4	1	Takeoff	MaxTakeoff	1+F				
A319-131	DEFAULT	4	2	Climb	MaxTakeoff	1+F	1 000			
A319-131	DEFAULT	4	3	Accelerate	MaxTakeoff	1+F		880,8	195,6	
A319-131	DEFAULT	4	4	Accelerate	MaxTakeoff	1		1 001,7	210,8	
A319-131	DEFAULT	4	5	Climb	MaxClimb	ZERO	3 000			
A319-131	DEFAULT	4	6	Accelerate	MaxClimb	ZERO		1 119,6	250	
A319-131	DEFAULT	4	7	Climb	MaxClimb	ZERO	5 500			
A319-131	DEFAULT	4	8	Climb	MaxClimb	ZERO	7 500			
A319-131	DEFAULT	4	9	Climb	MaxClimb	ZERO	10 000			
A319-131	DEFAULT	5	1	Takeoff	MaxTakeoff	1+F				
A319-131	DEFAULT	5	2	Accelerate	MaxTakeoff	1+F		735,2	169,7	
A319-131	DEFAULT	5	3	Climb	MaxTakeoff	1+F	1 000			
A319-131	DEFAULT	5	4	Accelerate	MaxTakeoff	1+F		793,4	208,8	
A319-131	DEFAULT	5	5	Accelerate	MaxTakeoff	ZERO		860	221,2	
A319-131	DEFAULT	5	6	Climb	MaxClimb	ZERO	3 000			
A319-131	DEFAULT	5	7	Accelerate	MaxClimb	ZERO		964,2	250	

ACFTID	Profile_ID	Stage Length	Step Number	Step Type	Thrust Rating	Flap_ID	End Point Altitude (ft)	Rate Of Climb (ft/min)	End Point CAS (kt)	Accelerate_Percent (%)
A319-131	DEFAULT	5	8	Climb	MaxClimb	ZERO	5 500			
A319-131	DEFAULT	5	9	Climb	MaxClimb	ZERO	7 500			
A319-131	DEFAULT	5	10	Climb	MaxClimb	ZERO	10 000			
A319-131	ICAO_A	1	1	Takeoff	MaxTakeoff	1+F				
A319-131	ICAO_A	1	2	Climb	MaxTakeoff	1+F	1 500			
A319-131	ICAO_A	1	3	Climb	MaxClimb	1+F	3 000			
A319-131	ICAO_A	1	4	Accelerate	MaxClimb	1+F		822,7	181,4	
A319-131	ICAO_A	1	5	Accelerate	MaxClimb	1		972,3	196,5	
A319-131	ICAO_A	1	6	Accelerate	MaxClimb	ZERO		1 162,8	223,8	
A319-131	ICAO_A	1	7	Accelerate	MaxClimb	ZERO		1 374,2	250	
A319-131	ICAO_A	1	8	Climb	MaxClimb	ZERO	5 500			
A319-131	ICAO_A	1	9	Climb	MaxClimb	ZERO	7 500			
A319-131	ICAO_A	1	10	Climb	MaxClimb	ZERO	10 000			
A319-131	ICAO_A	2	1	Takeoff	MaxTakeoff	1+F				
A319-131	ICAO_A	2	2	Climb	MaxTakeoff	1+F	1 500			
A319-131	ICAO_A	2	3	Climb	MaxClimb	1+F	3 000			
A319-131	ICAO_A	2	4	Accelerate	MaxClimb	1+F		786,5	185,2	
A319-131	ICAO_A	2	5	Accelerate	MaxClimb	1		935,4	199,4	
A319-131	ICAO_A	2	6	Accelerate	MaxClimb	ZERO		1 115,9	225,3	
A319-131	ICAO_A	2	7	Accelerate	MaxClimb	ZERO		1 312,1	250	

ACFTID	Profile_ID	Stage Length	Step Number	Step Type	Thrust Rating	Flap_ID	End Point Altitude (ft)	Rate Of Climb (ft/min)	End Point CAS (kt)	Accelerate_Percent (%)
A319-131	ICAO_A	2	8	Climb	MaxClimb	ZERO	5 500			
A319-131	ICAO_A	2	9	Climb	MaxClimb	ZERO	7 500			
A319-131	ICAO_A	2	10	Climb	MaxClimb	ZERO	10 000			
A319-131	ICAO_A	3	1	Takeoff	MaxTakeoff	1+F				
A319-131	ICAO_A	3	2	Climb	MaxTakeoff	1+F	1 500			
A319-131	ICAO_A	3	3	Climb	MaxClimb	1+F	3 000			
A319-131	ICAO_A	3	4	Accelerate	MaxClimb	1+F		751,1	188,9	
A319-131	ICAO_A	3	5	Accelerate	MaxClimb	1		899,4	202,4	
A319-131	ICAO_A	3	6	Accelerate	MaxClimb	ZERO		1 070,2	226,9	
A319-131	ICAO_A	3	7	Accelerate	MaxClimb	ZERO		1 252	250	
A319-131	ICAO_A	3	8	Climb	MaxClimb	ZERO	5 500			
A319-131	ICAO_A	3	9	Climb	MaxClimb	ZERO	7 500			
A319-131	ICAO_A	3	10	Climb	MaxClimb	ZERO	10 000			
A319-131	ICAO_A	4	1	Takeoff	MaxTakeoff	1+F				
A319-131	ICAO_A	4	2	Climb	MaxTakeoff	1+F	1 500			
A319-131	ICAO_A	4	3	Climb	MaxClimb	1+F	3 000			
A319-131	ICAO_A	4	4	Accelerate	MaxClimb	1+F		693,7	195,4	
A319-131	ICAO_A	4	5	Accelerate	MaxClimb	1		840,2	207,6	
A319-131	ICAO_A	4	6	Accelerate	MaxClimb	ZERO		996,8	230	
A319-131	ICAO_A	4	7	Accelerate	MaxClimb	ZERO		1 155,3	250	

ACFTID	Profile_ID	Stage Length	Step Number	Step Type	Thrust Rating	Flap_ID	End Point Altitude (ft)	Rate Of Climb (ft/min)	End Point CAS (kt)	Accelerate_Percent (%)
A319-131	ICAO_A	4	8	Climb	MaxClimb	ZERO	5 500			
A319-131	ICAO_A	4	9	Climb	MaxClimb	ZERO	7 500			
A319-131	ICAO_A	4	10	Climb	MaxClimb	ZERO	10 000			
A319-131	ICAO_A	5	1	Takeoff	MaxTakeoff	1+F				
A319-131	ICAO_A	5	2	Accelerate	MaxTakeoff	1+F		735,2	169,7	
A319-131	ICAO_A	5	3	Climb	MaxTakeoff	1+F	1 500			
A319-131	ICAO_A	5	4	Climb	MaxClimb	1+F	3 000			
A319-131	ICAO_A	5	5	Accelerate	MaxClimb	1+F		637,2	208,7	
A319-131	ICAO_A	5	6	Accelerate	MaxClimb	1		733,4	218,7	
A319-131	ICAO_A	5	7	Accelerate	MaxClimb	ZERO		869,2	237,4	
A319-131	ICAO_A	5	8	Accelerate	MaxClimb	ZERO		987,8	250	
A319-131	ICAO_A	5	9	Climb	MaxClimb	ZERO	5 500			
A319-131	ICAO_A	5	10	Climb	MaxClimb	ZERO	7 500			
A319-131	ICAO_A	5	11	Climb	MaxClimb	ZERO	10 000			
A319-131	ICAO_B	1	1	Takeoff	MaxTakeoff	1+F				
A319-131	ICAO_B	1	2	Climb	MaxTakeoff	1+F	1 000			
A319-131	ICAO_B	1	3	Accelerate	MaxTakeoff	1+F		1 042,6	181,6	
A319-131	ICAO_B	1	4	Accelerate	MaxTakeoff	1		1 177,5	200,7	
A319-131	ICAO_B	1	5	Climb	MaxClimb	ZERO	3 000			
A319-131	ICAO_B	1	6	Accelerate	MaxClimb	ZERO		1 320,8	250	

ACFTID	Profile_ID	Stage Length	Step Number	Step Type	Thrust Rating	Flap_ID	End Point Altitude (ft)	Rate Of Climb (ft/min)	End Point CAS (kt)	Accelerate_Percent (%)
A319-131	ICAO_B	1	7	Climb	MaxClimb	ZERO	5 500			
A319-131	ICAO_B	1	8	Climb	MaxClimb	ZERO	7 500			
A319-131	ICAO_B	1	9	Climb	MaxClimb	ZERO	10 000			
A319-131	ICAO_B	2	1	Takeoff	MaxTakeoff	1+F				
A319-131	ICAO_B	2	2	Climb	MaxTakeoff	1+F	1 000			
A319-131	ICAO_B	2	3	Accelerate	MaxTakeoff	1+F		997,1	185,3	
A319-131	ICAO_B	2	4	Accelerate	MaxTakeoff	1		1 128,9	203,3	
A319-131	ICAO_B	2	5	Climb	MaxClimb	ZERO	3 000			
A319-131	ICAO_B	2	6	Accelerate	MaxClimb	ZERO		1 264	250	
A319-131	ICAO_B	2	7	Climb	MaxClimb	ZERO	5 500			
A319-131	ICAO_B	2	8	Climb	MaxClimb	ZERO	7 500			
A319-131	ICAO_B	2	9	Climb	MaxClimb	ZERO	10 000			
A319-131	ICAO_B	3	1	Takeoff	MaxTakeoff	1+F				
A319-131	ICAO_B	3	2	Climb	MaxTakeoff	1+F	1 000			
A319-131	ICAO_B	3	3	Accelerate	MaxTakeoff	1+F		952,7	189	
A319-131	ICAO_B	3	4	Accelerate	MaxTakeoff	1		1 081	206	
A319-131	ICAO_B	3	5	Climb	MaxClimb	ZERO	3 000			
A319-131	ICAO_B	3	6	Accelerate	MaxClimb	ZERO		1 208,7	250	
A319-131	ICAO_B	3	7	Climb	MaxClimb	ZERO	5 500			
A319-131	ICAO_B	3	8	Climb	MaxClimb	ZERO	7 500			

ACFTID	Profile_ID	Stage Length	Step Number	Step Type	Thrust Rating	Flap_ID	End Point Altitude (ft)	Rate Of Climb (ft/min)	End Point CAS (kt)	Accelerate_Percent (%)
A319-131	ICAO_B	3	9	Climb	MaxClimb	ZERO	10 000			
A319-131	ICAO_B	4	1	Takeoff	MaxTakeoff	1+F				
A319-131	ICAO_B	4	2	Climb	MaxTakeoff	1+F	1 000			
A319-131	ICAO_B	4	3	Accelerate	MaxTakeoff	1+F		880,8	195,6	
A319-131	ICAO_B	4	4	Accelerate	MaxTakeoff	1		1 001,7	210,8	
A319-131	ICAO_B	4	5	Climb	MaxClimb	ZERO	3 000			
A319-131	ICAO_B	4	6	Accelerate	MaxClimb	ZERO		1 119,6	250	
A319-131	ICAO_B	4	7	Climb	MaxClimb	ZERO	5 500			
A319-131	ICAO_B	4	8	Climb	MaxClimb	ZERO	7 500			
A319-131	ICAO_B	4	9	Climb	MaxClimb	ZERO	10 000			
A319-131	ICAO_B	5	1	Takeoff	MaxTakeoff	1+F				
A319-131	ICAO_B	5	2	Accelerate	MaxTakeoff	1+F		735,2	169,7	
A319-131	ICAO_B	5	3	Climb	MaxTakeoff	1+F	1 000			
A319-131	ICAO_B	5	4	Accelerate	MaxTakeoff	1+F		793,4	208,8	
A319-131	ICAO_B	5	5	Accelerate	MaxTakeoff	ZERO		860	221,2	
A319-131	ICAO_B	5	6	Climb	MaxClimb	ZERO	3 000			
A319-131	ICAO_B	5	7	Accelerate	MaxClimb	ZERO		964,2	250	
A319-131	ICAO_B	5	8	Climb	MaxClimb	ZERO	5 500			
A319-131	ICAO_B	5	9	Climb	MaxClimb	ZERO	7 500			
A319-131	ICAO_B	5	10	Climb	MaxClimb	ZERO	10 000			

ACFTID	Profile_ID	Stage Length	Step Number	Step Type	Thrust Rating	Flap_ID	End Point Altitude (ft)	Rate Of Climb (ft/min)	End Point CAS (kt)	Accelerate_Percent (%)
A 320-211	DEFAULT	1	1	Takeoff	MaxTakeoff	1+F				
A 320-211	DEFAULT	1	2	Climb	MaxTakeoff	1+F	1 000			
A 320-211	DEFAULT	1	3	Accelerate	MaxTakeoff	1+F		1 150,5	186,2	
A 320-211	DEFAULT	1	4	Accelerate	MaxTakeoff	1		1 300,7	208,1	
A 320-211	DEFAULT	1	5	Climb	MaxClimb	ZERO	3 000			
A 320-211	DEFAULT	1	6	Accelerate	MaxClimb	ZERO		1 230,7	250	
A 320-211	DEFAULT	1	7	Climb	MaxClimb	ZERO	5 500			
A 320-211	DEFAULT	1	8	Climb	MaxClimb	ZERO	7 500			
A 320-211	DEFAULT	1	9	Climb	MaxClimb	ZERO	10 000			
A 320-211	DEFAULT	2	1	Takeoff	MaxTakeoff	1+F				
A 320-211	DEFAULT	2	2	Climb	MaxTakeoff	1+F	1 000			
A 320-211	DEFAULT	2	3	Accelerate	MaxTakeoff	1+F		1 098,5	190,2	
A 320-211	DEFAULT	2	4	Accelerate	MaxTakeoff	1		1 243,7	210,7	
A 320-211	DEFAULT	2	5	Climb	MaxClimb	ZERO	3 000			
A 320-211	DEFAULT	2	6	Accelerate	MaxClimb	ZERO		1 171	250	
A 320-211	DEFAULT	2	7	Climb	MaxClimb	ZERO	5 500			
A 320-211	DEFAULT	2	8	Climb	MaxClimb	ZERO	7 500			
A 320-211	DEFAULT	2	9	Climb	MaxClimb	ZERO	10 000			
A 320-211	DEFAULT	3	1	Takeoff	MaxTakeoff	1+F				
A 320-211	DEFAULT	3	2	Climb	MaxTakeoff	1+F	1 000			

ACFTID	Profile_ID	Stage Length	Step Number	Step Type	Thrust Rating	Flap_ID	End Point Altitude (ft)	Rate Of Climb (ft/min)	End Point CAS (kt)	Accelerate_Percent (%)
A 320-211	DEFAULT	3	3	Accelerate	MaxTakeoff	1+F		1 049,6	194,3	
A 320-211	DEFAULT	3	4	Accelerate	MaxTakeoff	1		1 189,2	213,5	
A 320-211	DEFAULT	3	5	Climb	MaxClimb	ZERO	3 000			
A 320-211	DEFAULT	3	6	Accelerate	MaxClimb	ZERO		1 113,9	250	
A 320-211	DEFAULT	3	7	Climb	MaxClimb	ZERO	5 500			
A 320-211	DEFAULT	3	8	Climb	MaxClimb	ZERO	7 500			
A 320-211	DEFAULT	3	9	Climb	MaxClimb	ZERO	10 000			
A 320-211	DEFAULT	4	1	Takeoff	MaxTakeoff	1+F				
A 320-211	DEFAULT	4	2	Climb	MaxTakeoff	1+F	1 000			
A 320-211	DEFAULT	4	3	Accelerate	MaxTakeoff	1+F		972,6	201,4	
A 320-211	DEFAULT	4	4	Accelerate	MaxTakeoff	1		1 101	218,7	
A 320-211	DEFAULT	4	5	Climb	MaxClimb	ZERO	3 000			
A 320-211	DEFAULT	4	6	Accelerate	MaxClimb	ZERO		1 021	250	
A 320-211	DEFAULT	4	7	Climb	MaxClimb	ZERO	5 500			
A 320-211	DEFAULT	4	8	Climb	MaxClimb	ZERO	7 500			
A 320-211	DEFAULT	4	9	Climb	MaxClimb	ZERO	10 000			
A 320-211	DEFAULT	5	1	Takeoff	MaxTakeoff	1+F				
A 320-211	DEFAULT	5	2	Climb	MaxTakeoff	1+F	1 000			
A 320-211	DEFAULT	5	3	Accelerate	MaxTakeoff	1+F		933,1	205,1	
A 320-211	DEFAULT	5	4	Accelerate	MaxTakeoff	1		1 056	221,4	

ACFTID	Profile_ID	Stage Length	Step Number	Step Type	Thrust Rating	Flap_ID	End Point Altitude (ft)	Rate Of Climb (ft/min)	End Point CAS (kt)	Accelerate_Percent (%)
A 320-211	DEFAULT	5	5	Climb	MaxClimb	ZERO	3 000			
A 320-211	DEFAULT	5	6	Accelerate	MaxClimb	ZERO		973,2	250	
A 320-211	DEFAULT	5	7	Climb	MaxClimb	ZERO	5 500			
A 320-211	DEFAULT	5	8	Climb	MaxClimb	ZERO	7 500			
A 320-211	DEFAULT	5	9	Climb	MaxClimb	ZERO	10 000			
A 320-211	ICAO_A	1	1	Takeoff	MaxTakeoff	1+F				
A 320-211	ICAO_A	1	2	Climb	MaxTakeoff	1+F	1 500			
A 320-211	ICAO_A	1	3	Climb	MaxClimb	1+F	3 000			
A 320-211	ICAO_A	1	4	Accelerate	MaxClimb	1+F		812,1	186,1	
A 320-211	ICAO_A	1	5	Accelerate	MaxClimb	1		933,5	201,2	
A 320-211	ICAO_A	1	6	Accelerate	MaxClimb	ZERO		1 119,7	228,2	
A 320-211	ICAO_A	1	7	Accelerate	MaxClimb	ZERO		1 240,5	250	
A 320-211	ICAO_A	1	8	Climb	MaxClimb	ZERO	5 500			
A 320-211	ICAO_A	1	9	Climb	MaxClimb	ZERO	7 500			
A 320-211	ICAO_A	1	10	Climb	MaxClimb	ZERO	10 000			
A 320-211	ICAO_A	2	1	Takeoff	MaxTakeoff	1+F				
A 320-211	ICAO_A	2	2	Climb	MaxTakeoff	1+F	1 500			
A 320-211	ICAO_A	2	3	Climb	MaxClimb	1+F	3 000			
A 320-211	ICAO_A	2	4	Accelerate	MaxClimb	1+F		769,5	190,1	
A 320-211	ICAO_A	2	5	Accelerate	MaxClimb	1		899,8	204,3	

ACFTID	Profile_ID	Stage Length	Step Number	Step Type	Thrust Rating	Flap_ID	End Point Altitude (ft)	Rate Of Climb (ft/min)	End Point CAS (kt)	Accelerate_Percent (%)
A320-211	ICAO_A	2	6	Accelerate	MaxClimb	ZERO		1 069,9	229,9	
A320-211	ICAO_A	2	7	Accelerate	MaxClimb	ZERO		1 176,4	250	
A320-211	ICAO_A	2	8	Climb	MaxClimb	ZERO	5 500			
A320-211	ICAO_A	2	9	Climb	MaxClimb	ZERO	7 500			
A320-211	ICAO_A	2	10	Climb	MaxClimb	ZERO	10 000			
A320-211	ICAO_A	3	1	Takeoff	MaxTakeoff	1+F				
A320-211	ICAO_A	3	2	Climb	MaxTakeoff	1+F	1 500			
A320-211	ICAO_A	3	3	Climb	MaxClimb	1+F	3 000			
A320-211	ICAO_A	3	4	Accelerate	MaxClimb	1+F		730,3	194,1	
A320-211	ICAO_A	3	5	Accelerate	MaxClimb	1		868	207,6	
A320-211	ICAO_A	3	6	Accelerate	MaxClimb	ZERO		1 021,8	231,7	
A320-211	ICAO_A	3	7	Accelerate	MaxClimb	ZERO		1 115,4	250	
A320-211	ICAO_A	3	8	Climb	MaxClimb	ZERO	5 500			
A320-211	ICAO_A	3	9	Climb	MaxClimb	ZERO	7 500			
A320-211	ICAO_A	3	10	Climb	MaxClimb	ZERO	10 000			
A320-211	ICAO_A	4	1	Takeoff	MaxTakeoff	1+F				
A320-211	ICAO_A	4	2	Climb	MaxTakeoff	1+F	1 500			
A320-211	ICAO_A	4	3	Climb	MaxClimb	1+F	3 000			
A320-211	ICAO_A	4	4	Accelerate	MaxClimb	1+F		670,3	201,2	
A320-211	ICAO_A	4	5	Accelerate	MaxClimb	1		816,4	213,5	

ACFTID	Profile_ID	Stage Length	Step Number	Step Type	Thrust Rating	Flap_ID	End Point Altitude (ft)	Rate Of Climb (ft/min)	End Point CAS (kt)	Accelerate_Percent (%)
A320-211	ICAO_A	4	6	Accelerate	MaxClimb	ZERO		942	235,2	
A320-211	ICAO_A	4	7	Accelerate	MaxClimb	ZERO		1 017,5	250	
A320-211	ICAO_A	4	8	Climb	MaxClimb	ZERO	5 500			
A320-211	ICAO_A	4	9	Climb	MaxClimb	ZERO	7 500			
A320-211	ICAO_A	4	10	Climb	MaxClimb	ZERO	10 000			
A320-211	ICAO_A	5	1	Takeoff	MaxTakeoff	1+F				
A320-211	ICAO_A	5	2	Climb	MaxTakeoff	1+F	1 500			
A320-211	ICAO_A	5	3	Climb	MaxClimb	1+F	3 000			
A320-211	ICAO_A	5	4	Accelerate	MaxClimb	1+F		640,5	205	
A320-211	ICAO_A	5	5	Accelerate	MaxClimb	1		789,5	216,6	
A320-211	ICAO_A	5	6	Accelerate	MaxClimb	ZERO		899,5	237,1	
A320-211	ICAO_A	5	7	Accelerate	MaxClimb	ZERO		968,2	250	
A320-211	ICAO_A	5	8	Climb	MaxClimb	ZERO	5 500			
A320-211	ICAO_A	5	9	Climb	MaxClimb	ZERO	7 500			
A320-211	ICAO_A	5	10	Climb	MaxClimb	ZERO	10 000			
A320-211	ICAO_B	1	1	Takeoff	MaxTakeoff	1+F				
A320-211	ICAO_B	1	2	Climb	MaxTakeoff	1+F	1 000			
A320-211	ICAO_B	1	3	Accelerate	MaxTakeoff	1+F		1 150,5	186,2	
A320-211	ICAO_B	1	4	Accelerate	MaxTakeoff	1		1 300,7	208,1	
A320-211	ICAO_B	1	5	Climb	MaxClimb	ZERO	3 000			

ACFTID	Profile_ID	Stage Length	Step Number	Step Type	Thrust Rating	Flap_ID	End Point Altitude (ft)	Rate Of Climb (ft/min)	End Point CAS (kt)	Accelerate_Percent (%)
A320-211	ICAO_B	1	6	Accelerate	MaxClimb	ZERO		1 230,7	250	
A320-211	ICAO_B	1	7	Climb	MaxClimb	ZERO	5 500			
A320-211	ICAO_B	1	8	Climb	MaxClimb	ZERO	7 500			
A320-211	ICAO_B	1	9	Climb	MaxClimb	ZERO	10 000			
A320-211	ICAO_B	2	1	Takeoff	MaxTakeoff	1+F				
A320-211	ICAO_B	2	2	Climb	MaxTakeoff	1+F	1 000			
A320-211	ICAO_B	2	3	Accelerate	MaxTakeoff	1+F		1 098,5	190,2	
A320-211	ICAO_B	2	4	Accelerate	MaxTakeoff	1		1 243,7	210,7	
A320-211	ICAO_B	2	5	Climb	MaxClimb	ZERO	3 000			
A320-211	ICAO_B	2	6	Accelerate	MaxClimb	ZERO		1 171	250	
A320-211	ICAO_B	2	7	Climb	MaxClimb	ZERO	5 500			
A320-211	ICAO_B	2	8	Climb	MaxClimb	ZERO	7 500			
A320-211	ICAO_B	2	9	Climb	MaxClimb	ZERO	10 000			
A320-211	ICAO_B	3	1	Takeoff	MaxTakeoff	1+F				
A320-211	ICAO_B	3	2	Climb	MaxTakeoff	1+F	1 000			
A320-211	ICAO_B	3	3	Accelerate	MaxTakeoff	1+F		1 049,6	194,3	
A320-211	ICAO_B	3	4	Accelerate	MaxTakeoff	1		1 189,2	213,5	
A320-211	ICAO_B	3	5	Climb	MaxClimb	ZERO	3 000			
A320-211	ICAO_B	3	6	Accelerate	MaxClimb	ZERO		1 113,9	250	
A320-211	ICAO_B	3	7	Climb	MaxClimb	ZERO	5 500			

ACFTID	Profile_ID	Stage Length	Step Number	Step Type	Thrust Rating	Flap_ID	End Point Altitude (ft)	Rate Of Climb (ft/min)	End Point CAS (kt)	Accelerate_Percent (%)
A320-211	ICAO_B	3	8	Climb	MaxClimb	ZERO	7 500			
A320-211	ICAO_B	3	9	Climb	MaxClimb	ZERO	10 000			
A320-211	ICAO_B	4	1	Takeoff	MaxTakeoff	1+F				
A320-211	ICAO_B	4	2	Climb	MaxTakeoff	1+F	1 000			
A320-211	ICAO_B	4	3	Accelerate	MaxTakeoff	1+F		972,6	201,4	
A320-211	ICAO_B	4	4	Accelerate	MaxTakeoff	1		1 101	218,7	
A320-211	ICAO_B	4	5	Climb	MaxClimb	ZERO	3 000			
A320-211	ICAO_B	4	6	Accelerate	MaxClimb	ZERO		1 021	250	
A320-211	ICAO_B	4	7	Climb	MaxClimb	ZERO	5 500			
A320-211	ICAO_B	4	8	Climb	MaxClimb	ZERO	7 500			
A320-211	ICAO_B	4	9	Climb	MaxClimb	ZERO	10 000			
A320-211	ICAO_B	5	1	Takeoff	MaxTakeoff	1+F				
A320-211	ICAO_B	5	2	Climb	MaxTakeoff	1+F	1 000			
A320-211	ICAO_B	5	3	Accelerate	MaxTakeoff	1+F		933,1	205,1	
A320-211	ICAO_B	5	4	Accelerate	MaxTakeoff	1		1 056	221,4	
A320-211	ICAO_B	5	5	Climb	MaxClimb	ZERO	3 000			
A320-211	ICAO_B	5	6	Accelerate	MaxClimb	ZERO		973,2	250	
A320-211	ICAO_B	5	7	Climb	MaxClimb	ZERO	5 500			
A320-211	ICAO_B	5	8	Climb	MaxClimb	ZERO	7 500			
A320-211	ICAO_B	5	9	Climb	MaxClimb	ZERO	10 000			

ACFTID	Profile_ID	Stage Length	Step Number	Step Type	Thrust Rating	Flap_ID	End Point Altitude (ft)	Rate Of Climb (ft/min)	End Point CAS (kt)	Accelerate_Percent (%)
A 320-232	DEFAULT	1	1	Takeoff	MaxTakeoff	1+F				
A 320-232	DEFAULT	1	2	Climb	MaxTakeoff	1+F	1 000			
A 320-232	DEFAULT	1	3	Accelerate	MaxTakeoff	1+F		1 219,6	185,5	
A 320-232	DEFAULT	1	4	Accelerate	MaxTakeoff	1		1 372,6	208,6	
A 320-232	DEFAULT	1	5	Climb	MaxClimb	ZERO	3 000			
A 320-232	DEFAULT	1	6	Accelerate	MaxClimb	ZERO		1 192,1	250	
A 320-232	DEFAULT	1	7	Climb	MaxClimb	ZERO	5 500			
A 320-232	DEFAULT	1	8	Climb	MaxClimb	ZERO	7 500			
A 320-232	DEFAULT	1	9	Climb	MaxClimb	ZERO	10 000			
A 320-232	DEFAULT	2	1	Takeoff	MaxTakeoff	1+F				
A 320-232	DEFAULT	2	2	Climb	MaxTakeoff	1+F	1 000			
A 320-232	DEFAULT	2	3	Accelerate	MaxTakeoff	1+F		1 167,9	189,3	
A 320-232	DEFAULT	2	4	Accelerate	MaxTakeoff	1		1 315,7	211	
A 320-232	DEFAULT	2	5	Climb	MaxClimb	ZERO	3 000			
A 320-232	DEFAULT	2	6	Accelerate	MaxClimb	ZERO		1 137,4	250	
A 320-232	DEFAULT	2	7	Climb	MaxClimb	ZERO	5 500			
A 320-232	DEFAULT	2	8	Climb	MaxClimb	ZERO	7 500			
A 320-232	DEFAULT	2	9	Climb	MaxClimb	ZERO	10 000			
A 320-232	DEFAULT	3	1	Takeoff	MaxTakeoff	1+F				
A 320-232	DEFAULT	3	2	Climb	MaxTakeoff	1+F	1 000			

ACFTID	Profile_ID	Stage Length	Step Number	Step Type	Thrust Rating	Flap_ID	End Point Altitude (ft)	Rate Of Climb (ft/min)	End Point CAS (kt)	Accelerate_Percent (%)
A 320-232	DEFAULT	3	3	Accelerate	MaxTakeoff	1+F		1 118,6	193,2	
A 320-232	DEFAULT	3	4	Accelerate	MaxTakeoff	1		1 260,6	213,6	
A 320-232	DEFAULT	3	5	Climb	MaxClimb	ZERO	3 000			
A 320-232	DEFAULT	3	6	Accelerate	MaxClimb	ZERO		1 085,2	250	
A 320-232	DEFAULT	3	7	Climb	MaxClimb	ZERO	5 500			
A 320-232	DEFAULT	3	8	Climb	MaxClimb	ZERO	7 500			
A 320-232	DEFAULT	3	9	Climb	MaxClimb	ZERO	10 000			
A 320-232	DEFAULT	4	1	Takeoff	MaxTakeoff	1+F				
A 320-232	DEFAULT	4	2	Climb	MaxTakeoff	1+F	1 000			
A 320-232	DEFAULT	4	3	Accelerate	MaxTakeoff	1+F		1 040,6	199,9	
A 320-232	DEFAULT	4	4	Accelerate	MaxTakeoff	1		1 170,7	218,4	
A 320-232	DEFAULT	4	5	Climb	MaxClimb	ZERO	3 000			
A 320-232	DEFAULT	4	6	Accelerate	MaxClimb	ZERO		1 001,5	250	
A 320-232	DEFAULT	4	7	Climb	MaxClimb	ZERO	5 500			
A 320-232	DEFAULT	4	8	Climb	MaxClimb	ZERO	7 500			
A 320-232	DEFAULT	4	9	Climb	MaxClimb	ZERO	10 000			
A 320-232	DEFAULT	5	1	Takeoff	MaxTakeoff	1+F				
A 320-232	DEFAULT	5	2	Climb	MaxTakeoff	1+F	1 000			
A 320-232	DEFAULT	5	3	Accelerate	MaxTakeoff	1+F		921,9	210,9	
A 320-232	DEFAULT	5	4	Accelerate	MaxTakeoff	1		1 033,9	226,5	

ACFTID	Profile_ID	Stage Length	Step Number	Step Type	Thrust Rating	Flap_ID	End Point Altitude (ft)	Rate Of Climb (ft/min)	End Point CAS (kt)	Accelerate_Percent (%)
A320-232	DEFAULT	5	5	Climb	MaxClimb	ZERO	3 000			
A320-232	DEFAULT	5	6	Accelerate	MaxClimb	ZERO		876,3	250	
A320-232	DEFAULT	5	7	Climb	MaxClimb	ZERO	5 500			
A320-232	DEFAULT	5	8	Climb	MaxClimb	ZERO	7 500			
A320-232	DEFAULT	5	9	Climb	MaxClimb	ZERO	10 000			
A320-232	ICAO_A	1	1	Takeoff	MaxTakeoff	1+F				
A320-232	ICAO_A	1	2	Climb	MaxTakeoff	1+F	1 500			
A320-232	ICAO_A	1	3	Climb	MaxClimb	1+F	3 000			
A320-232	ICAO_A	1	4	Accelerate	MaxClimb	1+F		776,1	185,4	
A320-232	ICAO_A	1	5	Accelerate	MaxClimb	1		906,7	200,1	
A320-232	ICAO_A	1	6	Accelerate	MaxClimb	ZERO		1 062	226	
A320-232	ICAO_A	1	7	Accelerate	MaxClimb	ZERO		1 218,7	250	
A320-232	ICAO_A	1	8	Climb	MaxClimb	ZERO	5 500			
A320-232	ICAO_A	1	9	Climb	MaxClimb	ZERO	7 500			
A320-232	ICAO_A	1	10	Climb	MaxClimb	ZERO	10 000			
A320-232	ICAO_A	2	1	Takeoff	MaxTakeoff	1+F				
A320-232	ICAO_A	2	2	Climb	MaxTakeoff	1+F	1 500			
A320-232	ICAO_A	2	3	Climb	MaxClimb	1+F	3 000			
A320-232	ICAO_A	2	4	Accelerate	MaxClimb	1+F		739,7	189,1	
A320-232	ICAO_A	2	5	Accelerate	MaxClimb	1		870	203	

ACFTID	Profile_ID	Stage Length	Step Number	Step Type	Thrust Rating	Flap_ID	End Point Altitude (ft)	Rate Of Climb (ft/min)	End Point CAS (kt)	Accelerate_Percent (%)
A320-232	ICAO_A	2	6	Accelerate	MaxClimb	ZERO		1 015,7	227,5	
A320-232	ICAO_A	2	7	Accelerate	MaxClimb	ZERO		1 160,7	250	
A320-232	ICAO_A	2	8	Climb	MaxClimb	ZERO	5 500			
A320-232	ICAO_A	2	9	Climb	MaxClimb	ZERO	7 500			
A320-232	ICAO_A	2	10	Climb	MaxClimb	ZERO	10 000			
A320-232	ICAO_A	3	1	Takeoff	MaxTakeoff	1+F				
A320-232	ICAO_A	3	2	Climb	MaxTakeoff	1+F	1 500			
A320-232	ICAO_A	3	3	Climb	MaxClimb	1+F	3 000			
A320-232	ICAO_A	3	4	Accelerate	MaxClimb	1+F		705	193	
A320-232	ICAO_A	3	5	Accelerate	MaxClimb	1		834,6	206,1	
A320-232	ICAO_A	3	6	Accelerate	MaxClimb	ZERO		971,6	229,2	
A320-232	ICAO_A	3	7	Accelerate	MaxClimb	ZERO		1 105,4	250	
A320-232	ICAO_A	3	8	Climb	MaxClimb	ZERO	5 500			
A320-232	ICAO_A	3	9	Climb	MaxClimb	ZERO	7 500			
A320-232	ICAO_A	3	10	Climb	MaxClimb	ZERO	10 000			
A320-232	ICAO_A	4	1	Takeoff	MaxTakeoff	1+F				
A320-232	ICAO_A	4	2	Climb	MaxTakeoff	1+F	1 500			
A320-232	ICAO_A	4	3	Climb	MaxClimb	1+F	3 000			
A320-232	ICAO_A	4	4	Accelerate	MaxClimb	1+F		650,5	199,8	
A320-232	ICAO_A	4	5	Accelerate	MaxClimb	1		776,9	211,6	

ACFTID	Profile_ID	Stage Length	Step Number	Step Type	Thrust Rating	Flap_ID	End Point Altitude (ft)	Rate Of Climb (ft/min)	End Point CAS (kt)	Accelerate_Percent (%)
A320-232	ICAO_A	4	6	Accelerate	MaxClimb	ZERO		901,1	232,6	
A320-232	ICAO_A	4	7	Accelerate	MaxClimb	ZERO		1 016,8	250	
A320-232	ICAO_A	4	8	Climb	MaxClimb	ZERO	5 500			
A320-232	ICAO_A	4	9	Climb	MaxClimb	ZERO	7 500			
A320-232	ICAO_A	4	10	Climb	MaxClimb	ZERO	10 000			
A320-232	ICAO_A	5	1	Takeoff	MaxTakeoff	1+F				
A320-232	ICAO_A	5	2	Climb	MaxTakeoff	1+F	1 500			
A320-232	ICAO_A	5	3	Climb	MaxClimb	1+F	3 000			
A320-232	ICAO_A	5	4	Accelerate	MaxClimb	1+F		568,3	210,7	
A320-232	ICAO_A	5	5	Accelerate	MaxClimb	1		687,3	220,6	
A320-232	ICAO_A	5	6	Accelerate	MaxClimb	ZERO		794,5	238,5	
A320-232	ICAO_A	5	7	Accelerate	MaxClimb	ZERO		884,4	250	
A320-232	ICAO_A	5	8	Climb	MaxClimb	ZERO	5 500			
A320-232	ICAO_A	5	9	Climb	MaxClimb	ZERO	7 500			
A320-232	ICAO_A	5	10	Climb	MaxClimb	ZERO	10 000			
A320-232	ICAO_B	1	1	Takeoff	MaxTakeoff	1+F				
A320-232	ICAO_B	1	2	Climb	MaxTakeoff	1+F	1 000			
A320-232	ICAO_B	1	3	Accelerate	MaxTakeoff	1+F		1 219,6	185,5	
A320-232	ICAO_B	1	4	Accelerate	MaxTakeoff	1		1 372,6	208,6	
A320-232	ICAO_B	1	5	Climb	MaxClimb	ZERO	3 000			

ACFTID	Profile_ID	Stage Length	Step Number	Step Type	Thrust Rating	Flap_ID	End Point Altitude (ft)	Rate Of Climb (ft/min)	End Point CAS (kt)	Accelerate_Percent (%)
A320-232	ICAO_B	1	6	Accelerate	MaxClimb	ZERO		1 192,1	250	
A320-232	ICAO_B	1	7	Climb	MaxClimb	ZERO	5 500			
A320-232	ICAO_B	1	8	Climb	MaxClimb	ZERO	7 500			
A320-232	ICAO_B	1	9	Climb	MaxClimb	ZERO	10 000			
A320-232	ICAO_B	2	1	Takeoff	MaxTakeoff	1+F				
A320-232	ICAO_B	2	2	Climb	MaxTakeoff	1+F	1 000			
A320-232	ICAO_B	2	3	Accelerate	MaxTakeoff	1+F		1 167,9	189,3	
A320-232	ICAO_B	2	4	Accelerate	MaxTakeoff	1		1 315,7	211	
A320-232	ICAO_B	2	5	Climb	MaxClimb	ZERO	3 000			
A320-232	ICAO_B	2	6	Accelerate	MaxClimb	ZERO		1 137,4	250	
A320-232	ICAO_B	2	7	Climb	MaxClimb	ZERO	5 500			
A320-232	ICAO_B	2	8	Climb	MaxClimb	ZERO	7 500			
A320-232	ICAO_B	2	9	Climb	MaxClimb	ZERO	10 000			
A320-232	ICAO_B	3	1	Takeoff	MaxTakeoff	1+F				
A320-232	ICAO_B	3	2	Climb	MaxTakeoff	1+F	1 000			
A320-232	ICAO_B	3	3	Accelerate	MaxTakeoff	1+F		1 118,6	193,2	
A320-232	ICAO_B	3	4	Accelerate	MaxTakeoff	1		1 260,6	213,6	
A320-232	ICAO_B	3	5	Climb	MaxClimb	ZERO	3 000			
A320-232	ICAO_B	3	6	Accelerate	MaxClimb	ZERO		1 085,2	250	
A320-232	ICAO_B	3	7	Climb	MaxClimb	ZERO	5 500			

ACFTID	Profile_ID	Stage Length	Step Number	Step Type	Thrust Rating	Flap_ID	End Point Altitude (ft)	Rate Of Climb (ft/min)	End Point CAS (kt)	Accelerate_Percent (%)
A 320-232	ICAO_B	3	8	Climb	MaxClimb	ZERO	7 500			
A 320-232	ICAO_B	3	9	Climb	MaxClimb	ZERO	10 000			

Table I-4 (part 3)

Default departures procedural steps

ACFTID	Profile_ID	Stage Length	Step Number	Step Type	Thrust Rating	Flap_ID	End Point Altitude (ft)	Rate Of Climb (ft/min)	End Point CAS (kt)	Accelerate_Percent (%)
A 320-232	ICAO_B	4	1	Takeoff	MaxTakeoff	1+F				
A 320-232	ICAO_B	4	2	Climb	MaxTakeoff	1+F	1 000			
A 320-232	ICAO_B	4	3	Accelerate	MaxTakeoff	1+F		1 040,6	199,9	
A 320-232	ICAO_B	4	4	Accelerate	MaxTakeoff	1		1 170,7	218,4	
A 320-232	ICAO_B	4	5	Climb	MaxClimb	ZERO	3 000			
A 320-232	ICAO_B	4	6	Accelerate	MaxClimb	ZERO		1 001,5	250	
A 320-232	ICAO_B	4	7	Climb	MaxClimb	ZERO	5 500			
A 320-232	ICAO_B	4	8	Climb	MaxClimb	ZERO	7 500			
A 320-232	ICAO_B	4	9	Climb	MaxClimb	ZERO	10 000			
A 320-232	ICAO_B	5	1	Takeoff	MaxTakeoff	1+F				
A 320-232	ICAO_B	5	2	Climb	MaxTakeoff	1+F	1 000			
A 320-232	ICAO_B	5	3	Accelerate	MaxTakeoff	1+F		921,9	210,9	
A 320-232	ICAO_B	5	4	Accelerate	MaxTakeoff	1		1 033,9	226,5	
A 320-232	ICAO_B	5	5	Climb	MaxClimb	ZERO	3 000			
A 320-232	ICAO_B	5	6	Accelerate	MaxClimb	ZERO		876,3	250	

ACFTID	Profile_ID	Stage Length	Step Number	Step Type	Thrust Rating	Flap_ID	End Point Altitude (ft)	Rate Of Climb (ft/min)	End Point CAS (kt)	Accelerate_Percent (%)
A320-232	ICAO_B	5	7	Climb	MaxClimb	ZERO	5 500			
A320-232	ICAO_B	5	8	Climb	MaxClimb	ZERO	7 500			
A320-232	ICAO_B	5	9	Climb	MaxClimb	ZERO	10 000			
A321-232	DEFAULT	1	1	Takeoff	MaxTakeoff	1+F				
A321-232	DEFAULT	1	2	Climb	MaxTakeoff	1+F	1 000			
A321-232	DEFAULT	1	3	Accelerate	MaxTakeoff	1+F		1 235,6	195	
A321-232	DEFAULT	1	4	Accelerate	MaxTakeoff	1		1 376	219,7	
A321-232	DEFAULT	1	5	Climb	MaxClimb	ZERO	3 000			
A321-232	DEFAULT	1	6	Accelerate	MaxClimb	ZERO		1 127,8	250	
A321-232	DEFAULT	1	7	Climb	MaxClimb	ZERO	5 500			
A321-232	DEFAULT	1	8	Climb	MaxClimb	ZERO	7 500			
A321-232	DEFAULT	1	9	Climb	MaxClimb	ZERO	10 000			
A321-232	DEFAULT	2	1	Takeoff	MaxTakeoff	1+F				
A321-232	DEFAULT	2	2	Climb	MaxTakeoff	1+F	1 000			
A321-232	DEFAULT	2	3	Accelerate	MaxTakeoff	1+F		1 180,9	199	
A321-232	DEFAULT	2	4	Accelerate	MaxTakeoff	1		1 316,8	222,2	
A321-232	DEFAULT	2	5	Climb	MaxClimb	ZERO	3 000			
A321-232	DEFAULT	2	6	Accelerate	MaxClimb	ZERO		1 070,3	250	
A321-232	DEFAULT	2	7	Climb	MaxClimb	ZERO	5 500			
A321-232	DEFAULT	2	8	Climb	MaxClimb	ZERO	7 500			

ACFTID	Profile_ID	Stage Length	Step Number	Step Type	Thrust Rating	Flap_ID	End Point Altitude (ft)	Rate Of Climb (ft/min)	End Point CAS (kt)	Accelerate_Percent (%)
A 321-232	DEFAULT	2	9	Climb	MaxClimb	ZERO	10 000			
A 321-232	DEFAULT	3	1	Takeoff	MaxTakeoff	1+F				
A 321-232	DEFAULT	3	2	Climb	MaxTakeoff	1+F	1 000			
A 321-232	DEFAULT	3	3	Accelerate	MaxTakeoff	1+F		1 127,9	203	
A 321-232	DEFAULT	3	4	Accelerate	MaxTakeoff	1		1 259,2	224,8	
A 321-232	DEFAULT	3	5	Climb	MaxClimb	ZERO	3 000			
A 321-232	DEFAULT	3	6	Accelerate	MaxClimb	ZERO		1 015,1	250	
A 321-232	DEFAULT	3	7	Climb	MaxClimb	ZERO	5 500			
A 321-232	DEFAULT	3	8	Climb	MaxClimb	ZERO	7 500			
A 321-232	DEFAULT	3	9	Climb	MaxClimb	ZERO	10 000			
A 321-232	DEFAULT	4	1	Takeoff	MaxTakeoff	1+F				
A 321-232	DEFAULT	4	2	Climb	MaxTakeoff	1+F	1 000			
A 321-232	DEFAULT	4	3	Accelerate	MaxTakeoff	1+F		1 039	209	
A 321-232	DEFAULT	4	4	Accelerate	MaxTakeoff	1		1 161,6	228,6	
A 321-232	DEFAULT	4	5	Climb	MaxClimb	ZERO	3 000			
A 321-232	DEFAULT	4	6	Accelerate	MaxClimb	ZERO		923,7	250	
A 321-232	DEFAULT	4	7	Climb	MaxClimb	ZERO	5 500			
A 321-232	DEFAULT	4	8	Climb	MaxClimb	ZERO	7 500			
A 321-232	DEFAULT	4	9	Climb	MaxClimb	ZERO	10 000			
A 321-232	DEFAULT	5	1	Takeoff	MaxTakeoff	1+F				

ACFTID	Profile_ID	Stage Length	Step Number	Step Type	Thrust Rating	Flap_ID	End Point Altitude (ft)	Rate Of Climb (ft/min)	End Point CAS (kt)	Accelerate_Percent (%)
A321-232	DEFAULT	5	2	Climb	MaxTakeoff	1+F	1 000			
A321-232	DEFAULT	5	3	Accelerate	MaxTakeoff	1+F		889,6	210	
A321-232	DEFAULT	5	4	Accelerate	MaxTakeoff	1		969,1	226,5	
A321-232	DEFAULT	5	5	Climb	MaxClimb	ZERO	3 000			
A321-232	DEFAULT	5	6	Accelerate	MaxClimb	ZERO		752,3	250	
A321-232	DEFAULT	5	7	Climb	MaxClimb	ZERO	5 500			
A321-232	DEFAULT	5	8	Climb	MaxClimb	ZERO	7 500			
A321-232	DEFAULT	5	9	Climb	MaxClimb	ZERO	10 000			
A321-232	ICAO_A	1	1	Takeoff	MaxTakeoff	1+F				
A321-232	ICAO_A	1	2	Climb	MaxTakeoff	1+F	1 500			
A321-232	ICAO_A	1	3	Climb	MaxClimb	1+F	3 000			
A321-232	ICAO_A	1	4	Accelerate	MaxClimb	1+F		819,7	194,9	
A321-232	ICAO_A	1	5	Accelerate	MaxClimb	1		920,7	210,8	
A321-232	ICAO_A	1	6	Accelerate	MaxClimb	ZERO		1 039,9	234,6	
A321-232	ICAO_A	1	7	Accelerate	MaxClimb	ZERO		1 125,4	250	
A321-232	ICAO_A	1	8	Climb	MaxClimb	ZERO	5 500			
A321-232	ICAO_A	1	9	Climb	MaxClimb	ZERO	7 500			
A321-232	ICAO_A	1	10	Climb	MaxClimb	ZERO	10 000			
A321-232	ICAO_A	2	1	Takeoff	MaxTakeoff	1+F				
A321-232	ICAO_A	2	2	Climb	MaxTakeoff	1+F	1 500			

ACFTID	Profile_ID	Stage Length	Step Number	Step Type	Thrust Rating	Flap_ID	End Point Altitude (ft)	Rate Of Climb (ft/min)	End Point CAS (kt)	Accelerate_Percent (%)
A321-232	ICAO_A	2	3	Climb	MaxClimb	1+F	3 000			
A321-232	ICAO_A	2	4	Accelerate	MaxClimb	1+F		778,4	198,9	
A321-232	ICAO_A	2	5	Accelerate	MaxClimb	1		874,3	213,7	
A321-232	ICAO_A	2	6	Accelerate	MaxClimb	ZERO		987,1	236,1	
A321-232	ICAO_A	2	7	Accelerate	MaxClimb	ZERO		1 066,3	250	
A321-232	ICAO_A	2	8	Climb	MaxClimb	ZERO	5 500			
A321-232	ICAO_A	2	9	Climb	MaxClimb	ZERO	7 500			
A321-232	ICAO_A	2	10	Climb	MaxClimb	ZERO	10 000			
A321-232	ICAO_A	3	1	Takeoff	MaxTakeoff	1+F				
A321-232	ICAO_A	3	2	Climb	MaxTakeoff	1+F	1 500			
A321-232	ICAO_A	3	3	Climb	MaxClimb	1+F	3 000			
A321-232	ICAO_A	3	4	Accelerate	MaxClimb	1+F		737,9	202,9	
A321-232	ICAO_A	3	5	Accelerate	MaxClimb	1		829,1	216,7	
A321-232	ICAO_A	3	6	Accelerate	MaxClimb	ZERO		936,1	237,7	
A321-232	ICAO_A	3	7	Accelerate	MaxClimb	ZERO		1 009,5	250	
A321-232	ICAO_A	3	8	Climb	MaxClimb	ZERO	5 500			
A321-232	ICAO_A	3	9	Climb	MaxClimb	ZERO	7 500			
A321-232	ICAO_A	3	10	Climb	MaxClimb	ZERO	10 000			
A321-232	ICAO_A	4	1	Takeoff	MaxTakeoff	1+F				
A321-232	ICAO_A	4	2	Climb	MaxTakeoff	1+F	1 500			

ACFTID	Profile_ID	Stage Length	Step Number	Step Type	Thrust Rating	Flap_ID	End Point Altitude (ft)	Rate Of Climb (ft/min)	End Point CAS (kt)	Accelerate_Percent (%)
A321-232	ICAO_A	4	3	Climb	MaxClimb	1+F	3 000			
A321-232	ICAO_A	4	4	Accelerate	MaxClimb	1+F		670,5	209,9	
A321-232	ICAO_A	4	5	Accelerate	MaxClimb	1		754,2	222,1	
A321-232	ICAO_A	4	6	Accelerate	MaxClimb	ZERO		852,9	240,9	
A321-232	ICAO_A	4	7	Accelerate	MaxClimb	ZERO		917,2	250	
A321-232	ICAO_A	4	8	Climb	MaxClimb	ZERO	5 500			
A321-232	ICAO_A	4	9	Climb	MaxClimb	ZERO	7 500			
A321-232	ICAO_A	4	10	Climb	MaxClimb	ZERO	10 000			
A321-232	ICAO_A	5	1	Takeoff	MaxTakeoff	1+F				
A321-232	ICAO_A	5	2	Climb	MaxTakeoff	1+F	1 500			
A321-232	ICAO_A	5	3	Climb	MaxClimb	1+F	3 000			
A321-232	ICAO_A	5	4	Accelerate	MaxClimb	1+F		551,5	210	
A321-232	ICAO_A	5	5	Accelerate	MaxClimb	1		604,9	219,9	
A321-232	ICAO_A	5	6	Accelerate	MaxClimb	ZERO		685,2	235,3	
A321-232	ICAO_A	5	7	Accelerate	MaxClimb	ZERO		749,8	250	
A321-232	ICAO_A	5	8	Climb	MaxClimb	ZERO	5 500			
A321-232	ICAO_A	5	9	Climb	MaxClimb	ZERO	7 500			
A321-232	ICAO_A	5	10	Climb	MaxClimb	ZERO	10 000			
A321-232	ICAO_B	1	1	Takeoff	MaxTakeoff	1+F				
A321-232	ICAO_B	1	2	Climb	MaxTakeoff	1+F	1 000			

ACFTID	Profile_ID	Stage Length	Step Number	Step Type	Thrust Rating	Flap_ID	End Point Altitude (ft)	Rate Of Climb (ft/min)	End Point CAS (kt)	Accelerate_Percent (%)
A321-232	ICAO_B	1	3	Accelerate	MaxTakeoff	1+F		1 235,6	195	
A321-232	ICAO_B	1	4	Accelerate	MaxTakeoff	1		1 376	219,7	
A321-232	ICAO_B	1	5	Climb	MaxClimb	ZERO	3 000			
A321-232	ICAO_B	1	6	Accelerate	MaxClimb	ZERO		1 127,8	250	
A321-232	ICAO_B	1	7	Climb	MaxClimb	ZERO	5 500			
A321-232	ICAO_B	1	8	Climb	MaxClimb	ZERO	7 500			
A321-232	ICAO_B	1	9	Climb	MaxClimb	ZERO	10 000			
A321-232	ICAO_B	2	1	Takeoff	MaxTakeoff	1+F				
A321-232	ICAO_B	2	2	Climb	MaxTakeoff	1+F	1 000			
A321-232	ICAO_B	2	3	Accelerate	MaxTakeoff	1+F		1 180,9	199	
A321-232	ICAO_B	2	4	Accelerate	MaxTakeoff	1		1 316,8	222,2	
A321-232	ICAO_B	2	5	Climb	MaxClimb	ZERO	3 000			
A321-232	ICAO_B	2	6	Accelerate	MaxClimb	ZERO		1 070,3	250	
A321-232	ICAO_B	2	7	Climb	MaxClimb	ZERO	5 500			
A321-232	ICAO_B	2	8	Climb	MaxClimb	ZERO	7 500			
A321-232	ICAO_B	2	9	Climb	MaxClimb	ZERO	10 000			
A321-232	ICAO_B	3	1	Takeoff	MaxTakeoff	1+F				
A321-232	ICAO_B	3	2	Climb	MaxTakeoff	1+F	1 000			
A321-232	ICAO_B	3	3	Accelerate	MaxTakeoff	1+F		1 127,9	203	
A321-232	ICAO_B	3	4	Accelerate	MaxTakeoff	1		1 259,2	224,8	

ACFTID	Profile_ID	Stage Length	Step Number	Step Type	Thrust Rating	Flap_ID	End Point Altitude (ft)	Rate Of Climb (ft/min)	End Point CAS (kt)	Accelerate_Percent (%)
A321-232	ICAO_B	3	5	Climb	MaxClimb	ZERO	3 000			
A321-232	ICAO_B	3	6	Accelerate	MaxClimb	ZERO		1 015,1	250	
A321-232	ICAO_B	3	7	Climb	MaxClimb	ZERO	5 500			
A321-232	ICAO_B	3	8	Climb	MaxClimb	ZERO	7 500			
A321-232	ICAO_B	3	9	Climb	MaxClimb	ZERO	10 000			
A321-232	ICAO_B	4	1	Takeoff	MaxTakeoff	1+F				
A321-232	ICAO_B	4	2	Climb	MaxTakeoff	1+F	1 000			
A321-232	ICAO_B	4	3	Accelerate	MaxTakeoff	1+F		1 039	209	
A321-232	ICAO_B	4	4	Accelerate	MaxTakeoff	1		1 161,6	228,6	
A321-232	ICAO_B	4	5	Climb	MaxClimb	ZERO	3 000			
A321-232	ICAO_B	4	6	Accelerate	MaxClimb	ZERO		923,7	250	
A321-232	ICAO_B	4	7	Climb	MaxClimb	ZERO	5 500			
A321-232	ICAO_B	4	8	Climb	MaxClimb	ZERO	7 500			
A321-232	ICAO_B	4	9	Climb	MaxClimb	ZERO	10 000			
A321-232	ICAO_B	5	1	Takeoff	MaxTakeoff	1+F				
A321-232	ICAO_B	5	2	Climb	MaxTakeoff	1+F	1 000			
A321-232	ICAO_B	5	3	Accelerate	MaxTakeoff	1+F		889,6	210	
A321-232	ICAO_B	5	4	Accelerate	MaxTakeoff	1		969,1	226,5	
A321-232	ICAO_B	5	5	Climb	MaxClimb	ZERO	3 000			
A321-232	ICAO_B	5	6	Accelerate	MaxClimb	ZERO		752,3	250	

ACFTID	Profile_ID	Stage Length	Step Number	Step Type	Thrust Rating	Flap_ID	End Point Altitude (ft)	Rate Of Climb (ft/min)	End Point CAS (kt)	Accelerate_Percent (%)
A321-232	ICAO_B	5	7	Climb	MaxClimb	ZERO	5 500			
A321-232	ICAO_B	5	8	Climb	MaxClimb	ZERO	7 500			
A321-232	ICAO_B	5	9	Climb	MaxClimb	ZERO	10 000			
A330-301	DEFAULT	1	1	Takeoff	MaxTakeoff	1+F				
A330-301	DEFAULT	1	2	Climb	MaxTakeoff	1+F	1 000			
A330-301	DEFAULT	1	3	Accelerate	MaxTakeoff	1+F		1 160,6	170,7	
A330-301	DEFAULT	1	4	Accelerate	MaxTakeoff	1		1 267,7	207,4	
A330-301	DEFAULT	1	5	Climb	MaxClimb	ZERO	3 000			
A330-301	DEFAULT	1	6	Accelerate	MaxClimb	ZERO		1 218,2	250	
A330-301	DEFAULT	1	7	Climb	MaxClimb	ZERO	5 500			
A330-301	DEFAULT	1	8	Climb	MaxClimb	ZERO	7 500			
A330-301	DEFAULT	1	9	Climb	MaxClimb	ZERO	10 000			
A330-301	DEFAULT	2	1	Takeoff	MaxTakeoff	1+F				
A330-301	DEFAULT	2	2	Climb	MaxTakeoff	1+F	1 000			
A330-301	DEFAULT	2	3	Accelerate	MaxTakeoff	1+F		1 121,7	173,4	
A330-301	DEFAULT	2	4	Accelerate	MaxTakeoff	1		1 228,7	208,6	
A330-301	DEFAULT	2	5	Climb	MaxClimb	ZERO	3 000			
A330-301	DEFAULT	2	6	Accelerate	MaxClimb	ZERO		1 176	250	
A330-301	DEFAULT	2	7	Climb	MaxClimb	ZERO	5 500			
A330-301	DEFAULT	2	8	Climb	MaxClimb	ZERO	7 500			

ACFTID	Profile_ID	Stage Length	Step Number	Step Type	Thrust Rating	Flap_ID	End Point Altitude (ft)	Rate Of Climb (ft/min)	End Point CAS (kt)	Accelerate_Percent (%)
A330-301	DEFAULT	2	9	Climb	MaxClimb	ZERO	10 000			
A330-301	DEFAULT	3	1	Takeoff	MaxTakeoff	1+F				
A330-301	DEFAULT	3	2	Climb	MaxTakeoff	1+F	1 000			
A330-301	DEFAULT	3	3	Accelerate	MaxTakeoff	1+F		1 083,6	176,1	
A330-301	DEFAULT	3	4	Accelerate	MaxTakeoff	1		1 190,2	209,8	
A330-301	DEFAULT	3	5	Climb	MaxClimb	ZERO	3 000			
A330-301	DEFAULT	3	6	Accelerate	MaxClimb	ZERO		1 134,5	250	
A330-301	DEFAULT	3	7	Climb	MaxClimb	ZERO	5 500			
A330-301	DEFAULT	3	8	Climb	MaxClimb	ZERO	7 500			
A330-301	DEFAULT	3	9	Climb	MaxClimb	ZERO	10 000			
A330-301	DEFAULT	4	1	Takeoff	MaxTakeoff	1+F				
A330-301	DEFAULT	4	2	Climb	MaxTakeoff	1+F	1 000			
A330-301	DEFAULT	4	3	Accelerate	MaxTakeoff	1+F		1 022,6	180,8	
A330-301	DEFAULT	4	4	Accelerate	MaxTakeoff	1		1 126,6	212,1	
A330-301	DEFAULT	4	5	Climb	MaxClimb	ZERO	3 000			
A330-301	DEFAULT	4	6	Accelerate	MaxClimb	ZERO		1 066,4	250	
A330-301	DEFAULT	4	7	Climb	MaxClimb	ZERO	5 500			
A330-301	DEFAULT	4	8	Climb	MaxClimb	ZERO	7 500			
A330-301	DEFAULT	4	9	Climb	MaxClimb	ZERO	10 000			
A330-301	DEFAULT	5	1	Takeoff	MaxTakeoff	1+F				

ACFTID	Profile_ID	Stage Length	Step Number	Step Type	Thrust Rating	Flap_ID	End Point Altitude (ft)	Rate Of Climb (ft/min)	End Point CAS (kt)	Accelerate_Percent (%)
A330-301	DEFAULT	5	2	Climb	MaxTakeoff	1+F	1 000			
A330-301	DEFAULT	5	3	Accelerate	MaxTakeoff	1+F		951,6	186,7	
A330-301	DEFAULT	5	4	Accelerate	MaxTakeoff	1		1 051,7	215,3	
A330-301	DEFAULT	5	5	Climb	MaxClimb	ZERO	3 000			
A330-301	DEFAULT	5	6	Accelerate	MaxClimb	ZERO		986,6	250	
A330-301	DEFAULT	5	7	Climb	MaxClimb	ZERO	5 500			
A330-301	DEFAULT	5	8	Climb	MaxClimb	ZERO	7 500			
A330-301	DEFAULT	5	9	Climb	MaxClimb	ZERO	10 000			
A330-301	DEFAULT	6	1	Takeoff	MaxTakeoff	1+F				
A330-301	DEFAULT	6	2	Climb	MaxTakeoff	1+F	1 000			
A330-301	DEFAULT	6	3	Accelerate	MaxTakeoff	1+F		883,9	193	
A330-301	DEFAULT	6	4	Accelerate	MaxTakeoff	1		978,1	218,9	
A330-301	DEFAULT	6	5	Climb	MaxClimb	ZERO	3 000			
A330-301	DEFAULT	6	6	Accelerate	MaxClimb	ZERO		908,7	250	
A330-301	DEFAULT	6	7	Climb	MaxClimb	ZERO	5 500			
A330-301	DEFAULT	6	8	Climb	MaxClimb	ZERO	7 500			
A330-301	DEFAULT	6	9	Climb	MaxClimb	ZERO	10 000			
A330-301	DEFAULT	7	1	Takeoff	MaxTakeoff	1+F				
A330-301	DEFAULT	7	2	Climb	MaxTakeoff	1+F	1 000			
A330-301	DEFAULT	7	3	Accelerate	MaxTakeoff	1+F		864,2	195	

ACFTID	Profile_ID	Stage Length	Step Number	Step Type	Thrust Rating	Flap_ID	End Point Altitude (ft)	Rate Of Climb (ft/min)	End Point CAS (kt)	Accelerate_Percent (%)
A330-301	DEFAULT	7	4	Accelerate	MaxTakeoff	1		956,5	220,1	
A330-301	DEFAULT	7	5	Climb	MaxClimb	ZERO	3 000			
A330-301	DEFAULT	7	6	Accelerate	MaxClimb	ZERO		885,7	250	
A330-301	DEFAULT	7	7	Climb	MaxClimb	ZERO	5 500			
A330-301	DEFAULT	7	8	Climb	MaxClimb	ZERO	7 500			
A330-301	DEFAULT	7	9	Climb	MaxClimb	ZERO	10 000			
A330-301	ICAO_A	1	1	Takeoff	MaxTakeoff	1+F				
A330-301	ICAO_A	1	2	Climb	MaxTakeoff	1+F	1 500			
A330-301	ICAO_A	1	3	Climb	MaxClimb	1+F	3 000			
A330-301	ICAO_A	1	4	Accelerate	MaxClimb	1+F		722,8	170,7	
A330-301	ICAO_A	1	5	Accelerate	MaxClimb	1		783,9	193	
A330-301	ICAO_A	1	6	Accelerate	MaxClimb	ZERO		965	210,2	
A330-301	ICAO_A	1	7	Accelerate	MaxClimb	ZERO		1 210,9	250	
A330-301	ICAO_A	1	8	Climb	MaxClimb	ZERO	5 500			
A330-301	ICAO_A	1	9	Climb	MaxClimb	ZERO	7 500			
A330-301	ICAO_A	1	10	Climb	MaxClimb	ZERO	10 000			
A330-301	ICAO_A	2	1	Takeoff	MaxTakeoff	1+F				
A330-301	ICAO_A	2	2	Climb	MaxTakeoff	1+F	1 500			
A330-301	ICAO_A	2	3	Climb	MaxClimb	1+F	3 000			
A330-301	ICAO_A	2	4	Accelerate	MaxClimb	1+F		694,4	173,3	

ACFTID	Profile_ID	Stage Length	Step Number	Step Type	Thrust Rating	Flap_ID	End Point Altitude (ft)	Rate Of Climb (ft/min)	End Point CAS (kt)	Accelerate_Percent (%)
A330-301	ICAO_A	2	5	Accelerate	MaxClimb	1		758,4	194,7	
A330-301	ICAO_A	2	6	Accelerate	MaxClimb	ZERO		938	211,3	
A330-301	ICAO_A	2	7	Accelerate	MaxClimb	ZERO		1 168,1	250	
A330-301	ICAO_A	2	8	Climb	MaxClimb	ZERO	5 500			
A330-301	ICAO_A	2	9	Climb	MaxClimb	ZERO	7 500			
A330-301	ICAO_A	2	10	Climb	MaxClimb	ZERO	10 000			
A330-301	ICAO_A	3	1	Takeoff	MaxTakeoff	1+F				
A330-301	ICAO_A	3	2	Climb	MaxTakeoff	1+F	1 500			
A330-301	ICAO_A	3	3	Climb	MaxClimb	1+F	3 000			
A330-301	ICAO_A	3	4	Accelerate	MaxClimb	1+F		668,3	176	
A330-301	ICAO_A	3	5	Accelerate	MaxClimb	1		734,4	196,4	
A330-301	ICAO_A	3	6	Accelerate	MaxClimb	ZERO		911,9	212,4	
A330-301	ICAO_A	3	7	Accelerate	MaxClimb	ZERO		1 126,3	250	
A330-301	ICAO_A	3	8	Climb	MaxClimb	ZERO	5 500			
A330-301	ICAO_A	3	9	Climb	MaxClimb	ZERO	7 500			
A330-301	ICAO_A	3	10	Climb	MaxClimb	ZERO	10 000			
A330-301	ICAO_A	4	1	Takeoff	MaxTakeoff	1+F				
A330-301	ICAO_A	4	2	Climb	MaxTakeoff	1+F	1 500			
A330-301	ICAO_A	4	3	Climb	MaxClimb	1+F	3 000			
A330-301	ICAO_A	4	4	Accelerate	MaxClimb	1+F		622	180,8	

ACFTID	Profile_ID	Stage Length	Step Number	Step Type	Thrust Rating	Flap_ID	End Point Altitude (ft)	Rate Of Climb (ft/min)	End Point CAS (kt)	Accelerate_Percent (%)
A330-301	ICAO_A	4	5	Accelerate	MaxClimb	1		698,3	199,8	
A330-301	ICAO_A	4	6	Accelerate	MaxClimb	ZERO		871,8	214,9	
A330-301	ICAO_A	4	7	Accelerate	MaxClimb	ZERO		1 057,8	250	
A330-301	ICAO_A	4	8	Climb	MaxClimb	ZERO	5 500			
A330-301	ICAO_A	4	9	Climb	MaxClimb	ZERO	7 500			
A330-301	ICAO_A	4	10	Climb	MaxClimb	ZERO	10 000			
A330-301	ICAO_A	5	1	Takeoff	MaxTakeoff	1+F				
A330-301	ICAO_A	5	2	Climb	MaxTakeoff	1+F	1 500			
A330-301	ICAO_A	5	3	Climb	MaxClimb	1+F	3 000			
A330-301	ICAO_A	5	4	Accelerate	MaxClimb	1+F		569,3	186,8	
A330-301	ICAO_A	5	5	Accelerate	MaxClimb	1		663,1	204,4	
A330-301	ICAO_A	5	6	Accelerate	MaxClimb	ZERO		827,1	218,4	
A330-301	ICAO_A	5	7	Accelerate	MaxClimb	ZERO		977,1	250	
A330-301	ICAO_A	5	8	Climb	MaxClimb	ZERO	5 500			
A330-301	ICAO_A	5	9	Climb	MaxClimb	ZERO	7 500			
A330-301	ICAO_A	5	10	Climb	MaxClimb	ZERO	10 000			
A330-301	ICAO_A	6	1	Takeoff	MaxTakeoff	1+F				
A330-301	ICAO_A	6	2	Climb	MaxTakeoff	1+F	1 500			
A330-301	ICAO_A	6	3	Climb	MaxClimb	1+F	3 000			
A330-301	ICAO_A	6	4	Accelerate	MaxClimb	1+F		519,8	193	

ACFTID	Profile_ID	Stage Length	Step Number	Step Type	Thrust Rating	Flap_ID	End Point Altitude (ft)	Rate Of Climb (ft/min)	End Point CAS (kt)	Accelerate_Percent (%)
A330-301	ICAO_A	6	5	Accelerate	MaxClimb	1		634,2	209,3	
A330-301	ICAO_A	6	6	Accelerate	MaxClimb	ZERO		781	222,2	
A330-301	ICAO_A	6	7	Accelerate	MaxClimb	ZERO		898,1	250	
A330-301	ICAO_A	6	8	Climb	MaxClimb	ZERO	5 500			
A330-301	ICAO_A	6	9	Climb	MaxClimb	ZERO	7 500			
A330-301	ICAO_A	6	10	Climb	MaxClimb	ZERO	10 000			
A330-301	ICAO_A	7	1	Takeoff	MaxTakeoff	1+F				
A330-301	ICAO_A	7	2	Climb	MaxTakeoff	1+F	1 500			
A330-301	ICAO_A	7	3	Climb	MaxClimb	1+F	3 000			
A330-301	ICAO_A	7	4	Accelerate	MaxClimb	1+F		506,2	194,9	
A330-301	ICAO_A	7	5	Accelerate	MaxClimb	1		625,8	210,8	
A330-301	ICAO_A	7	6	Accelerate	MaxClimb	ZERO		766,4	223,5	
A330-301	ICAO_A	7	7	Accelerate	MaxClimb	ZERO		875,2	250	
A330-301	ICAO_A	7	8	Climb	MaxClimb	ZERO	5 500			
A330-301	ICAO_A	7	9	Climb	MaxClimb	ZERO	7 500			
A330-301	ICAO_A	7	10	Climb	MaxClimb	ZERO	10 000			
A330-301	ICAO_B	1	1	Takeoff	MaxTakeoff	1+F				
A330-301	ICAO_B	1	2	Climb	MaxTakeoff	1+F	1 000			
A330-301	ICAO_B	1	3	Accelerate	MaxTakeoff	1+F		1 160,6	170,7	
A330-301	ICAO_B	1	4	Accelerate	MaxTakeoff	1		1 267,7	207,4	

ACFTID	Profile_ID	Stage Length	Step Number	Step Type	Thrust Rating	Flap_ID	End Point Altitude (ft)	Rate Of Climb (ft/min)	End Point CAS (kt)	Accelerate_Percent (%)
A330-301	ICAO_B	1	5	Climb	MaxClimb	ZERO	3 000			
A330-301	ICAO_B	1	6	Accelerate	MaxClimb	ZERO		1 218,2	250	
A330-301	ICAO_B	1	7	Climb	MaxClimb	ZERO	5 500			
A330-301	ICAO_B	1	8	Climb	MaxClimb	ZERO	7 500			
A330-301	ICAO_B	1	9	Climb	MaxClimb	ZERO	10 000			
A330-301	ICAO_B	2	1	Takeoff	MaxTakeoff	1+F				
A330-301	ICAO_B	2	2	Climb	MaxTakeoff	1+F	1 000			
A330-301	ICAO_B	2	3	Accelerate	MaxTakeoff	1+F		1 121,7	173,4	
A330-301	ICAO_B	2	4	Accelerate	MaxTakeoff	1		1 228,7	208,6	
A330-301	ICAO_B	2	5	Climb	MaxClimb	ZERO	3 000			
A330-301	ICAO_B	2	6	Accelerate	MaxClimb	ZERO		1 176	250	
A330-301	ICAO_B	2	7	Climb	MaxClimb	ZERO	5 500			
A330-301	ICAO_B	2	8	Climb	MaxClimb	ZERO	7 500			
A330-301	ICAO_B	2	9	Climb	MaxClimb	ZERO	10 000			
A330-301	ICAO_B	3	1	Takeoff	MaxTakeoff	1+F				
A330-301	ICAO_B	3	2	Climb	MaxTakeoff	1+F	1 000			
A330-301	ICAO_B	3	3	Accelerate	MaxTakeoff	1+F		1 083,6	176,1	
A330-301	ICAO_B	3	4	Accelerate	MaxTakeoff	1		1 190,2	209,8	
A330-301	ICAO_B	3	5	Climb	MaxClimb	ZERO	3 000			
A330-301	ICAO_B	3	6	Accelerate	MaxClimb	ZERO		1 134,5	250	

ACFTID	Profile_ID	Stage Length	Step Number	Step Type	Thrust Rating	Flap_ID	End Point Altitude (ft)	Rate Of Climb (ft/min)	End Point CAS (kt)	Accelerate_Percent (%)
A330-301	ICAO_B	3	7	Climb	MaxClimb	ZERO	5 500			
A330-301	ICAO_B	3	8	Climb	MaxClimb	ZERO	7 500			
A330-301	ICAO_B	3	9	Climb	MaxClimb	ZERO	10 000			
A330-301	ICAO_B	4	1	Takeoff	MaxTakeoff	1+F				
A330-301	ICAO_B	4	2	Climb	MaxTakeoff	1+F	1 000			
A330-301	ICAO_B	4	3	Accelerate	MaxTakeoff	1+F		1 022,6	180,8	
A330-301	ICAO_B	4	4	Accelerate	MaxTakeoff	1		1 126,6	212,1	
A330-301	ICAO_B	4	5	Climb	MaxClimb	ZERO	3 000			
A330-301	ICAO_B	4	6	Accelerate	MaxClimb	ZERO		1 066,4	250	
A330-301	ICAO_B	4	7	Climb	MaxClimb	ZERO	5 500			
A330-301	ICAO_B	4	8	Climb	MaxClimb	ZERO	7 500			
A330-301	ICAO_B	4	9	Climb	MaxClimb	ZERO	10 000			
A330-301	ICAO_B	5	1	Takeoff	MaxTakeoff	1+F				
A330-301	ICAO_B	5	2	Climb	MaxTakeoff	1+F	1 000			
A330-301	ICAO_B	5	3	Accelerate	MaxTakeoff	1+F		951,6	186,7	
A330-301	ICAO_B	5	4	Accelerate	MaxTakeoff	1		1 051,7	215,3	
A330-301	ICAO_B	5	5	Climb	MaxClimb	ZERO	3 000			
A330-301	ICAO_B	5	6	Accelerate	MaxClimb	ZERO		986,6	250	
A330-301	ICAO_B	5	7	Climb	MaxClimb	ZERO	5 500			
A330-301	ICAO_B	5	8	Climb	MaxClimb	ZERO	7 500			

ACFTID	Profile_ID	Stage Length	Step Number	Step Type	Thrust Rating	Flap_ID	End Point Altitude (ft)	Rate Of Climb (ft/min)	End Point CAS (kt)	Accelerate_Percent (%)
A330-301	ICAO_B	5	9	Climb	MaxClimb	ZERO	10 000			
A330-301	ICAO_B	6	1	Takeoff	MaxTakeoff	1+F				
A330-301	ICAO_B	6	2	Climb	MaxTakeoff	1+F	1 000			
A330-301	ICAO_B	6	3	Accelerate	MaxTakeoff	1+F		883,9	193	
A330-301	ICAO_B	6	4	Accelerate	MaxTakeoff	1		978,1	218,9	
A330-301	ICAO_B	6	5	Climb	MaxClimb	ZERO	3 000			
A330-301	ICAO_B	6	6	Accelerate	MaxClimb	ZERO		908,7	250	
A330-301	ICAO_B	6	7	Climb	MaxClimb	ZERO	5 500			
A330-301	ICAO_B	6	8	Climb	MaxClimb	ZERO	7 500			
A330-301	ICAO_B	6	9	Climb	MaxClimb	ZERO	10 000			
A330-301	ICAO_B	7	1	Takeoff	MaxTakeoff	1+F				
A330-301	ICAO_B	7	2	Climb	MaxTakeoff	1+F	1 000			
A330-301	ICAO_B	7	3	Accelerate	MaxTakeoff	1+F		864,2	195	
A330-301	ICAO_B	7	4	Accelerate	MaxTakeoff	1		956,5	220,1	
A330-301	ICAO_B	7	5	Climb	MaxClimb	ZERO	3 000			
A330-301	ICAO_B	7	6	Accelerate	MaxClimb	ZERO		885,7	250	
A330-301	ICAO_B	7	7	Climb	MaxClimb	ZERO	5 500			
A330-301	ICAO_B	7	8	Climb	MaxClimb	ZERO	7 500			
A330-301	ICAO_B	7	9	Climb	MaxClimb	ZERO	10 000			
A330-343	DEFAULT	1	1	Takeoff	MaxTakeoff	1+F				

ACFTID	Profile_ID	Stage Length	Step Number	Step Type	Thrust Rating	Flap_ID	End Point Altitude (ft)	Rate Of Climb (ft/min)	End Point CAS (kt)	Accelerate_Percent (%)
A330-343	DEFAULT	1	2	Climb	MaxTakeoff	1+F	1 000			
A330-343	DEFAULT	1	3	Accelerate	MaxTakeoff	1+F		1 273,5	174,9	
A330-343	DEFAULT	1	4	Accelerate	MaxTakeoff	1		1 384,8	213,9	
A330-343	DEFAULT	1	5	Climb	MaxClimb	ZERO	3 000			
A330-343	DEFAULT	1	6	Accelerate	MaxClimb	ZERO		1 268,1	250	
A330-343	DEFAULT	1	7	Climb	MaxClimb	ZERO	5 500			
A330-343	DEFAULT	1	8	Climb	MaxClimb	ZERO	7 500			
A330-343	DEFAULT	1	9	Climb	MaxClimb	ZERO	10 000			
A330-343	DEFAULT	2	1	Takeoff	MaxTakeoff	1+F				
A330-343	DEFAULT	2	2	Climb	MaxTakeoff	1+F	1 000			
A330-343	DEFAULT	2	3	Accelerate	MaxTakeoff	1+F		1 218,9	177,7	
A330-343	DEFAULT	2	4	Accelerate	MaxTakeoff	1		1 340,4	215	
A330-343	DEFAULT	2	5	Climb	MaxClimb	ZERO	3 000			
A330-343	DEFAULT	2	6	Accelerate	MaxClimb	ZERO		1 223,6	250	
A330-343	DEFAULT	2	7	Climb	MaxClimb	ZERO	5 500			
A330-343	DEFAULT	2	8	Climb	MaxClimb	ZERO	7 500			
A330-343	DEFAULT	2	9	Climb	MaxClimb	ZERO	10 000			
A330-343	DEFAULT	3	1	Takeoff	MaxTakeoff	1+F				
A330-343	DEFAULT	3	2	Climb	MaxTakeoff	1+F	1 000			
A330-343	DEFAULT	3	3	Accelerate	MaxTakeoff	1+F		1 181,2	180,4	

ACFTID	Profile_ID	Stage Length	Step Number	Step Type	Thrust Rating	Flap_ID	End Point Altitude (ft)	Rate Of Climb (ft/min)	End Point CAS (kt)	Accelerate_Percent (%)
A330-343	DEFAULT	3	4	Accelerate	MaxTakeoff	1		1 296,6	216,1	
A330-343	DEFAULT	3	5	Climb	MaxClimb	ZERO	3 000			
A330-343	DEFAULT	3	6	Accelerate	MaxClimb	ZERO		1 180	250	
A330-343	DEFAULT	3	7	Climb	MaxClimb	ZERO	5 500			
A330-343	DEFAULT	3	8	Climb	MaxClimb	ZERO	7 500			
A330-343	DEFAULT	3	9	Climb	MaxClimb	ZERO	10 000			
A330-343	DEFAULT	4	1	Takeoff	MaxTakeoff	1+F				
A330-343	DEFAULT	4	2	Climb	MaxTakeoff	1+F	1 000			
A330-343	DEFAULT	4	3	Accelerate	MaxTakeoff	1+F		1 115,2	185,2	
A330-343	DEFAULT	4	4	Accelerate	MaxTakeoff	1		1 224,1	218,3	
A330-343	DEFAULT	4	5	Climb	MaxClimb	ZERO	3 000			
A330-343	DEFAULT	4	6	Accelerate	MaxClimb	ZERO		1 108,4	250	
A330-343	DEFAULT	4	7	Climb	MaxClimb	ZERO	5 500			
A330-343	DEFAULT	4	8	Climb	MaxClimb	ZERO	7 500			
A330-343	DEFAULT	4	9	Climb	MaxClimb	ZERO	10 000			
A330-343	DEFAULT	5	1	Takeoff	MaxTakeoff	1+F				
A330-343	DEFAULT	5	2	Climb	MaxTakeoff	1+F	1 000			
A330-343	DEFAULT	5	3	Accelerate	MaxTakeoff	1+F		1 038,3	191,3	
A330-343	DEFAULT	5	4	Accelerate	MaxTakeoff	1		1 139,2	221,4	
A330-343	DEFAULT	5	5	Climb	MaxClimb	ZERO	3 000			

ACFTID	Profile_ID	Stage Length	Step Number	Step Type	Thrust Rating	Flap_ID	End Point Altitude (ft)	Rate Of Climb (ft/min)	End Point CAS (kt)	Accelerate_Percent (%)
A330-343	DEFAULT	5	6	Accelerate	MaxClimb	ZERO		1 025,2	250	
A330-343	DEFAULT	5	7	Climb	MaxClimb	ZERO	5 500			
A330-343	DEFAULT	5	8	Climb	MaxClimb	ZERO	7 500			
A330-343	DEFAULT	5	9	Climb	MaxClimb	ZERO	10 000			
A330-343	DEFAULT	6	1	Takeoff	MaxTakeoff	1+F				
A330-343	DEFAULT	6	2	Climb	MaxTakeoff	1+F	1 000			
A330-343	DEFAULT	6	3	Accelerate	MaxTakeoff	1+F		962,8	197,3	
A330-343	DEFAULT	6	4	Accelerate	MaxTakeoff	1		1 054,3	224,5	
A330-343	DEFAULT	6	5	Climb	MaxClimb	ZERO	3 000			
A330-343	DEFAULT	6	6	Accelerate	MaxClimb	ZERO		943,3	250	
A330-343	DEFAULT	6	7	Climb	MaxClimb	ZERO	5 500			
A330-343	DEFAULT	6	8	Climb	MaxClimb	ZERO	7 500			
A330-343	DEFAULT	6	9	Climb	MaxClimb	ZERO	10 000			
A330-343	DEFAULT	7	1	Takeoff	MaxTakeoff	1+F				
A330-343	DEFAULT	7	2	Climb	MaxTakeoff	1+F	1 000			
A330-343	DEFAULT	7	3	Accelerate	MaxTakeoff	1+F		869,5	200,8	
A330-343	DEFAULT	7	4	Accelerate	MaxTakeoff	1		948,6	225	
A330-343	DEFAULT	7	5	Climb	MaxClimb	ZERO	3 000			
A330-343	DEFAULT	7	6	Accelerate	MaxClimb	ZERO		842	250	
A330-343	DEFAULT	7	7	Climb	MaxClimb	ZERO	5 500			

ACFTID	Profile_ID	Stage Length	Step Number	Step Type	Thrust Rating	Flap_ID	End Point Altitude (ft)	Rate Of Climb (ft/min)	End Point CAS (kt)	Accelerate_Percent (%)
A330-343	DEFAULT	7	8	Climb	MaxClimb	ZERO	7 500			
A330-343	DEFAULT	7	9	Climb	MaxClimb	ZERO	10 000			
A330-343	ICAO_A	1	1	Takeoff	MaxTakeoff	1+F				
A330-343	ICAO_A	1	2	Climb	MaxTakeoff	1+F	1 500			
A330-343	ICAO_A	1	3	Climb	MaxClimb	1+F	3 000			
A330-343	ICAO_A	1	4	Accelerate	MaxClimb	1+F		839,6	174,8	
A330-343	ICAO_A	1	5	Accelerate	MaxClimb	1		914,2	200,1	
A330-343	ICAO_A	1	6	Accelerate	MaxClimb	ZERO		1 103,7	218,9	
A330-343	ICAO_A	1	7	Accelerate	MaxClimb	ZERO		1 253,2	250	
A330-343	ICAO_A	1	8	Climb	MaxClimb	ZERO	5 500			
A330-343	ICAO_A	1	9	Climb	MaxClimb	ZERO	7 500			
A330-343	ICAO_A	1	10	Climb	MaxClimb	ZERO	10 000			
A330-343	ICAO_A	2	1	Takeoff	MaxTakeoff	1+F				
A330-343	ICAO_A	2	2	Climb	MaxTakeoff	1+F	1 500			
A330-343	ICAO_A	2	3	Climb	MaxClimb	1+F	3 000			
A330-343	ICAO_A	2	4	Accelerate	MaxClimb	1+F		801,5	177,5	
A330-343	ICAO_A	2	5	Accelerate	MaxClimb	1		885,4	201,7	
A330-343	ICAO_A	2	6	Accelerate	MaxClimb	ZERO		1 068,3	219,8	
A330-343	ICAO_A	2	7	Accelerate	MaxClimb	ZERO		1 208,4	250	
A330-343	ICAO_A	2	8	Climb	MaxClimb	ZERO	5 500			

ACFTID	Profile_ID	Stage Length	Step Number	Step Type	Thrust Rating	Flap_ID	End Point Altitude (ft)	Rate Of Climb (ft/min)	End Point CAS (kt)	Accelerate_Percent (%)
A330-343	ICAO_A	2	9	Climb	MaxClimb	ZERO	7 500			
A330-343	ICAO_A	2	10	Climb	MaxClimb	ZERO	10 000			
A330-343	ICAO_A	3	1	Takeoff	MaxTakeoff	1+F				
A330-343	ICAO_A	3	2	Climb	MaxTakeoff	1+F	1 500			
A330-343	ICAO_A	3	3	Climb	MaxClimb	1+F	3 000			
A330-343	ICAO_A	3	4	Accelerate	MaxClimb	1+F		766,4	180,3	
A330-343	ICAO_A	3	5	Accelerate	MaxClimb	1		857,9	203,5	
A330-343	ICAO_A	3	6	Accelerate	MaxClimb	ZERO		1 033,8	220,9	
A330-343	ICAO_A	3	7	Accelerate	MaxClimb	ZERO		1 164,8	250	
A330-343	ICAO_A	3	8	Climb	MaxClimb	ZERO	5 500			
A330-343	ICAO_A	3	9	Climb	MaxClimb	ZERO	7 500			
A330-343	ICAO_A	3	10	Climb	MaxClimb	ZERO	10 000			
A330-343	ICAO_A	4	1	Takeoff	MaxTakeoff	1+F				
A330-343	ICAO_A	4	2	Climb	MaxTakeoff	1+F	1 500			
A330-343	ICAO_A	4	3	Climb	MaxClimb	1+F	3 000			
A330-343	ICAO_A	4	4	Accelerate	MaxClimb	1+F		717,5	185,3	
A330-343	ICAO_A	4	5	Accelerate	MaxClimb	1		814,6	206,8	
A330-343	ICAO_A	4	6	Accelerate	MaxClimb	ZERO		977,3	223	
A330-343	ICAO_A	4	7	Accelerate	MaxClimb	ZERO		1 093,5	250	
A330-343	ICAO_A	4	8	Climb	MaxClimb	ZERO	5 500			

ACFTID	Profile_ID	Stage Length	Step Number	Step Type	Thrust Rating	Flap_ID	End Point Altitude (ft)	Rate Of Climb (ft/min)	End Point CAS (kt)	Accelerate_Percent (%)
A330-343	ICAO_A	4	9	Climb	MaxClimb	ZERO	7 500			
A330-343	ICAO_A	4	10	Climb	MaxClimb	ZERO	10 000			
A330-343	ICAO_A	5	1	Takeoff	MaxTakeoff	1+F				
A330-343	ICAO_A	5	2	Climb	MaxTakeoff	1+F	1 500			
A330-343	ICAO_A	5	3	Climb	MaxClimb	1+F	3 000			
A330-343	ICAO_A	5	4	Accelerate	MaxClimb	1+F		661,1	191,5	
A330-343	ICAO_A	5	5	Accelerate	MaxClimb	1		767	211,2	
A330-343	ICAO_A	5	6	Accelerate	MaxClimb	ZERO		910,6	226,1	
A330-343	ICAO_A	5	7	Accelerate	MaxClimb	ZERO		1 011	250	
A330-343	ICAO_A	5	8	Climb	MaxClimb	ZERO	5 500			
A330-343	ICAO_A	5	9	Climb	MaxClimb	ZERO	7 500			
A330-343	ICAO_A	5	10	Climb	MaxClimb	ZERO	10 000			
A330-343	ICAO_A	6	1	Takeoff	MaxTakeoff	1+F				
A330-343	ICAO_A	6	2	Climb	MaxTakeoff	1+F	1 500			
A330-343	ICAO_A	6	3	Climb	MaxClimb	1+F	3 000			
A330-343	ICAO_A	6	4	Accelerate	MaxClimb	1+F		607,1	197,4	
A330-343	ICAO_A	6	5	Accelerate	MaxClimb	1		717	215,3	
A330-343	ICAO_A	6	6	Accelerate	MaxClimb	ZERO		840,3	228,8	
A330-343	ICAO_A	6	7	Accelerate	MaxClimb	ZERO		929,9	250	
A330-343	ICAO_A	6	8	Climb	MaxClimb	ZERO	5 500			

ACFTID	Profile_ID	Stage Length	Step Number	Step Type	Thrust Rating	Flap_ID	End Point Altitude (ft)	Rate Of Climb (ft/min)	End Point CAS (kt)	Accelerate_Percent (%)
A330-343	ICAO_A	6	9	Climb	MaxClimb	ZERO	7 500			
A330-343	ICAO_A	6	10	Climb	MaxClimb	ZERO	10 000			
A330-343	ICAO_A	7	1	Takeoff	MaxTakeoff	1+F				
A330-343	ICAO_A	7	2	Climb	MaxTakeoff	1+F	1 500			
A330-343	ICAO_A	7	3	Climb	MaxClimb	1+F	3 000			
A330-343	ICAO_A	7	4	Accelerate	MaxClimb	1+F		538	200,4	
A330-343	ICAO_A	7	5	Accelerate	MaxClimb	1		638,8	216,2	
A330-343	ICAO_A	7	6	Accelerate	MaxClimb	ZERO		743,9	228,1	
A330-343	ICAO_A	7	7	Accelerate	MaxClimb	ZERO		830,4	250	
A330-343	ICAO_A	7	8	Climb	MaxClimb	ZERO	5 500			
A330-343	ICAO_A	7	9	Climb	MaxClimb	ZERO	7 500			
A330-343	ICAO_A	7	10	Climb	MaxClimb	ZERO	10 000			
A330-343	ICAO_B	1	1	Takeoff	MaxTakeoff	1+F				
A330-343	ICAO_B	1	2	Climb	MaxTakeoff	1+F	1 000			
A330-343	ICAO_B	1	3	Accelerate	MaxTakeoff	1+F		1 273,5	174,9	
A330-343	ICAO_B	1	4	Accelerate	MaxTakeoff	1		1 384,8	213,9	
A330-343	ICAO_B	1	5	Climb	MaxClimb	ZERO	3 000			
A330-343	ICAO_B	1	6	Accelerate	MaxClimb	ZERO		1 268,1	250	
A330-343	ICAO_B	1	7	Climb	MaxClimb	ZERO	5 500			
A330-343	ICAO_B	1	8	Climb	MaxClimb	ZERO	7 500			

ACFTID	Profile_ID	Stage Length	Step Number	Step Type	Thrust Rating	Flap_ID	End Point Altitude (ft)	Rate Of Climb (ft/min)	End Point CAS (kt)	Accelerate_Percent (%)
A330-343	ICAO_B	1	9	Climb	MaxClimb	ZERO	10 000			
A330-343	ICAO_B	2	1	Takeoff	MaxTakeoff	1+F				
A330-343	ICAO_B	2	2	Climb	MaxTakeoff	1+F	1 000			
A330-343	ICAO_B	2	3	Accelerate	MaxTakeoff	1+F		1 218,9	177,7	
A330-343	ICAO_B	2	4	Accelerate	MaxTakeoff	1		1 340,4	215	
A330-343	ICAO_B	2	5	Climb	MaxClimb	ZERO	3 000			
A330-343	ICAO_B	2	6	Accelerate	MaxClimb	ZERO		1 223,6	250	
A330-343	ICAO_B	2	7	Climb	MaxClimb	ZERO	5 500			
A330-343	ICAO_B	2	8	Climb	MaxClimb	ZERO	7 500			
A330-343	ICAO_B	2	9	Climb	MaxClimb	ZERO	10 000			
A330-343	ICAO_B	3	1	Takeoff	MaxTakeoff	1+F				
A330-343	ICAO_B	3	2	Climb	MaxTakeoff	1+F	1 000			
A330-343	ICAO_B	3	3	Accelerate	MaxTakeoff	1+F		1 181,2	180,4	
A330-343	ICAO_B	3	4	Accelerate	MaxTakeoff	1		1 296,6	216,1	
A330-343	ICAO_B	3	5	Climb	MaxClimb	ZERO	3 000			
A330-343	ICAO_B	3	6	Accelerate	MaxClimb	ZERO		1 180	250	
A330-343	ICAO_B	3	7	Climb	MaxClimb	ZERO	5 500			
A330-343	ICAO_B	3	8	Climb	MaxClimb	ZERO	7 500			
A330-343	ICAO_B	3	9	Climb	MaxClimb	ZERO	10 000			
A330-343	ICAO_B	4	1	Takeoff	MaxTakeoff	1+F				

ACFTID	Profile_ID	Stage Length	Step Number	Step Type	Thrust Rating	Flap_ID	End Point Altitude (ft)	Rate Of Climb (ft/min)	End Point CAS (kt)	Accelerate_Percent (%)
A330-343	ICAO_B	4	2	Climb	MaxTakeoff	1+F	1 000			
A330-343	ICAO_B	4	3	Accelerate	MaxTakeoff	1+F		1 115,2	185,2	
A330-343	ICAO_B	4	4	Accelerate	MaxTakeoff	1		1 224,1	218,3	
A330-343	ICAO_B	4	5	Climb	MaxClimb	ZERO	3 000			
A330-343	ICAO_B	4	6	Accelerate	MaxClimb	ZERO		1 108,4	250	
A330-343	ICAO_B	4	7	Climb	MaxClimb	ZERO	5 500			
A330-343	ICAO_B	4	8	Climb	MaxClimb	ZERO	7 500			
A330-343	ICAO_B	4	9	Climb	MaxClimb	ZERO	10 000			
A330-343	ICAO_B	5	1	Takeoff	MaxTakeoff	1+F				
A330-343	ICAO_B	5	2	Climb	MaxTakeoff	1+F	1 000			
A330-343	ICAO_B	5	3	Accelerate	MaxTakeoff	1+F		1 038,3	191,3	
A330-343	ICAO_B	5	4	Accelerate	MaxTakeoff	1		1 139,2	221,4	
A330-343	ICAO_B	5	5	Climb	MaxClimb	ZERO	3 000			
A330-343	ICAO_B	5	6	Accelerate	MaxClimb	ZERO		1 025,2	250	
A330-343	ICAO_B	5	7	Climb	MaxClimb	ZERO	5 500			
A330-343	ICAO_B	5	8	Climb	MaxClimb	ZERO	7 500			
A330-343	ICAO_B	5	9	Climb	MaxClimb	ZERO	10 000			
A330-343	ICAO_B	6	1	Takeoff	MaxTakeoff	1+F				
A330-343	ICAO_B	6	2	Climb	MaxTakeoff	1+F	1 000			
A330-343	ICAO_B	6	3	Accelerate	MaxTakeoff	1+F		962,8	197,3	

ACFTID	Profile_ID	Stage Length	Step Number	Step Type	Thrust Rating	Flap_ID	End Point Altitude (ft)	Rate Of Climb (ft/min)	End Point CAS (kt)	Accelerate_Percent (%)
A330-343	ICAO_B	6	4	Accelerate	MaxTakeoff	1		1 054,3	224,5	
A330-343	ICAO_B	6	5	Climb	MaxClimb	ZERO	3 000			
A330-343	ICAO_B	6	6	Accelerate	MaxClimb	ZERO		943,3	250	
A330-343	ICAO_B	6	7	Climb	MaxClimb	ZERO	5 500			
A330-343	ICAO_B	6	8	Climb	MaxClimb	ZERO	7 500			
A330-343	ICAO_B	6	9	Climb	MaxClimb	ZERO	10 000			
A330-343	ICAO_B	7	1	Takeoff	MaxTakeoff	1+F				
A330-343	ICAO_B	7	2	Climb	MaxTakeoff	1+F	1 000			
A330-343	ICAO_B	7	3	Accelerate	MaxTakeoff	1+F		869,5	200,8	
A330-343	ICAO_B	7	4	Accelerate	MaxTakeoff	1		948,6	225	
A330-343	ICAO_B	7	5	Climb	MaxClimb	ZERO	3 000			
A330-343	ICAO_B	7	6	Accelerate	MaxClimb	ZERO		842	250	
A330-343	ICAO_B	7	7	Climb	MaxClimb	ZERO	5 500			
A330-343	ICAO_B	7	8	Climb	MaxClimb	ZERO	7 500			
A330-343	ICAO_B	7	9	Climb	MaxClimb	ZERO	10 000			
A340-211	DEFAULT	1	1	Takeoff	MaxTakeoff	1+F				
A340-211	DEFAULT	1	2	Climb	MaxTakeoff	1+F	1 000			
A340-211	DEFAULT	1	3	Accelerate	MaxTakeoff	1+F		1 019,3	177,6	
A340-211	DEFAULT	1	4	Accelerate	MaxTakeoff	1		1 101,1	215,2	
A340-211	DEFAULT	1	5	Climb	MaxClimb	ZERO	3 000			

ACFTID	Profile_ID	Stage Length	Step Number	Step Type	Thrust Rating	Flap_ID	End Point Altitude (ft)	Rate Of Climb (ft/min)	End Point CAS (kt)	Accelerate_Percent (%)
A 340-211	DEFAULT	1	6	Accelerate	MaxClimb	ZERO		1 165,6	250	
A 340-211	DEFAULT	1	7	Climb	MaxClimb	ZERO	5 500			
A 340-211	DEFAULT	1	8	Climb	MaxClimb	ZERO	7 500			
A 340-211	DEFAULT	1	9	Climb	MaxClimb	ZERO	10 000			
A 340-211	DEFAULT	2	1	Takeoff	MaxTakeoff	1+F				
A 340-211	DEFAULT	2	2	Climb	MaxTakeoff	1+F	1 000			
A 340-211	DEFAULT	2	3	Accelerate	MaxTakeoff	1+F		973,9	180,5	
A 340-211	DEFAULT	2	4	Accelerate	MaxTakeoff	1		1 061,1	216,3	
A 340-211	DEFAULT	2	5	Climb	MaxClimb	ZERO	3 000			
A 340-211	DEFAULT	2	6	Accelerate	MaxClimb	ZERO		1 120,6	250	
A 340-211	DEFAULT	2	7	Climb	MaxClimb	ZERO	5 500			
A 340-211	DEFAULT	2	8	Climb	MaxClimb	ZERO	7 500			
A 340-211	DEFAULT	2	9	Climb	MaxClimb	ZERO	10 000			
A 340-211	DEFAULT	3	1	Takeoff	MaxTakeoff	1+F				
A 340-211	DEFAULT	3	2	Climb	MaxTakeoff	1+F	1 000			
A 340-211	DEFAULT	3	3	Accelerate	MaxTakeoff	1+F		930,2	183,1	
A 340-211	DEFAULT	3	4	Accelerate	MaxTakeoff	1		1 021,2	217,3	
A 340-211	DEFAULT	3	5	Climb	MaxClimb	ZERO	3 000			
A 340-211	DEFAULT	3	6	Accelerate	MaxClimb	ZERO		1 076,1	250	
A 340-211	DEFAULT	3	7	Climb	MaxClimb	ZERO	5 500			

ACFTID	Profile_ID	Stage Length	Step Number	Step Type	Thrust Rating	Flap_ID	End Point Altitude (ft)	Rate Of Climb (ft/min)	End Point CAS (kt)	Accelerate_Percent (%)
A 340-211	DEFAULT	3	8	Climb	MaxClimb	ZERO	7 500			
A 340-211	DEFAULT	3	9	Climb	MaxClimb	ZERO	10 000			
A 340-211	DEFAULT	4	1	Takeoff	MaxTakeoff	1+F				
A 340-211	DEFAULT	4	2	Climb	MaxTakeoff	1+F	1 000			
A 340-211	DEFAULT	4	3	Accelerate	MaxTakeoff	1+F		860,1	188,2	
A 340-211	DEFAULT	4	4	Accelerate	MaxTakeoff	1		955,9	219,5	
A 340-211	DEFAULT	4	5	Climb	MaxClimb	ZERO	3 000			
A 340-211	DEFAULT	4	6	Accelerate	MaxClimb	ZERO		1 003,9	250	
A 340-211	DEFAULT	4	7	Climb	MaxClimb	ZERO	5 500			
A 340-211	DEFAULT	4	8	Climb	MaxClimb	ZERO	7 500			
A 340-211	DEFAULT	4	9	Climb	MaxClimb	ZERO	10 000			
A 340-211	DEFAULT	5	1	Takeoff	MaxTakeoff	1+F				
A 340-211	DEFAULT	5	2	Climb	MaxTakeoff	1+F	1 000			
A 340-211	DEFAULT	5	3	Accelerate	MaxTakeoff	1+F		779,4	194,9	
A 340-211	DEFAULT	5	4	Accelerate	MaxTakeoff	1		879,4	222,9	
A 340-211	DEFAULT	5	5	Climb	MaxClimb	ZERO	3 000			
A 340-211	DEFAULT	5	6	Accelerate	MaxClimb	ZERO		920,2	250	
A 340-211	DEFAULT	5	7	Climb	MaxClimb	ZERO	5 500			
A 340-211	DEFAULT	5	8	Climb	MaxClimb	ZERO	7 500			
A 340-211	DEFAULT	5	9	Climb	MaxClimb	ZERO	10 000			

ACFTID	Profile_ID	Stage Length	Step Number	Step Type	Thrust Rating	Flap_ID	End Point Altitude (ft)	Rate Of Climb (ft/min)	End Point CAS (kt)	Accelerate_Percent (%)
A 340-211	DEFAULT	6	1	Takeoff	MaxTakeoff	1+F				
A 340-211	DEFAULT	6	2	Climb	MaxTakeoff	1+F	1 000			
A 340-211	DEFAULT	6	3	Accelerate	MaxTakeoff	1+F		705,2	199,2	
A 340-211	DEFAULT	6	4	Accelerate	MaxTakeoff	1		802	224,4	
A 340-211	DEFAULT	6	5	Climb	MaxClimb	ZERO	3 000			
A 340-211	DEFAULT	6	6	Accelerate	MaxClimb	ZERO		836,4	250	
A 340-211	DEFAULT	6	7	Climb	MaxClimb	ZERO	5 500			
A 340-211	DEFAULT	6	8	Climb	MaxClimb	ZERO	7 500			
A 340-211	DEFAULT	6	9	Climb	MaxClimb	ZERO	10 000			
A 340-211	DEFAULT	7	1	Takeoff	MaxTakeoff	1+F				
A 340-211	DEFAULT	7	2	Climb	MaxTakeoff	1+F	1 000			
A 340-211	DEFAULT	7	3	Accelerate	MaxTakeoff	1+F		519,8	199,2	
A 340-211	DEFAULT	7	4	Accelerate	MaxTakeoff	1		591,5	218,2	
A 340-211	DEFAULT	7	5	Accelerate	MaxTakeoff	1		653,7	223,4	
A 340-211	DEFAULT	7	6	Climb	MaxClimb	ZERO	3 000			
A 340-211	DEFAULT	7	7	Accelerate	MaxClimb	ZERO		622,6	250	
A 340-211	DEFAULT	7	8	Climb	MaxClimb	ZERO	5 500			
A 340-211	DEFAULT	7	9	Climb	MaxClimb	ZERO	7 500			
A 340-211	DEFAULT	7	10	Climb	MaxClimb	ZERO	10 000			
A 340-211	ICAO_A	1	1	Takeoff	MaxTakeoff	1+F				

ACFTID	Profile_ID	Stage Length	Step Number	Step Type	Thrust Rating	Flap_ID	End Point Altitude (ft)	Rate Of Climb (ft/min)	End Point CAS (kt)	Accelerate_Percent (%)
A340-211	ICAO_A	1	2	Climb	MaxTakeoff	1+F	1 500			
A340-211	ICAO_A	1	3	Climb	MaxClimb	1+F	3 000			
A340-211	ICAO_A	1	4	Accelerate	MaxClimb	1+F		832,3	177,4	
A340-211	ICAO_A	1	5	Accelerate	MaxClimb	1		890,6	206,8	
A340-211	ICAO_A	1	6	Accelerate	MaxClimb	ZERO		1 039,6	227,9	
A340-211	ICAO_A	1	7	Accelerate	MaxClimb	ZERO		1 154,4	250	
A340-211	ICAO_A	1	8	Climb	MaxClimb	ZERO	5 500			
A340-211	ICAO_A	1	9	Climb	MaxClimb	ZERO	7 500			
A340-211	ICAO_A	1	10	Climb	MaxClimb	ZERO	10 000			
A340-211	ICAO_A	2	1	Takeoff	MaxTakeoff	1+F				
A340-211	ICAO_A	2	2	Climb	MaxTakeoff	1+F	1 500			
A340-211	ICAO_A	2	3	Climb	MaxClimb	1+F	3 000			
A340-211	ICAO_A	2	4	Accelerate	MaxClimb	1+F		793	180,4	
A340-211	ICAO_A	2	5	Accelerate	MaxClimb	1		855,5	208,3	
A340-211	ICAO_A	2	6	Accelerate	MaxClimb	ZERO		999,1	228,5	
A340-211	ICAO_A	2	7	Accelerate	MaxClimb	ZERO		1 109,1	250	
A340-211	ICAO_A	2	8	Climb	MaxClimb	ZERO	5 500			
A340-211	ICAO_A	2	9	Climb	MaxClimb	ZERO	7 500			
A340-211	ICAO_A	2	10	Climb	MaxClimb	ZERO	10 000			
A340-211	ICAO_A	3	1	Takeoff	MaxTakeoff	1+F				

ACFTID	Profile_ID	Stage Length	Step Number	Step Type	Thrust Rating	Flap_ID	End Point Altitude (ft)	Rate Of Climb (ft/min)	End Point CAS (kt)	Accelerate_Percent (%)
A340-211	ICAO_A	3	2	Climb	MaxTakeoff	1+F	1 500			
A340-211	ICAO_A	3	3	Climb	MaxClimb	1+F	3 000			
A340-211	ICAO_A	3	4	Accelerate	MaxClimb	1+F		754,7	183	
A340-211	ICAO_A	3	5	Accelerate	MaxClimb	1		820,5	209,4	
A340-211	ICAO_A	3	6	Accelerate	MaxClimb	ZERO		959,1	228,8	
A340-211	ICAO_A	3	7	Accelerate	MaxClimb	ZERO		1 064,5	250	
A340-211	ICAO_A	3	8	Climb	MaxClimb	ZERO	5 500			
A340-211	ICAO_A	3	9	Climb	MaxClimb	ZERO	7 500			
A340-211	ICAO_A	3	10	Climb	MaxClimb	ZERO	10 000			
A340-211	ICAO_A	4	1	Takeoff	MaxTakeoff	1+F				
A340-211	ICAO_A	4	2	Climb	MaxTakeoff	1+F	1 500			
A340-211	ICAO_A	4	3	Climb	MaxClimb	1+F	3 000			
A340-211	ICAO_A	4	4	Accelerate	MaxClimb	1+F		690,8	188,1	
A340-211	ICAO_A	4	5	Accelerate	MaxClimb	1		763	212,2	
A340-211	ICAO_A	4	6	Accelerate	MaxClimb	ZERO		893,8	230	
A340-211	ICAO_A	4	7	Accelerate	MaxClimb	ZERO		991,5	250	
A340-211	ICAO_A	4	8	Climb	MaxClimb	ZERO	5 500			
A340-211	ICAO_A	4	9	Climb	MaxClimb	ZERO	7 500			
A340-211	ICAO_A	4	10	Climb	MaxClimb	ZERO	10 000			
A340-211	ICAO_A	5	1	Takeoff	MaxTakeoff	1+F				

ACFTID	Profile_ID	Stage Length	Step Number	Step Type	Thrust Rating	Flap_ID	End Point Altitude (ft)	Rate Of Climb (ft/min)	End Point CAS (kt)	Accelerate_Percent (%)
A340-211	ICAO_A	5	2	Climb	MaxTakeoff	1+F	1 500			
A340-211	ICAO_A	5	3	Climb	MaxClimb	1+F	3 000			
A340-211	ICAO_A	5	4	Accelerate	MaxClimb	1+F		621,5	194,8	
A340-211	ICAO_A	5	5	Accelerate	MaxClimb	1		695,5	216,1	
A340-211	ICAO_A	5	6	Accelerate	MaxClimb	ZERO		818,3	232,2	
A340-211	ICAO_A	5	7	Accelerate	MaxClimb	ZERO		906,8	250	
A340-211	ICAO_A	5	8	Climb	MaxClimb	ZERO	5 500			
A340-211	ICAO_A	5	9	Climb	MaxClimb	ZERO	7 500			
A340-211	ICAO_A	5	10	Climb	MaxClimb	ZERO	10 000			
A340-211	ICAO_A	6	1	Takeoff	MaxTakeoff	1+F				
A340-211	ICAO_A	6	2	Climb	MaxTakeoff	1+F	1 500			
A340-211	ICAO_A	6	3	Climb	MaxClimb	1+F	3 000			
A340-211	ICAO_A	6	4	Accelerate	MaxClimb	1+F		555,3	199,2	
A340-211	ICAO_A	6	5	Accelerate	MaxClimb	1		627,4	218,1	
A340-211	ICAO_A	6	6	Accelerate	MaxClimb	ZERO		742,5	232,6	
A340-211	ICAO_A	6	7	Accelerate	MaxClimb	ZERO		824,1	250	
A340-211	ICAO_A	6	8	Climb	MaxClimb	ZERO	5 500			
A340-211	ICAO_A	6	9	Climb	MaxClimb	ZERO	7 500			
A340-211	ICAO_A	6	10	Climb	MaxClimb	ZERO	10 000			
A340-211	ICAO_A	7	1	Takeoff	MaxTakeoff	1+F				

ACFTID	Profile_ID	Stage Length	Step Number	Step Type	Thrust Rating	Flap_ID	End Point Altitude (ft)	Rate Of Climb (ft/min)	End Point CAS (kt)	Accelerate_Percent (%)
A340-211	ICAO_A	7	2	Climb	MaxTakeoff	1+F	1 500			
A340-211	ICAO_A	7	3	Climb	MaxClimb	1+F	3 000			
A340-211	ICAO_A	7	4	Accelerate	MaxClimb	1+F		388,7	199,2	
A340-211	ICAO_A	7	5	Accelerate	MaxClimb	1		444,2	212,8	
A340-211	ICAO_A	7	6	Accelerate	MaxClimb	1		500,7	224,8	
A340-211	ICAO_A	7	7	Accelerate	MaxClimb	ZERO		555,6	235,4	
A340-211	ICAO_A	7	8	Accelerate	MaxClimb	ZERO		623	250	
A340-211	ICAO_A	7	9	Climb	MaxClimb	ZERO	5 500			
A340-211	ICAO_A	7	10	Climb	MaxClimb	ZERO	7 500			
A340-211	ICAO_A	7	11	Climb	MaxClimb	ZERO	10 000			
A340-211	ICAO_B	1	1	Takeoff	MaxTakeoff	1+F				
A340-211	ICAO_B	1	2	Climb	MaxTakeoff	1+F	1 000			
A340-211	ICAO_B	1	3	Accelerate	MaxTakeoff	1+F		1 019,3	177,6	
A340-211	ICAO_B	1	4	Accelerate	MaxTakeoff	1		1 101,1	215,2	
A340-211	ICAO_B	1	5	Climb	MaxClimb	ZERO	3 000			
A340-211	ICAO_B	1	6	Accelerate	MaxClimb	ZERO		1 165,6	250	
A340-211	ICAO_B	1	7	Climb	MaxClimb	ZERO	5 500			
A340-211	ICAO_B	1	8	Climb	MaxClimb	ZERO	7 500			
A340-211	ICAO_B	1	9	Climb	MaxClimb	ZERO	10 000			
A340-211	ICAO_B	2	1	Takeoff	MaxTakeoff	1+F				

ACFTID	Profile_ID	Stage Length	Step Number	Step Type	Thrust Rating	Flap_ID	End Point Altitude (ft)	Rate Of Climb (ft/min)	End Point CAS (kt)	Accelerate_Percent (%)
A340-211	ICAO_B	2	2	Climb	MaxTakeoff	1+F	1 000			
A340-211	ICAO_B	2	3	Accelerate	MaxTakeoff	1+F		973,9	180,5	
A340-211	ICAO_B	2	4	Accelerate	MaxTakeoff	1		1 061,1	216,3	
A340-211	ICAO_B	2	5	Climb	MaxClimb	ZERO	3 000			
A340-211	ICAO_B	2	6	Accelerate	MaxClimb	ZERO		1 120,6	250	
A340-211	ICAO_B	2	7	Climb	MaxClimb	ZERO	5 500			
A340-211	ICAO_B	2	8	Climb	MaxClimb	ZERO	7 500			
A340-211	ICAO_B	2	9	Climb	MaxClimb	ZERO	10 000			
A340-211	ICAO_B	3	1	Takeoff	MaxTakeoff	1+F				
A340-211	ICAO_B	3	2	Climb	MaxTakeoff	1+F	1 000			
A340-211	ICAO_B	3	3	Accelerate	MaxTakeoff	1+F		930,2	183,1	
A340-211	ICAO_B	3	4	Accelerate	MaxTakeoff	1		1 021,2	217,3	
A340-211	ICAO_B	3	5	Climb	MaxClimb	ZERO	3 000			
A340-211	ICAO_B	3	6	Accelerate	MaxClimb	ZERO		1 076,1	250	
A340-211	ICAO_B	3	7	Climb	MaxClimb	ZERO	5 500			
A340-211	ICAO_B	3	8	Climb	MaxClimb	ZERO	7 500			
A340-211	ICAO_B	3	9	Climb	MaxClimb	ZERO	10 000			
A340-211	ICAO_B	4	1	Takeoff	MaxTakeoff	1+F				
A340-211	ICAO_B	4	2	Climb	MaxTakeoff	1+F	1 000			
A340-211	ICAO_B	4	3	Accelerate	MaxTakeoff	1+F		860,1	188,2	

ACFTID	Profile_ID	Stage Length	Step Number	Step Type	Thrust Rating	Flap_ID	End Point Altitude (ft)	Rate Of Climb (ft/min)	End Point CAS (kt)	Accelerate_Percent (%)
A340-211	ICAO_B	4	4	Accelerate	MaxTakeoff	1		955,9	219,5	
A340-211	ICAO_B	4	5	Climb	MaxClimb	ZERO	3 000			
A340-211	ICAO_B	4	6	Accelerate	MaxClimb	ZERO		1 003,9	250	
A340-211	ICAO_B	4	7	Climb	MaxClimb	ZERO	5 500			
A340-211	ICAO_B	4	8	Climb	MaxClimb	ZERO	7 500			
A340-211	ICAO_B	4	9	Climb	MaxClimb	ZERO	10 000			
A340-211	ICAO_B	5	1	Takeoff	MaxTakeoff	1+F				
A340-211	ICAO_B	5	2	Climb	MaxTakeoff	1+F	1 000			
A340-211	ICAO_B	5	3	Accelerate	MaxTakeoff	1+F		779,4	194,9	
A340-211	ICAO_B	5	4	Accelerate	MaxTakeoff	1		879,4	222,9	
A340-211	ICAO_B	5	5	Climb	MaxClimb	ZERO	3 000			
A340-211	ICAO_B	5	6	Accelerate	MaxClimb	ZERO		920,2	250	
A340-211	ICAO_B	5	7	Climb	MaxClimb	ZERO	5 500			
A340-211	ICAO_B	5	8	Climb	MaxClimb	ZERO	7 500			
A340-211	ICAO_B	5	9	Climb	MaxClimb	ZERO	10 000			
A340-211	ICAO_B	6	1	Takeoff	MaxTakeoff	1+F				
A340-211	ICAO_B	6	2	Climb	MaxTakeoff	1+F	1 000			
A340-211	ICAO_B	6	3	Accelerate	MaxTakeoff	1+F		705,2	199,2	
A340-211	ICAO_B	6	4	Accelerate	MaxTakeoff	1		802	224,4	
A340-211	ICAO_B	6	5	Climb	MaxClimb	ZERO	3 000			

ACFTID	Profile_ID	Stage Length	Step Number	Step Type	Thrust Rating	Flap_ID	End Point Altitude (ft)	Rate Of Climb (ft/min)	End Point CAS (kt)	Accelerate_Percent (%)
A 340-211	ICAO_B	6	6	Accelerate	MaxClimb	ZERO		836,4	250	
A 340-211	ICAO_B	6	7	Climb	MaxClimb	ZERO	5 500			
A 340-211	ICAO_B	6	8	Climb	MaxClimb	ZERO	7 500			
A 340-211	ICAO_B	6	9	Climb	MaxClimb	ZERO	10 000			
A 340-211	ICAO_B	7	1	Takeoff	MaxTakeoff	1+F				
A 340-211	ICAO_B	7	2	Climb	MaxTakeoff	1+F	1 000			
A 340-211	ICAO_B	7	3	Accelerate	MaxTakeoff	1+F		519,8	199,2	
A 340-211	ICAO_B	7	4	Accelerate	MaxTakeoff	1		591,5	218,2	
A 340-211	ICAO_B	7	5	Accelerate	MaxTakeoff	1		653,7	223,4	
A 340-211	ICAO_B	7	6	Climb	MaxClimb	ZERO	3 000			
A 340-211	ICAO_B	7	7	Accelerate	MaxClimb	ZERO		622,6	250	
A 340-211	ICAO_B	7	8	Climb	MaxClimb	ZERO	5 500			
A 340-211	ICAO_B	7	9	Climb	MaxClimb	ZERO	7 500			
A 340-211	ICAO_B	7	10	Climb	MaxClimb	ZERO	10 000			
A 340-642	DEFAULT	1	1	Takeoff	MaxTakeoff	1+F				
A 340-642	DEFAULT	1	2	Accelerate	MaxTakeoff	1+F		1 518,1	178,9	
A 340-642	DEFAULT	1	3	Climb	MaxTakeoff	1+F	1 000			
A 340-642	DEFAULT	1	4	Accelerate	MaxTakeoff	1+F		1 534,7	191,5	
A 340-642	DEFAULT	1	5	Accelerate	MaxTakeoff	1		1 638,4	240,3	
A 340-642	DEFAULT	1	6	Climb	MaxClimb	ZERO	3 000			

ACFTID	Profile_ID	Stage Length	Step Number	Step Type	Thrust Rating	Flap_ID	End Point Altitude (ft)	Rate Of Climb (ft/min)	End Point CAS (kt)	Accelerate_Percent (%)
A340-642	DEFAULT	1	7	Accelerate	MaxClimb	ZERO		1 461,4	250	
A340-642	DEFAULT	1	8	Climb	MaxClimb	ZERO	5 500			
A340-642	DEFAULT	1	9	Climb	MaxClimb	ZERO	7 500			
A340-642	DEFAULT	1	10	Climb	MaxClimb	ZERO	10 000			
A340-642	DEFAULT	2	1	Takeoff	MaxTakeoff	1+F				
A340-642	DEFAULT	2	2	Accelerate	MaxTakeoff	1+F		1 481	178,3	
A340-642	DEFAULT	2	3	Climb	MaxTakeoff	1+F	1 000			
A340-642	DEFAULT	2	4	Accelerate	MaxTakeoff	1+F		1 452,6	194,6	
A340-642	DEFAULT	2	5	Accelerate	MaxTakeoff	1		1 595,8	241,6	
A340-642	DEFAULT	2	6	Climb	MaxClimb	ZERO	3 000			
A340-642	DEFAULT	2	7	Accelerate	MaxClimb	ZERO		1 415	250	
A340-642	DEFAULT	2	8	Climb	MaxClimb	ZERO	5 500			
A340-642	DEFAULT	2	9	Climb	MaxClimb	ZERO	7 500			
A340-642	DEFAULT	2	10	Climb	MaxClimb	ZERO	10 000			
A340-642	DEFAULT	3	1	Takeoff	MaxTakeoff	1+F				
A340-642	DEFAULT	3	2	Accelerate	MaxTakeoff	1+F		1 444,1	177,7	
A340-642	DEFAULT	3	3	Climb	MaxTakeoff	1+F	1 000			
A340-642	DEFAULT	3	4	Accelerate	MaxTakeoff	1+F		1 382,6	197,7	
A340-642	DEFAULT	3	5	Accelerate	MaxTakeoff	1		1 554,9	243	
A340-642	DEFAULT	3	6	Climb	MaxClimb	ZERO	3 000			

ACFTID	Profile_ID	Stage Length	Step Number	Step Type	Thrust Rating	Flap_ID	End Point Altitude (ft)	Rate Of Climb (ft/min)	End Point CAS (kt)	Accelerate_Percent (%)
A 340-642	DEFAULT	3	7	Accelerate	MaxClimb	ZERO		1 374,5	250	
A 340-642	DEFAULT	3	8	Climb	MaxClimb	ZERO	5 500			
A 340-642	DEFAULT	3	9	Climb	MaxClimb	ZERO	7 500			
A 340-642	DEFAULT	3	10	Climb	MaxClimb	ZERO	10 000			
A 340-642	DEFAULT	4	1	Takeoff	MaxTakeoff	1+F				
A 340-642	DEFAULT	4	2	Accelerate	MaxTakeoff	1+F		1 383,2	176,9	
A 340-642	DEFAULT	4	3	Climb	MaxTakeoff	1+F	1 000			
A 340-642	DEFAULT	4	4	Accelerate	MaxTakeoff	1+F		1 292	203	
A 340-642	DEFAULT	4	5	Accelerate	MaxTakeoff	1		1 478,5	245,2	
A 340-642	DEFAULT	4	6	Climb	MaxClimb	ZERO	3 000			
A 340-642	DEFAULT	4	7	Accelerate	MaxClimb	ZERO		1 320,3	250	
A 340-642	DEFAULT	4	8	Climb	MaxClimb	ZERO	5 500			
A 340-642	DEFAULT	4	9	Climb	MaxClimb	ZERO	7 500			
A 340-642	DEFAULT	4	10	Climb	MaxClimb	ZERO	10 000			
A 340-642	DEFAULT	5	1	Takeoff	MaxTakeoff	1+F				
A 340-642	DEFAULT	5	2	Accelerate	MaxTakeoff	1+F		1 327,9	180,6	
A 340-642	DEFAULT	5	3	Climb	MaxTakeoff	1+F	1 000			
A 340-642	DEFAULT	5	4	Accelerate	MaxTakeoff	1+F		1 209,7	210,1	
A 340-642	DEFAULT	5	5	Accelerate	MaxTakeoff	1		1 373,5	248,4	
A 340-642	DEFAULT	5	6	Climb	MaxClimb	ZERO	3 000			

ACFTID	Profile_ID	Stage Length	Step Number	Step Type	Thrust Rating	Flap_ID	End Point Altitude (ft)	Rate Of Climb (ft/min)	End Point CAS (kt)	Accelerate_Percent (%)
A340-642	DEFAULT	5	7	Accelerate	MaxClimb	ZERO		1 410,4	250	
A340-642	DEFAULT	5	8	Climb	MaxClimb	ZERO	5 500			
A340-642	DEFAULT	5	9	Climb	MaxClimb	ZERO	7 500			
A340-642	DEFAULT	5	10	Climb	MaxClimb	ZERO	10 000			
A340-642	DEFAULT	6	1	Takeoff	MaxTakeoff	1+F				
A340-642	DEFAULT	6	2	Accelerate	MaxTakeoff	1+F		1 185	185,4	
A340-642	DEFAULT	6	3	Climb	MaxTakeoff	1+F	1 000			
A340-642	DEFAULT	6	4	Accelerate	MaxTakeoff	1+F		1 126,6	214,9	
A340-642	DEFAULT	6	5	Accelerate	MaxTakeoff	1		1 268,8	249,8	
A340-642	DEFAULT	6	6	Climb	MaxClimb	ZERO	3 000			
A340-642	DEFAULT	6	7	Accelerate	MaxClimb	ZERO		2 048,9	250	
A340-642	DEFAULT	6	8	Climb	MaxClimb	ZERO	5 500			
A340-642	DEFAULT	6	9	Climb	MaxClimb	ZERO	7 500			
A340-642	DEFAULT	6	10	Climb	MaxClimb	ZERO	10 000			
A340-642	DEFAULT	7	1	Takeoff	MaxTakeoff	1+F				
A340-642	DEFAULT	7	2	Climb	MaxTakeoff	1+F	1 000			
A340-642	DEFAULT	7	3	Accelerate	MaxTakeoff	1+F		868,2	214,9	
A340-642	DEFAULT	7	4	Accelerate	MaxTakeoff	1		929,6	241,1	
A340-642	DEFAULT	7	5	Climb	MaxClimb	ZERO	3 000			
A340-642	DEFAULT	7	6	Accelerate	MaxClimb	ZERO		748,4	250	

ACFTID	Profile_ID	Stage Length	Step Number	Step Type	Thrust Rating	Flap_ID	End Point Altitude (ft)	Rate Of Climb (ft/min)	End Point CAS (kt)	Accelerate_Percent (%)
A340-642	DEFAULT	7	7	Climb	MaxClimb	ZERO	5 500			
A340-642	DEFAULT	7	8	Climb	MaxClimb	ZERO	7 500			
A340-642	DEFAULT	7	9	Climb	MaxClimb	ZERO	10 000			
A340-642	ICAO_A	1	1	Takeoff	MaxTakeoff	1+F				
A340-642	ICAO_A	1	2	Accelerate	MaxTakeoff	1+F		1 518,1	178,9	
A340-642	ICAO_A	1	3	Climb	MaxTakeoff	1+F	1 500			
A340-642	ICAO_A	1	4	Climb	MaxClimb	1+F	3 000			
A340-642	ICAO_A	1	5	Accelerate	MaxClimb	1+F		1 110,7	191,6	
A340-642	ICAO_A	1	6	Accelerate	MaxClimb	1		1 176,6	225,9	
A340-642	ICAO_A	1	7	Accelerate	MaxClimb	1		1 342,4	250	
A340-642	ICAO_A	1	8	Climb	MaxClimb	ZERO	5 500			
A340-642	ICAO_A	1	9	Climb	MaxClimb	ZERO	7 500			
A340-642	ICAO_A	1	10	Climb	MaxClimb	ZERO	10 000			
A340-642	ICAO_A	2	1	Takeoff	MaxTakeoff	1+F				
A340-642	ICAO_A	2	2	Accelerate	MaxTakeoff	1+F		1 481	178,3	
A340-642	ICAO_A	2	3	Climb	MaxTakeoff	1+F	1 500			
A340-642	ICAO_A	2	4	Climb	MaxClimb	1+F	3 000			
A340-642	ICAO_A	2	5	Accelerate	MaxClimb	1+F		1 053,1	194,6	
A340-642	ICAO_A	2	6	Accelerate	MaxClimb	1		1 135,6	227,4	
A340-642	ICAO_A	2	7	Accelerate	MaxClimb	1		1 292,5	250	

ACFTID	Profile_ID	Stage Length	Step Number	Step Type	Thrust Rating	Flap_ID	End Point Altitude (ft)	Rate Of Climb (ft/min)	End Point CAS (kt)	Accelerate_Percent (%)
A340-642	ICAO_A	2	8	Climb	MaxClimb	ZERO	5 500			
A340-642	ICAO_A	2	9	Climb	MaxClimb	ZERO	7 500			
A340-642	ICAO_A	2	10	Climb	MaxClimb	ZERO	10 000			
A340-642	ICAO_A	3	1	Takeoff	MaxTakeoff	1+F				
A340-642	ICAO_A	3	2	Accelerate	MaxTakeoff	1+F		1 444,1	177,7	
A340-642	ICAO_A	3	3	Climb	MaxTakeoff	1+F	1 500			
A340-642	ICAO_A	3	4	Climb	MaxClimb	1+F	3 000			
A340-642	ICAO_A	3	5	Accelerate	MaxClimb	1+F		1 002,2	197,7	
A340-642	ICAO_A	3	6	Accelerate	MaxClimb	1		1 095,6	228,9	
A340-642	ICAO_A	3	7	Accelerate	MaxClimb	1		1 243,9	250	
A340-642	ICAO_A	3	8	Climb	MaxClimb	ZERO	5 500			
A340-642	ICAO_A	3	9	Climb	MaxClimb	ZERO	7 500			
A340-642	ICAO_A	3	10	Climb	MaxClimb	ZERO	10 000			
A340-642	ICAO_A	4	1	Takeoff	MaxTakeoff	1+F				
A340-642	ICAO_A	4	2	Accelerate	MaxTakeoff	1+F		1 383,2	176,9	
A340-642	ICAO_A	4	3	Climb	MaxTakeoff	1+F	1 500			
A340-642	ICAO_A	4	4	Climb	MaxClimb	1+F	3 000			
A340-642	ICAO_A	4	5	Accelerate	MaxClimb	1+F		925,2	203,3	
A340-642	ICAO_A	4	6	Accelerate	MaxClimb	1		1 029,9	232	
A340-642	ICAO_A	4	7	Accelerate	MaxClimb	1		1 164	250	

ACFTID	Profile_ID	Stage Length	Step Number	Step Type	Thrust Rating	Flap_ID	End Point Altitude (ft)	Rate Of Climb (ft/min)	End Point CAS (kt)	Accelerate_Percent (%)
A340-642	ICAO_A	4	8	Climb	MaxClimb	ZERO	5 500			
A340-642	ICAO_A	4	9	Climb	MaxClimb	ZERO	7 500			
A340-642	ICAO_A	4	10	Climb	MaxClimb	ZERO	10 000			
A340-642	ICAO_A	5	1	Takeoff	MaxTakeoff	1+F				
A340-642	ICAO_A	5	2	Accelerate	MaxTakeoff	1+F		1 327,9	180,6	
A340-642	ICAO_A	5	3	Climb	MaxTakeoff	1+F	1 500			
A340-642	ICAO_A	5	4	Climb	MaxClimb	1+F	3 000			
A340-642	ICAO_A	5	5	Accelerate	MaxClimb	1+F		848,8	210,8	
A340-642	ICAO_A	5	6	Accelerate	MaxClimb	1		950,4	236,5	
A340-642	ICAO_A	5	7	Accelerate	MaxClimb	1		1 067,5	250	
A340-642	ICAO_A	5	8	Climb	MaxClimb	ZERO	5 500			
A340-642	ICAO_A	5	9	Climb	MaxClimb	ZERO	7 500			
A340-642	ICAO_A	5	10	Climb	MaxClimb	ZERO	10 000			
A340-642	ICAO_A	6	1	Takeoff	MaxTakeoff	1+F				
A340-642	ICAO_A	6	2	Accelerate	MaxTakeoff	1+F		1 185	185,4	
A340-642	ICAO_A	6	3	Climb	MaxTakeoff	1+F	1 500			
A340-642	ICAO_A	6	4	Climb	MaxClimb	1+F	3 000			
A340-642	ICAO_A	6	5	Accelerate	MaxClimb	1+F		780,5	219	
A340-642	ICAO_A	6	6	Accelerate	MaxClimb	1		875,9	242	
A340-642	ICAO_A	6	7	Accelerate	MaxClimb	1		975,3	250	

ACFTID	Profile_ID	Stage Length	Step Number	Step Type	Thrust Rating	Flap_ID	End Point Altitude (ft)	Rate Of Climb (ft/min)	End Point CAS (kt)	Accelerate_Percent (%)
A340-642	ICAO_A	6	8	Climb	MaxClimb	ZERO	5 500			
A340-642	ICAO_A	6	9	Climb	MaxClimb	ZERO	7 500			
A340-642	ICAO_A	6	10	Climb	MaxClimb	ZERO	10 000			
A340-642	ICAO_A	7	1	Takeoff	MaxTakeoff	1+F				
A340-642	ICAO_A	7	2	Climb	MaxTakeoff	1+F	1 500			
A340-642	ICAO_A	7	3	Climb	MaxClimb	1+F	3 000			
A340-642	ICAO_A	7	4	Accelerate	MaxClimb	1+F		556,7	214,9	
A340-642	ICAO_A	7	5	Accelerate	MaxClimb	1		601,9	231,3	
A340-642	ICAO_A	7	6	Accelerate	MaxClimb	ZERO		681,8	244	
A340-642	ICAO_A	7	7	Accelerate	MaxClimb	ZERO		729,1	250	
A340-642	ICAO_A	7	8	Climb	MaxClimb	ZERO	5 500			
A340-642	ICAO_A	7	9	Climb	MaxClimb	ZERO	7 500			
A340-642	ICAO_A	7	10	Climb	MaxClimb	ZERO	10 000			
A340-642	ICAO_B	1	1	Takeoff	MaxTakeoff	1+F				
A340-642	ICAO_B	1	2	Accelerate	MaxTakeoff	1+F		1 518,1	178,9	
A340-642	ICAO_B	1	3	Climb	MaxTakeoff	1+F	1 000			
A340-642	ICAO_B	1	4	Accelerate	MaxTakeoff	1+F		1 534,7	191,5	
A340-642	ICAO_B	1	5	Accelerate	MaxTakeoff	1		1 638,4	240,3	
A340-642	ICAO_B	1	6	Climb	MaxClimb	ZERO	3 000			
A340-642	ICAO_B	1	7	Accelerate	MaxClimb	ZERO		1 461,4	250	

ACFTID	Profile_ID	Stage Length	Step Number	Step Type	Thrust Rating	Flap_ID	End Point Altitude (ft)	Rate Of Climb (ft/min)	End Point CAS (kt)	Accelerate_Percent (%)
A340-642	ICAO_B	1	8	Climb	MaxClimb	ZERO	5 500			
A340-642	ICAO_B	1	9	Climb	MaxClimb	ZERO	7 500			
A340-642	ICAO_B	1	10	Climb	MaxClimb	ZERO	10 000			
A340-642	ICAO_B	2	1	Takeoff	MaxTakeoff	1+F				
A340-642	ICAO_B	2	2	Accelerate	MaxTakeoff	1+F		1 481	178,3	
A340-642	ICAO_B	2	3	Climb	MaxTakeoff	1+F	1 000			
A340-642	ICAO_B	2	4	Accelerate	MaxTakeoff	1+F		1 452,6	194,6	
A340-642	ICAO_B	2	5	Accelerate	MaxTakeoff	1		1 595,8	241,6	
A340-642	ICAO_B	2	6	Climb	MaxClimb	ZERO	3 000			
A340-642	ICAO_B	2	7	Accelerate	MaxClimb	ZERO		1 415	250	
A340-642	ICAO_B	2	8	Climb	MaxClimb	ZERO	5 500			
A340-642	ICAO_B	2	9	Climb	MaxClimb	ZERO	7 500			
A340-642	ICAO_B	2	10	Climb	MaxClimb	ZERO	10 000			
A340-642	ICAO_B	3	1	Takeoff	MaxTakeoff	1+F				
A340-642	ICAO_B	3	2	Accelerate	MaxTakeoff	1+F		1 444,1	177,7	
A340-642	ICAO_B	3	3	Climb	MaxTakeoff	1+F	1 000			
A340-642	ICAO_B	3	4	Accelerate	MaxTakeoff	1+F		1 382,6	197,7	
A340-642	ICAO_B	3	5	Accelerate	MaxTakeoff	1		1 554,9	243	
A340-642	ICAO_B	3	6	Climb	MaxClimb	ZERO	3 000			
A340-642	ICAO_B	3	7	Accelerate	MaxClimb	ZERO		1 374,5	250	

ACFTID	Profile_ID	Stage Length	Step Number	Step Type	Thrust Rating	Flap_ID	End Point Altitude (ft)	Rate Of Climb (ft/min)	End Point CAS (kt)	Accelerate_Percent (%)
A340-642	ICAO_B	3	8	Climb	MaxClimb	ZERO	5 500			
A340-642	ICAO_B	3	9	Climb	MaxClimb	ZERO	7 500			
A340-642	ICAO_B	3	10	Climb	MaxClimb	ZERO	10 000			
A340-642	ICAO_B	4	1	Takeoff	MaxTakeoff	1+F				
A340-642	ICAO_B	4	2	Accelerate	MaxTakeoff	1+F		1 383,2	176,9	
A340-642	ICAO_B	4	3	Climb	MaxTakeoff	1+F	1 000			
A340-642	ICAO_B	4	4	Accelerate	MaxTakeoff	1+F		1 292	203	
A340-642	ICAO_B	4	5	Accelerate	MaxTakeoff	1		1 478,5	245,2	
A340-642	ICAO_B	4	6	Climb	MaxClimb	ZERO	3 000			
A340-642	ICAO_B	4	7	Accelerate	MaxClimb	ZERO		1 320,3	250	
A340-642	ICAO_B	4	8	Climb	MaxClimb	ZERO	5 500			
A340-642	ICAO_B	4	9	Climb	MaxClimb	ZERO	7 500			
A340-642	ICAO_B	4	10	Climb	MaxClimb	ZERO	10 000			
A340-642	ICAO_B	5	1	Takeoff	MaxTakeoff	1+F				
A340-642	ICAO_B	5	2	Accelerate	MaxTakeoff	1+F		1 327,9	180,6	
A340-642	ICAO_B	5	3	Climb	MaxTakeoff	1+F	1 000			
A340-642	ICAO_B	5	4	Accelerate	MaxTakeoff	1+F		1 209,7	210,1	
A340-642	ICAO_B	5	5	Accelerate	MaxTakeoff	1		1 373,5	248,4	
A340-642	ICAO_B	5	6	Climb	MaxClimb	ZERO	3 000			
A340-642	ICAO_B	5	7	Accelerate	MaxClimb	ZERO		1 410,4	250	

ACFTID	Profile_ID	Stage Length	Step Number	Step Type	Thrust Rating	Flap_ID	End Point Altitude (ft)	Rate Of Climb (ft/min)	End Point CAS (kt)	Accelerate_Percent (%)
A340-642	ICAO_B	5	8	Climb	MaxClimb	ZERO	5 500			
A340-642	ICAO_B	5	9	Climb	MaxClimb	ZERO	7 500			
A340-642	ICAO_B	5	10	Climb	MaxClimb	ZERO	10 000			
A340-642	ICAO_B	6	1	Takeoff	MaxTakeoff	1+F				
A340-642	ICAO_B	6	2	Accelerate	MaxTakeoff	1+F		1 185	185,4	
A340-642	ICAO_B	6	3	Climb	MaxTakeoff	1+F	1 000			
A340-642	ICAO_B	6	4	Accelerate	MaxTakeoff	1+F		1 126,6	214,9	
A340-642	ICAO_B	6	5	Accelerate	MaxTakeoff	1		1 268,8	249,8	
A340-642	ICAO_B	6	6	Climb	MaxClimb	ZERO	3 000			
A340-642	ICAO_B	6	7	Accelerate	MaxClimb	ZERO		2 048,9	250	
A340-642	ICAO_B	6	8	Climb	MaxClimb	ZERO	5 500			
A340-642	ICAO_B	6	9	Climb	MaxClimb	ZERO	7 500			
A340-642	ICAO_B	6	10	Climb	MaxClimb	ZERO	10 000			
A340-642	ICAO_B	7	1	Takeoff	MaxTakeoff	1+F				
A340-642	ICAO_B	7	2	Climb	MaxTakeoff	1+F	1 000			
A340-642	ICAO_B	7	3	Accelerate	MaxTakeoff	1+F		868,2	214,9	
A340-642	ICAO_B	7	4	Accelerate	MaxTakeoff	1		929,6	241,1	
A340-642	ICAO_B	7	5	Climb	MaxClimb	ZERO	3 000			
A340-642	ICAO_B	7	6	Accelerate	MaxClimb	ZERO		748,4	250	
A340-642	ICAO_B	7	7	Climb	MaxClimb	ZERO	5 500			

ACFTID	Profile_ID	Stage Length	Step Number	Step Type	Thrust Rating	Flap_ID	End Point Altitude (ft)	Rate Of Climb (ft/min)	End Point CAS (kt)	Accelerate_Percent (%)
A340-642	ICAO_B	7	8	Climb	MaxClimb	ZERO	7 500			
A340-642	ICAO_B	7	9	Climb	MaxClimb	ZERO	10 000			
A380-841	DEFAULT	1	1	Takeoff	MaxTakeoff	D_1+F				
A380-841	DEFAULT	1	2	Climb	MaxTakeoff	D_1+F	1 000			
A380-841	DEFAULT	1	3	Accelerate	MaxTakeoff	D_1+F		1 085	175,1	
A380-841	DEFAULT	1	4	Accelerate	MaxTakeoff	D_1		1 306	238,9	
A380-841	DEFAULT	1	5	Climb	MaxClimb	D_1	3 000			
A380-841	DEFAULT	1	6	Accelerate	MaxClimb	ZERO		1 497,8	250	
A380-841	DEFAULT	1	7	Climb	MaxClimb	ZERO	10 000			
A380-841	DEFAULT	2	1	Takeoff	MaxTakeoff	D_1+F				
A380-841	DEFAULT	2	2	Climb	MaxTakeoff	D_1+F	1 000			
A380-841	DEFAULT	2	3	Accelerate	MaxTakeoff	D_1+F		1 054	177,6	
A380-841	DEFAULT	2	4	Accelerate	MaxTakeoff	D_1		1 262,8	238,9	
A380-841	DEFAULT	2	5	Climb	MaxClimb	D_1	3 000			
A380-841	DEFAULT	2	6	Accelerate	MaxClimb	ZERO		1 444,8	250	
A380-841	DEFAULT	2	7	Climb	MaxClimb	ZERO	10 000			
A380-841	DEFAULT	3	1	Takeoff	MaxTakeoff	D_1+F				
A380-841	DEFAULT	3	2	Climb	MaxTakeoff	D_1+F	1 000			
A380-841	DEFAULT	3	3	Accelerate	MaxTakeoff	D_1+F		1 022,1	180,2	
A380-841	DEFAULT	3	4	Accelerate	MaxTakeoff	D_1		1 220,9	239,1	

ACFTID	Profile_ID	Stage Length	Step Number	Step Type	Thrust Rating	Flap_ID	End Point Altitude (ft)	Rate Of Climb (ft/min)	End Point CAS (kt)	Accelerate_Percent (%)
A380-841	DEFAULT	3	5	Climb	MaxClimb	D_1	3 000			
A380-841	DEFAULT	3	6	Accelerate	MaxClimb	ZERO		1 394,3	250	
A380-841	DEFAULT	3	7	Climb	MaxClimb	ZERO	10 000			
A380-841	DEFAULT	4	1	Takeoff	MaxTakeoff	D_1+F				
A380-841	DEFAULT	4	2	Climb	MaxTakeoff	D_1+F	1 000			
A380-841	DEFAULT	4	3	Accelerate	MaxTakeoff	D_1+F		975,4	184,8	
A380-841	DEFAULT	4	4	Accelerate	MaxTakeoff	D_1		1 152,5	239,6	
A380-841	DEFAULT	4	5	Climb	MaxClimb	D_1	3 000			
A380-841	DEFAULT	4	6	Accelerate	MaxClimb	ZERO		1 313,6	250	
A380-841	DEFAULT	4	7	Climb	MaxClimb	ZERO	10 000			
A380-841	DEFAULT	5	1	Takeoff	MaxTakeoff	D_1+F				
A380-841	DEFAULT	5	2	Climb	MaxTakeoff	D_1+F	1 000			
A380-841	DEFAULT	5	3	Accelerate	MaxTakeoff	D_1+F		908,1	190,6	
A380-841	DEFAULT	5	4	Accelerate	MaxTakeoff	D_1		1 072,2	240,8	
A380-841	DEFAULT	5	5	Climb	MaxClimb	D_1	3 000			
A380-841	DEFAULT	5	6	Accelerate	MaxClimb	ZERO		1 220,7	250	
A380-841	DEFAULT	5	7	Climb	MaxClimb	ZERO	10 000			
A380-841	DEFAULT	6	1	Takeoff	MaxTakeoff	D_1+F				
A380-841	DEFAULT	6	2	Climb	MaxTakeoff	D_1+F	1 000			
A380-841	DEFAULT	6	3	Accelerate	MaxTakeoff	D_1+F		843	196,7	

ACFTID	Profile_ID	Stage Length	Step Number	Step Type	Thrust Rating	Flap_ID	End Point Altitude (ft)	Rate Of Climb (ft/min)	End Point CAS (kt)	Accelerate_Percent (%)
A380-841	DEFAULT	6	4	Accelerate	MaxTakeoff	D_1		994,4	242,4	
A380-841	DEFAULT	6	5	Climb	MaxClimb	D_1	3 000			
A380-841	DEFAULT	6	6	Accelerate	MaxClimb	ZERO		1 134,1	250	
A380-841	DEFAULT	6	7	Climb	MaxClimb	ZERO	10 000			
A380-841	DEFAULT	7	1	Takeoff	MaxTakeoff	D_1+F				
A380-841	DEFAULT	7	2	Climb	MaxTakeoff	D_1+F	1 000			
A380-841	DEFAULT	7	3	Accelerate	MaxTakeoff	D_1+F		783	202,7	
A380-841	DEFAULT	7	4	Accelerate	MaxTakeoff	D_1		925	244,4	
A380-841	DEFAULT	7	5	Climb	MaxClimb	D_1	3 000			
A380-841	DEFAULT	7	6	Accelerate	MaxClimb	ZERO		1 065,1	250	
A380-841	DEFAULT	7	7	Climb	MaxClimb	ZERO	10 000			
A380-841	DEFAULT	8	1	Takeoff	MaxTakeoff	D_1+F				
A380-841	DEFAULT	8	2	Climb	MaxTakeoff	D_1+F	1 000			
A380-841	DEFAULT	8	3	Accelerate	MaxTakeoff	D_1+F		622,4	220	
A380-841	DEFAULT	8	4	Accelerate	MaxTakeoff	D_1		744,8	251,7	
A380-841	DEFAULT	8	5	Climb	MaxClimb	D_1	3 000			
A380-841	DEFAULT	8	6	Climb	MaxClimb	ZERO	10 000			
A380-841	ICAO_A	1	1	Takeoff	MaxTakeoff	D_1+F				
A380-841	ICAO_A	1	2	Climb	MaxTakeoff	D_1+F	1 500			
A380-841	ICAO_A	1	3	Climb	MaxClimb	D_1+F	3 000			

ACFTID	Profile_ID	Stage Length	Step Number	Step Type	Thrust Rating	Flap_ID	End Point Altitude (ft)	Rate Of Climb (ft/min)	End Point CAS (kt)	Accelerate_Percent (%)
A380-841	ICAO_A	1	4	Accelerate	MaxClimb	D_1		1 049,1	175,1	
A380-841	ICAO_A	1	5	Accelerate	MaxClimb	D_1		1 257,9	233,9	
A380-841	ICAO_A	1	6	Accelerate	MaxClimb	ZERO		1 403,3	250	
A380-841	ICAO_A	1	7	Climb	MaxClimb	ZERO	10 000			
A380-841	ICAO_A	2	1	Takeoff	MaxTakeoff	D_1+F				
A380-841	ICAO_A	2	2	Climb	MaxTakeoff	D_1+F	1 500			
A380-841	ICAO_A	2	3	Climb	MaxClimb	D_1+F	3 000			
A380-841	ICAO_A	2	4	Accelerate	MaxClimb	D_1		1 005,4	177,7	
A380-841	ICAO_A	2	5	Accelerate	MaxClimb	D_1		1 217,2	234,1	
A380-841	ICAO_A	2	6	Accelerate	MaxClimb	ZERO		1 355,3	250	
A380-841	ICAO_A	2	7	Climb	MaxClimb	ZERO	10 000			
A380-841	ICAO_A	3	1	Takeoff	MaxTakeoff	D_1+F				
A380-841	ICAO_A	3	2	Climb	MaxTakeoff	D_1+F	1 500			
A380-841	ICAO_A	3	3	Climb	MaxClimb	D_1+F	3 000			
A380-841	ICAO_A	3	4	Accelerate	MaxClimb	D_1		965,1	180,3	
A380-841	ICAO_A	3	5	Accelerate	MaxClimb	D_1		1 177,8	234,5	
A380-841	ICAO_A	3	6	Accelerate	MaxClimb	ZERO		1 308,6	250	
A380-841	ICAO_A	3	7	Climb	MaxClimb	ZERO	10 000			
A380-841	ICAO_A	4	1	Takeoff	MaxTakeoff	D_1+F				
A380-841	ICAO_A	4	2	Climb	MaxTakeoff	D_1+F	1 500			

ACFTID	Profile_ID	Stage Length	Step Number	Step Type	Thrust Rating	Flap_ID	End Point Altitude (ft)	Rate Of Climb (ft/min)	End Point CAS (kt)	Accelerate_Percent (%)
A380-841	ICAO_A	4	3	Climb	MaxClimb	D_1+F	3 000			
A380-841	ICAO_A	4	4	Accelerate	MaxClimb	D_1		912,3	184,9	
A380-841	ICAO_A	4	5	Accelerate	MaxClimb	D_1		1 113,9	235,4	
A380-841	ICAO_A	4	6	Accelerate	MaxClimb	ZERO		1 231,9	250	
A380-841	ICAO_A	4	7	Climb	MaxClimb	ZERO	10 000			
A380-841	ICAO_A	5	1	Takeoff	MaxTakeoff	D_1+F				
A380-841	ICAO_A	5	2	Climb	MaxTakeoff	D_1+F	1 500			
A380-841	ICAO_A	5	3	Climb	MaxClimb	D_1+F	3 000			
A380-841	ICAO_A	5	4	Accelerate	MaxClimb	D_1		850,1	190,8	
A380-841	ICAO_A	5	5	Accelerate	MaxClimb	D_1		1 038,8	237,1	
A380-841	ICAO_A	5	6	Accelerate	MaxClimb	ZERO		1 141,2	250	
A380-841	ICAO_A	5	7	Climb	MaxClimb	ZERO	10 000			
A380-841	ICAO_A	6	1	Takeoff	MaxTakeoff	D_1+F				
A380-841	ICAO_A	6	2	Climb	MaxTakeoff	D_1+F	1 500			
A380-841	ICAO_A	6	3	Climb	MaxClimb	D_1+F	3 000			
A380-841	ICAO_A	6	4	Accelerate	MaxClimb	D_1		789,5	196,9	
A380-841	ICAO_A	6	5	Accelerate	MaxClimb	D_1		965,9	239,1	
A380-841	ICAO_A	6	6	Accelerate	MaxClimb	ZERO		1 053	250	
A380-841	ICAO_A	6	7	Climb	MaxClimb	ZERO	10 000			
A380-841	ICAO_A	7	1	Takeoff	MaxTakeoff	D_1+F				

ACFTID	Profile_ID	Stage Length	Step Number	Step Type	Thrust Rating	Flap_ID	End Point Altitude (ft)	Rate Of Climb (ft/min)	End Point CAS (kt)	Accelerate_Percent (%)
A380-841	ICAO_A	7	2	Climb	MaxTakeoff	D_1+F	1 500			
A380-841	ICAO_A	7	3	Climb	MaxClimb	D_1+F	3 000			
A380-841	ICAO_A	7	4	Accelerate	MaxClimb	D_1		735,4	203,1	
A380-841	ICAO_A	7	5	Accelerate	MaxClimb	D_1		900,3	241,6	
A380-841	ICAO_A	7	6	Accelerate	MaxClimb	ZERO		973,7	250	
A380-841	ICAO_A	7	7	Climb	MaxClimb	ZERO	10 000			
A380-841	ICAO_A	8	1	Takeoff	MaxTakeoff	D_1+F				
A380-841	ICAO_A	8	2	Climb	MaxTakeoff	D_1+F	1 500			
A380-841	ICAO_A	8	3	Climb	MaxClimb	D_1+F	3 000			
A380-841	ICAO_A	8	4	Accelerate	MaxClimb	D_1		587,9	220	
A380-841	ICAO_A	8	5	Accelerate	MaxClimb	D_1		722,8	249,2	
A380-841	ICAO_A	8	6	Accelerate	MaxClimb	ZERO		762,6	250	
A380-841	ICAO_A	8	7	Climb	MaxClimb	ZERO	10 000			
A380-841	ICAO_B	1	1	Takeoff	MaxTakeoff	D_1+F				
A380-841	ICAO_B	1	2	Climb	MaxTakeoff	D_1+F	1 000			
A380-841	ICAO_B	1	3	Accelerate	MaxTakeoff	D_1+F		1 085	175,1	
A380-841	ICAO_B	1	4	Accelerate	MaxTakeoff	D_1		1 306	238,9	
A380-841	ICAO_B	1	5	Climb	MaxClimb	D_1	3 000			
A380-841	ICAO_B	1	6	Accelerate	MaxClimb	ZERO		1 497,8	250	
A380-841	ICAO_B	1	7	Climb	MaxClimb	ZERO	10 000			

ACFTID	Profile_ID	Stage Length	Step Number	Step Type	Thrust Rating	Flap_ID	End Point Altitude (ft)	Rate Of Climb (ft/min)	End Point CAS (kt)	Accelerate_Percent (%)
A380-841	ICAO_B	2	1	Takeoff	MaxTakeoff	D_1+F				
A380-841	ICAO_B	2	2	Climb	MaxTakeoff	D_1+F	1 000			
A380-841	ICAO_B	2	3	Accelerate	MaxTakeoff	D_1+F		1 054	177,6	
A380-841	ICAO_B	2	4	Accelerate	MaxTakeoff	D_1		1 262,8	238,9	
A380-841	ICAO_B	2	5	Climb	MaxClimb	D_1	3 000			
A380-841	ICAO_B	2	6	Accelerate	MaxClimb	ZERO		1 444,8	250	
A380-841	ICAO_B	2	7	Climb	MaxClimb	ZERO	10 000			
A380-841	ICAO_B	3	1	Takeoff	MaxTakeoff	D_1+F				
A380-841	ICAO_B	3	2	Climb	MaxTakeoff	D_1+F	1 000			
A380-841	ICAO_B	3	3	Accelerate	MaxTakeoff	D_1+F		1 022,1	180,2	
A380-841	ICAO_B	3	4	Accelerate	MaxTakeoff	D_1		1 220,9	239,1	
A380-841	ICAO_B	3	5	Climb	MaxClimb	D_1	3 000			
A380-841	ICAO_B	3	6	Accelerate	MaxClimb	ZERO		1 394,3	250	
A380-841	ICAO_B	3	7	Climb	MaxClimb	ZERO	10 000			
A380-841	ICAO_B	4	1	Takeoff	MaxTakeoff	D_1+F				
A380-841	ICAO_B	4	2	Climb	MaxTakeoff	D_1+F	1 000			
A380-841	ICAO_B	4	3	Accelerate	MaxTakeoff	D_1+F		975,4	184,8	
A380-841	ICAO_B	4	4	Accelerate	MaxTakeoff	D_1		1 152,5	239,6	
A380-841	ICAO_B	4	5	Climb	MaxClimb	D_1	3 000			
A380-841	ICAO_B	4	6	Accelerate	MaxClimb	ZERO		1 313,6	250	

ACFTID	Profile_ID	Stage Length	Step Number	Step Type	Thrust Rating	Flap_ID	End Point Altitude (ft)	Rate Of Climb (ft/min)	End Point CAS (kt)	Accelerate_Percent (%)
A380-841	ICAO_B	4	7	Climb	MaxClimb	ZERO	10 000			
A380-841	ICAO_B	5	1	Takeoff	MaxTakeoff	D_1+F				
A380-841	ICAO_B	5	2	Climb	MaxTakeoff	D_1+F	1 000			
A380-841	ICAO_B	5	3	Accelerate	MaxTakeoff	D_1+F		908,1	190,6	
A380-841	ICAO_B	5	4	Accelerate	MaxTakeoff	D_1		1 072,2	240,8	
A380-841	ICAO_B	5	5	Climb	MaxClimb	D_1	3 000			
A380-841	ICAO_B	5	6	Accelerate	MaxClimb	ZERO		1 220,7	250	
A380-841	ICAO_B	5	7	Climb	MaxClimb	ZERO	10 000			
A380-841	ICAO_B	6	1	Takeoff	MaxTakeoff	D_1+F				
A380-841	ICAO_B	6	2	Climb	MaxTakeoff	D_1+F	1 000			
A380-841	ICAO_B	6	3	Accelerate	MaxTakeoff	D_1+F		843	196,7	
A380-841	ICAO_B	6	4	Accelerate	MaxTakeoff	D_1		994,4	242,4	
A380-841	ICAO_B	6	5	Climb	MaxClimb	D_1	3 000			
A380-841	ICAO_B	6	6	Accelerate	MaxClimb	ZERO		1 134,1	250	
A380-841	ICAO_B	6	7	Climb	MaxClimb	ZERO	10 000			
A380-841	ICAO_B	7	1	Takeoff	MaxTakeoff	D_1+F				
A380-841	ICAO_B	7	2	Climb	MaxTakeoff	D_1+F	1 000			
A380-841	ICAO_B	7	3	Accelerate	MaxTakeoff	D_1+F		783	202,7	
A380-841	ICAO_B	7	4	Accelerate	MaxTakeoff	D_1		925	244,4	
A380-841	ICAO_B	7	5	Climb	MaxClimb	D_1	3 000			

ACFTID	Profile_ID	Stage Length	Step Number	Step Type	Thrust Rating	Flap_ID	End Point Altitude (ft)	Rate Of Climb (ft/min)	End Point CAS (kt)	Accelerate_Percent (%)
A380-841	ICAO_B	7	6	Accelerate	MaxClimb	ZERO		1 065,1	250	
A380-841	ICAO_B	7	7	Climb	MaxClimb	ZERO	10 000			
A380-841	ICAO_B	8	1	Takeoff	MaxTakeoff	D_1+F				
A380-841	ICAO_B	8	2	Climb	MaxTakeoff	D_1+F	1 000			
A380-841	ICAO_B	8	3	Accelerate	MaxTakeoff	D_1+F		622,4	220	
A380-841	ICAO_B	8	4	Accelerate	MaxTakeoff	D_1		744,8	251,7	
A380-841	ICAO_B	8	5	Climb	MaxClimb	D_1	3 000			
A380-841	ICAO_B	8	6	Climb	MaxClimb	ZERO	10 000			
A380-861	DEFAULT	1	1	Takeoff	MaxTakeoff	D_1+F				
A380-861	DEFAULT	1	2	Climb	MaxTakeoff	D_1+F	1 000			
A380-861	DEFAULT	1	3	Accelerate	MaxTakeoff	D_1+F		1 086	175,1	
A380-861	DEFAULT	1	4	Accelerate	MaxTakeoff	D_1		1 312,2	239,2	
A380-861	DEFAULT	1	5	Climb	MaxClimb	D_1	3 000			
A380-861	DEFAULT	1	6	Accelerate	MaxClimb	ZERO		1 499,1	250	
A380-861	DEFAULT	1	7	Climb	MaxClimb	ZERO	10 000			
A380-861	DEFAULT	2	1	Takeoff	MaxTakeoff	D_1+F				
A380-861	DEFAULT	2	2	Climb	MaxTakeoff	D_1+F	1 000			
A380-861	DEFAULT	2	3	Accelerate	MaxTakeoff	D_1+F		1 056	177,6	
A380-861	DEFAULT	2	4	Accelerate	MaxTakeoff	D_1		1 269	239,2	
A380-861	DEFAULT	2	5	Climb	MaxClimb	D_1	3 000			

ACFTID	Profile_ID	Stage Length	Step Number	Step Type	Thrust Rating	Flap_ID	End Point Altitude (ft)	Rate Of Climb (ft/min)	End Point CAS (kt)	Accelerate_Percent (%)
A380-861	DEFAULT	2	6	Accelerate	MaxClimb	ZERO		1 446,4	250	
A380-861	DEFAULT	2	7	Climb	MaxClimb	ZERO	10 000			
A380-861	DEFAULT	3	1	Takeoff	MaxTakeoff	D_1+F				
A380-861	DEFAULT	3	2	Climb	MaxTakeoff	D_1+F	1 000			
A380-861	DEFAULT	3	3	Accelerate	MaxTakeoff	D_1+F		1 024,4	180,2	
A380-861	DEFAULT	3	4	Accelerate	MaxTakeoff	D_1		1 226,4	239,2	
A380-861	DEFAULT	3	5	Climb	MaxClimb	D_1	3 000			
A380-861	DEFAULT	3	6	Accelerate	MaxClimb	ZERO		1 394,9	250	
A380-861	DEFAULT	3	7	Climb	MaxClimb	ZERO	10 000			
A380-861	DEFAULT	4	1	Takeoff	MaxTakeoff	D_1+F				
A380-861	DEFAULT	4	2	Climb	MaxTakeoff	D_1+F	1 000			
A380-861	DEFAULT	4	3	Accelerate	MaxTakeoff	D_1+F		972,5	184,7	
A380-861	DEFAULT	4	4	Accelerate	MaxTakeoff	D_1		1 158,3	239,8	
A380-861	DEFAULT	4	5	Climb	MaxClimb	D_1	3 000			
A380-861	DEFAULT	4	6	Accelerate	MaxClimb	ZERO		1 315,9	250	
A380-861	DEFAULT	4	7	Climb	MaxClimb	ZERO	10 000			
A380-861	DEFAULT	5	1	Takeoff	MaxTakeoff	D_1+F				
A380-861	DEFAULT	5	2	Climb	MaxTakeoff	D_1+F	1 000			
A380-861	DEFAULT	5	3	Accelerate	MaxTakeoff	D_1+F		906,2	190,4	
A380-861	DEFAULT	5	4	Accelerate	MaxTakeoff	D_1		1 080,4	240,9	

ACFTID	Profile_ID	Stage Length	Step Number	Step Type	Thrust Rating	Flap_ID	End Point Altitude (ft)	Rate Of Climb (ft/min)	End Point CAS (kt)	Accelerate_Percent (%)
A380-861	DEFAULT	5	5	Climb	MaxClimb	D_1	3 000			
A380-861	DEFAULT	5	6	Accelerate	MaxClimb	ZERO		1 225,2	250	
A380-861	DEFAULT	5	7	Climb	MaxClimb	ZERO	10 000			
A380-861	DEFAULT	6	1	Takeoff	MaxTakeoff	D_1+F				
A380-861	DEFAULT	6	2	Climb	MaxTakeoff	D_1+F	1 000			
A380-861	DEFAULT	6	3	Accelerate	MaxTakeoff	D_1+F		840	196,4	
A380-861	DEFAULT	6	4	Accelerate	MaxTakeoff	D_1		1 003	242,5	
A380-861	DEFAULT	6	5	Climb	MaxClimb	D_1	3 000			
A380-861	DEFAULT	6	6	Accelerate	MaxClimb	ZERO		1 139	250	
A380-861	DEFAULT	6	7	Climb	MaxClimb	ZERO	10 000			
A380-861	DEFAULT	7	1	Takeoff	MaxTakeoff	D_1+F				
A380-861	DEFAULT	7	2	Climb	MaxTakeoff	D_1+F	1 000			
A380-861	DEFAULT	7	3	Accelerate	MaxTakeoff	D_1+F		777,6	202,7	
A380-861	DEFAULT	7	4	Accelerate	MaxTakeoff	D_1		930,4	244,6	
A380-861	DEFAULT	7	5	Climb	MaxClimb	D_1	3 000			
A380-861	DEFAULT	7	6	Accelerate	MaxClimb	ZERO		1 063,2	250	
A380-861	DEFAULT	7	7	Climb	MaxClimb	ZERO	10 000			
A380-861	DEFAULT	8	1	Takeoff	MaxTakeoff	D_1+F				
A380-861	DEFAULT	8	2	Climb	MaxTakeoff	D_1+F	1 000			
A380-861	DEFAULT	8	3	Accelerate	MaxTakeoff	D_1+F		618,5	220	

ACFTID	Profile_ID	Stage Length	Step Number	Step Type	Thrust Rating	Flap_ID	End Point Altitude (ft)	Rate Of Climb (ft/min)	End Point CAS (kt)	Accelerate_Percent (%)
A380-861	DEFAULT	8	4	Accelerate	MaxTakeoff	D_1		746,6	251,8	
A380-861	DEFAULT	8	5	Climb	MaxClimb	D_1	3 000			
A380-861	DEFAULT	8	6	Climb	MaxClimb	ZERO	10 000			
A380-861	ICAO_A	1	1	Takeoff	MaxTakeoff	D_1+F				
A380-861	ICAO_A	1	2	Climb	MaxTakeoff	D_1+F	1 500			
A380-861	ICAO_A	1	3	Climb	MaxClimb	D_1+F	3 000			
A380-861	ICAO_A	1	4	Accelerate	MaxClimb	D_1		1 057,7	175,1	
A380-861	ICAO_A	1	5	Accelerate	MaxClimb	D_1		1 257,2	233,9	
A380-861	ICAO_A	1	6	Accelerate	MaxClimb	ZERO		1 386,8	250	
A380-861	ICAO_A	1	7	Climb	MaxClimb	ZERO	10 000			
A380-861	ICAO_A	2	1	Takeoff	MaxTakeoff	D_1+F				
A380-861	ICAO_A	2	2	Climb	MaxTakeoff	D_1+F	1 500			
A380-861	ICAO_A	2	3	Climb	MaxClimb	D_1+F	3 000			
A380-861	ICAO_A	2	4	Accelerate	MaxClimb	D_1		1 012,5	177,6	
A380-861	ICAO_A	2	5	Accelerate	MaxClimb	D_1		1 208,1	233,8	
A380-861	ICAO_A	2	6	Accelerate	MaxClimb	ZERO		1 339,4	250	
A380-861	ICAO_A	2	7	Climb	MaxClimb	ZERO	10 000			
A380-861	ICAO_A	3	1	Takeoff	MaxTakeoff	D_1+F				
A380-861	ICAO_A	3	2	Climb	MaxTakeoff	D_1+F	1 500			
A380-861	ICAO_A	3	3	Climb	MaxClimb	D_1+F	3 000			

ACFTID	Profile_ID	Stage Length	Step Number	Step Type	Thrust Rating	Flap_ID	End Point Altitude (ft)	Rate Of Climb (ft/min)	End Point CAS (kt)	Accelerate_Percent (%)
A380-861	ICAO_A	3	4	Accelerate	MaxClimb	D_1		970	180,2	
A380-861	ICAO_A	3	5	Accelerate	MaxClimb	D_1		1 168,2	234,1	
A380-861	ICAO_A	3	6	Accelerate	MaxClimb	ZERO		1 293	250	
A380-861	ICAO_A	3	7	Climb	MaxClimb	ZERO	10 000			
A380-861	ICAO_A	4	1	Takeoff	MaxTakeoff	D_1+F				
A380-861	ICAO_A	4	2	Climb	MaxTakeoff	D_1+F	1 500			
A380-861	ICAO_A	4	3	Climb	MaxClimb	D_1+F	3 000			
A380-861	ICAO_A	4	4	Accelerate	MaxClimb	D_1		908,4	184,8	
A380-861	ICAO_A	4	5	Accelerate	MaxClimb	D_1		1 103,5	235	
A380-861	ICAO_A	4	6	Accelerate	MaxClimb	ZERO		1 216,8	250	
A380-861	ICAO_A	4	7	Climb	MaxClimb	ZERO	10 000			
A380-861	ICAO_A	5	1	Takeoff	MaxTakeoff	D_1+F				
A380-861	ICAO_A	5	2	Climb	MaxTakeoff	D_1+F	1 500			
A380-861	ICAO_A	5	3	Climb	MaxClimb	D_1+F	3 000			
A380-861	ICAO_A	5	4	Accelerate	MaxClimb	D_1		847,3	190,5	
A380-861	ICAO_A	5	5	Accelerate	MaxClimb	D_1		1 029,6	236,5	
A380-861	ICAO_A	5	6	Accelerate	MaxClimb	ZERO		1 129,4	250	
A380-861	ICAO_A	5	7	Climb	MaxClimb	ZERO	10 000			
A380-861	ICAO_A	6	1	Takeoff	MaxTakeoff	D_1+F				
A380-861	ICAO_A	6	2	Climb	MaxTakeoff	D_1+F	1 500			

ACFTID	Profile_ID	Stage Length	Step Number	Step Type	Thrust Rating	Flap_ID	End Point Altitude (ft)	Rate Of Climb (ft/min)	End Point CAS (kt)	Accelerate_Percent (%)
A380-861	ICAO_A	6	3	Climb	MaxClimb	D_1+F	3 000			
A380-861	ICAO_A	6	4	Accelerate	MaxClimb	D_1		786	196,7	
A380-861	ICAO_A	6	5	Accelerate	MaxClimb	D_1		955,7	238,5	
A380-861	ICAO_A	6	6	Accelerate	MaxClimb	ZERO		1 041,8	250	
A380-861	ICAO_A	6	7	Climb	MaxClimb	ZERO	10 000			
A380-861	ICAO_A	7	1	Takeoff	MaxTakeoff	D_1+F				
A380-861	ICAO_A	7	2	Climb	MaxTakeoff	D_1+F	1 500			
A380-861	ICAO_A	7	3	Climb	MaxClimb	D_1+F	3 000			
A380-861	ICAO_A	7	4	Accelerate	MaxClimb	D_1		728,1	203,1	
A380-861	ICAO_A	7	5	Accelerate	MaxClimb	D_1		886,1	241,1	
A380-861	ICAO_A	7	6	Accelerate	MaxClimb	ZERO		959,3	250	
A380-861	ICAO_A	7	7	Climb	MaxClimb	ZERO	10 000			
A380-861	ICAO_A	8	1	Takeoff	MaxTakeoff	D_1+F				
A380-861	ICAO_A	8	2	Climb	MaxTakeoff	D_1+F	1 500			
A380-861	ICAO_A	8	3	Climb	MaxClimb	D_1+F	3 000			
A380-861	ICAO_A	8	4	Accelerate	MaxClimb	D_1		577,2	220	
A380-861	ICAO_A	8	5	Accelerate	MaxClimb	D_1		705,6	248,6	
A380-861	ICAO_A	8	6	Accelerate	MaxClimb	ZERO		749,1	250	
A380-861	ICAO_A	8	7	Climb	MaxClimb	ZERO	10 000			
A380-861	ICAO_B	1	1	Takeoff	MaxTakeoff	D_1+F				

ACFTID	Profile_ID	Stage Length	Step Number	Step Type	Thrust Rating	Flap_ID	End Point Altitude (ft)	Rate Of Climb (ft/min)	End Point CAS (kt)	Accelerate_Percent (%)
A380-861	ICAO_B	1	2	Climb	MaxTakeoff	D_1+F	1 000			
A380-861	ICAO_B	1	3	Accelerate	MaxTakeoff	D_1+F		1 086	175,1	
A380-861	ICAO_B	1	4	Accelerate	MaxTakeoff	D_1		1 312,2	239,2	
A380-861	ICAO_B	1	5	Climb	MaxClimb	D_1	3 000			
A380-861	ICAO_B	1	6	Accelerate	MaxClimb	ZERO		1 499,1	250	
A380-861	ICAO_B	1	7	Climb	MaxClimb	ZERO	10 000			
A380-861	ICAO_B	2	1	Takeoff	MaxTakeoff	D_1+F				
A380-861	ICAO_B	2	2	Climb	MaxTakeoff	D_1+F	1 000			
A380-861	ICAO_B	2	3	Accelerate	MaxTakeoff	D_1+F		1 056	177,6	
A380-861	ICAO_B	2	4	Accelerate	MaxTakeoff	D_1		1 269	239,2	
A380-861	ICAO_B	2	5	Climb	MaxClimb	D_1	3 000			
A380-861	ICAO_B	2	6	Accelerate	MaxClimb	ZERO		1 446,4	250	
A380-861	ICAO_B	2	7	Climb	MaxClimb	ZERO	10 000			
A380-861	ICAO_B	3	1	Takeoff	MaxTakeoff	D_1+F				
A380-861	ICAO_B	3	2	Climb	MaxTakeoff	D_1+F	1 000			
A380-861	ICAO_B	3	3	Accelerate	MaxTakeoff	D_1+F		1 024,4	180,2	
A380-861	ICAO_B	3	4	Accelerate	MaxTakeoff	D_1		1 226,4	239,2	
A380-861	ICAO_B	3	5	Climb	MaxClimb	D_1	3 000			
A380-861	ICAO_B	3	6	Accelerate	MaxClimb	ZERO		1 394,9	250	
A380-861	ICAO_B	3	7	Climb	MaxClimb	ZERO	10 000			

ACFTID	Profile_ID	Stage Length	Step Number	Step Type	Thrust Rating	Flap_ID	End Point Altitude (ft)	Rate Of Climb (ft/min)	End Point CAS (kt)	Accelerate_Percent (%)
A380-861	ICAO_B	4	1	Takeoff	MaxTakeoff	D_1+F				
A380-861	ICAO_B	4	2	Climb	MaxTakeoff	D_1+F	1 000			
A380-861	ICAO_B	4	3	Accelerate	MaxTakeoff	D_1+F		972,5	184,7	
A380-861	ICAO_B	4	4	Accelerate	MaxTakeoff	D_1		1 158,3	239,8	
A380-861	ICAO_B	4	5	Climb	MaxClimb	D_1	3 000			
A380-861	ICAO_B	4	6	Accelerate	MaxClimb	ZERO		1 315,9	250	
A380-861	ICAO_B	4	7	Climb	MaxClimb	ZERO	10 000			
A380-861	ICAO_B	5	1	Takeoff	MaxTakeoff	D_1+F				
A380-861	ICAO_B	5	2	Climb	MaxTakeoff	D_1+F	1 000			
A380-861	ICAO_B	5	3	Accelerate	MaxTakeoff	D_1+F		906,2	190,4	
A380-861	ICAO_B	5	4	Accelerate	MaxTakeoff	D_1		1 080,4	240,9	
A380-861	ICAO_B	5	5	Climb	MaxClimb	D_1	3 000			
A380-861	ICAO_B	5	6	Accelerate	MaxClimb	ZERO		1 225,2	250	
A380-861	ICAO_B	5	7	Climb	MaxClimb	ZERO	10 000			
A380-861	ICAO_B	6	1	Takeoff	MaxTakeoff	D_1+F				
A380-861	ICAO_B	6	2	Climb	MaxTakeoff	D_1+F	1 000			
A380-861	ICAO_B	6	3	Accelerate	MaxTakeoff	D_1+F		840	196,4	
A380-861	ICAO_B	6	4	Accelerate	MaxTakeoff	D_1		1 003	242,5	
A380-861	ICAO_B	6	5	Climb	MaxClimb	D_1	3 000			
A380-861	ICAO_B	6	6	Accelerate	MaxClimb	ZERO		1 139	250	

ACFTID	Profile_ID	Stage Length	Step Number	Step Type	Thrust Rating	Flap_ID	End Point Altitude (ft)	Rate Of Climb (ft/min)	End Point CAS (kt)	Accelerate_Percent (%)
A380-861	ICAO_B	6	7	Climb	MaxClimb	ZERO	10 000			
A380-861	ICAO_B	7	1	Takeoff	MaxTakeoff	D_1+F				
A380-861	ICAO_B	7	2	Climb	MaxTakeoff	D_1+F	1 000			
A380-861	ICAO_B	7	3	Accelerate	MaxTakeoff	D_1+F		777,6	202,7	
A380-861	ICAO_B	7	4	Accelerate	MaxTakeoff	D_1		930,4	244,6	
A380-861	ICAO_B	7	5	Climb	MaxClimb	D_1	3 000			
A380-861	ICAO_B	7	6	Accelerate	MaxClimb	ZERO		1 063,2	250	
A380-861	ICAO_B	7	7	Climb	MaxClimb	ZERO	10 000			
A380-861	ICAO_B	8	1	Takeoff	MaxTakeoff	D_1+F				
A380-861	ICAO_B	8	2	Climb	MaxTakeoff	D_1+F	1 000			
A380-861	ICAO_B	8	3	Accelerate	MaxTakeoff	D_1+F		618,5	220	
A380-861	ICAO_B	8	4	Accelerate	MaxTakeoff	D_1		746,6	251,8	
A380-861	ICAO_B	8	5	Climb	MaxClimb	D_1	3 000			
A380-861	ICAO_B	8	6	Climb	MaxClimb	ZERO	10 000			
BAC111	DEFAULT	1	1	Takeoff	MaxTakeoff	8				
BAC111	DEFAULT	1	2	Climb	MaxTakeoff	8	1 000			
BAC111	DEFAULT	1	3	Accelerate	MaxTakeoff	8		1 942	158	
BAC111	DEFAULT	1	4	Accelerate	MaxTakeoff	INT1		1 457	178	
BAC111	DEFAULT	1	5	Accelerate	MaxClimb	INT1		1 000	198	
BAC111	DEFAULT	1	6	Climb	MaxClimb	ZERO	3 000			

ACFTID	Profile_ID	Stage Length	Step Number	Step Type	Thrust Rating	Flap_ID	End Point Altitude (ft)	Rate Of Climb (ft/min)	End Point CAS (kt)	Accelerate_Percent (%)
BAC111	DEFAULT	1	7	Accelerate	MaxClimb	ZERO		1 000	250	
BAC111	DEFAULT	1	8	Climb	MaxClimb	ZERO	5 500			
BAC111	DEFAULT	1	9	Climb	MaxClimb	ZERO	7 500			
BAC111	DEFAULT	1	10	Climb	MaxClimb	ZERO	10 000			
BAC111	DEFAULT	2	1	Takeoff	MaxTakeoff	8				
BAC111	DEFAULT	2	2	Climb	MaxTakeoff	8	1 000			
BAC111	DEFAULT	2	3	Accelerate	MaxTakeoff	8		1 809	163	
BAC111	DEFAULT	2	4	Accelerate	MaxTakeoff	INT1		1 357	183	
BAC111	DEFAULT	2	5	Accelerate	MaxClimb	INT1		1 000	203	
BAC111	DEFAULT	2	6	Climb	MaxClimb	ZERO	3 000			
BAC111	DEFAULT	2	7	Accelerate	MaxClimb	ZERO		1 000	250	
BAC111	DEFAULT	2	8	Climb	MaxClimb	ZERO	5 500			
BAC111	DEFAULT	2	9	Climb	MaxClimb	ZERO	7 500			
BAC111	DEFAULT	2	10	Climb	MaxClimb	ZERO	10 000			
BAC111	DEFAULT	3	1	Takeoff	MaxTakeoff	8				
BAC111	DEFAULT	3	2	Climb	MaxTakeoff	8	1 000			
BAC111	DEFAULT	3	3	Accelerate	MaxTakeoff	8		1 665	169	
BAC111	DEFAULT	3	4	Accelerate	MaxTakeoff	INT1		1 249	189	
BAC111	DEFAULT	3	5	Accelerate	MaxClimb	INT1		1 000	209	
BAC111	DEFAULT	3	6	Climb	MaxClimb	ZERO	3 000			

ACFTID	Profile_ID	Stage Length	Step Number	Step Type	Thrust Rating	Flap_ID	End Point Altitude (ft)	Rate Of Climb (ft/min)	End Point CAS (kt)	Accelerate_Percent (%)
BAC111	DEFAULT	3	7	Accelerate	MaxClimb	ZERO		1 000	250	
BAC111	DEFAULT	3	8	Climb	MaxClimb	ZERO	5 500			
BAC111	DEFAULT	3	9	Climb	MaxClimb	ZERO	7 500			
BAC111	DEFAULT	3	10	Climb	MaxClimb	ZERO	10 000			
BAE146	DEFAULT	1	1	Takeoff	MaxTakeoff	18				
BAE146	DEFAULT	1	2	Climb	MaxTakeoff	18	1 000			
BAE146	DEFAULT	1	3	Accelerate	MaxTakeoff	18		970	171	
BAE146	DEFAULT	1	4	Accelerate	MaxClimb	ZERO		900	201	
BAE146	DEFAULT	1	5	Climb	MaxClimb	ZERO	3 000			
BAE146	DEFAULT	1	6	Accelerate	MaxClimb	ZERO		900	250	
BAE146	DEFAULT	1	7	Climb	MaxClimb	ZERO	5 500			
BAE146	DEFAULT	1	8	Climb	MaxClimb	ZERO	7 500			
BAE146	DEFAULT	1	9	Climb	MaxClimb	ZERO	10 000			
BAE146	DEFAULT	2	1	Takeoff	MaxTakeoff	18				
BAE146	DEFAULT	2	2	Climb	MaxTakeoff	18	1 000			
BAE146	DEFAULT	2	3	Accelerate	MaxTakeoff	18		801	178	
BAE146	DEFAULT	2	4	Accelerate	MaxClimb	ZERO		750	208	
BAE146	DEFAULT	2	5	Climb	MaxClimb	ZERO	3 000			
BAE146	DEFAULT	2	6	Accelerate	MaxClimb	ZERO		750	250	
BAE146	DEFAULT	2	7	Climb	MaxClimb	ZERO	5 500			

ACFTID	Profile_ID	Stage Length	Step Number	Step Type	Thrust Rating	Flap_ID	End Point Altitude (ft)	Rate Of Climb (ft/min)	End Point CAS (kt)	Accelerate_Percent (%)
BAE146	DEFAULT	2	8	Climb	MaxClimb	ZERO	7 500			
BAE146	DEFAULT	2	9	Climb	MaxClimb	ZERO	10 000			
BAE146	DEFAULT	3	1	Takeoff	MaxTakeoff	18				
BAE146	DEFAULT	3	2	Climb	MaxTakeoff	18	1 000			
BAE146	DEFAULT	3	3	Accelerate	MaxTakeoff	18		671	184	
BAE146	DEFAULT	3	4	Accelerate	MaxClimb	ZERO		500	214	
BAE146	DEFAULT	3	5	Climb	MaxClimb	ZERO	3 000			
BAE146	DEFAULT	3	6	Accelerate	MaxClimb	ZERO		500	250	
BAE146	DEFAULT	3	7	Climb	MaxClimb	ZERO	5 500			
BAE146	DEFAULT	3	8	Climb	MaxClimb	ZERO	7 500			
BAE146	DEFAULT	3	9	Climb	MaxClimb	ZERO	10 000			
BAE300	DEFAULT	1	1	Takeoff	MaxTakeoff	18				
BAE300	DEFAULT	1	2	Climb	MaxTakeoff	18	1 000			
BAE300	DEFAULT	1	3	Accelerate	MaxTakeoff	18		920	176	
BAE300	DEFAULT	1	4	Accelerate	MaxClimb	ZERO		900	206	
BAE300	DEFAULT	1	5	Climb	MaxClimb	ZERO	3 000			
BAE300	DEFAULT	1	6	Accelerate	MaxClimb	ZERO		900	250	
BAE300	DEFAULT	1	7	Climb	MaxClimb	ZERO	5 500			
BAE300	DEFAULT	1	8	Climb	MaxClimb	ZERO	7 500			
BAE300	DEFAULT	1	9	Climb	MaxClimb	ZERO	10 000			

ACFTID	Profile_ID	Stage Length	Step Number	Step Type	Thrust Rating	Flap_ID	End Point Altitude (ft)	Rate Of Climb (ft/min)	End Point CAS (kt)	Accelerate_Percent (%)
BAE300	DEFAULT	2	1	Takeoff	MaxTakeoff	18				
BAE300	DEFAULT	2	2	Climb	MaxTakeoff	18	1 000			
BAE300	DEFAULT	2	3	Accelerate	MaxTakeoff	18		762	183	
BAE300	DEFAULT	2	4	Accelerate	MaxClimb	ZERO		750	213	
BAE300	DEFAULT	2	5	Climb	MaxClimb	ZERO	3 000			
BAE300	DEFAULT	2	6	Accelerate	MaxClimb	ZERO		750	250	
BAE300	DEFAULT	2	7	Climb	MaxClimb	ZERO	5 500			
BAE300	DEFAULT	2	8	Climb	MaxClimb	ZERO	7 500			
BAE300	DEFAULT	2	9	Climb	MaxClimb	ZERO	10 000			
BAE300	DEFAULT	3	1	Takeoff	MaxTakeoff	18				
BAE300	DEFAULT	3	2	Climb	MaxTakeoff	18	1 000			
BAE300	DEFAULT	3	3	Accelerate	MaxTakeoff	18		622	189	
BAE300	DEFAULT	3	4	Accelerate	MaxClimb	ZERO		500	219	
BAE300	DEFAULT	3	5	Climb	MaxClimb	ZERO	3 000			
BAE300	DEFAULT	3	6	Accelerate	MaxClimb	ZERO		500	250	
BAE300	DEFAULT	3	7	Climb	MaxClimb	ZERO	5 500			
BAE300	DEFAULT	3	8	Climb	MaxClimb	ZERO	7 500			
BAE300	DEFAULT	3	9	Climb	MaxClimb	ZERO	10 000			
BEC58P	DEFAULT	1	1	Takeoff	MaxTakeoff	TO				
BEC58P	DEFAULT	1	2	Accelerate	MaxTakeoff	TO		1 040	115	

ACFTID	Profile_ID	Stage Length	Step Number	Step Type	Thrust Rating	Flap_ID	End Point Altitude (ft)	Rate Of Climb (ft/min)	End Point CAS (kt)	Accelerate_Percent (%)
BEC58P	DEFAULT	1	3	Climb	MaxTakeoff	TO	1 000			
BEC58P	DEFAULT	1	4	Accelerate	MaxTakeoff	TO		1 040	130	
BEC58P	DEFAULT	1	5	Climb	MaxClimb	ZERO	3 000			
BEC58P	DEFAULT	1	6	Climb	MaxClimb	ZERO	5 500			
BEC58P	DEFAULT	1	7	Climb	MaxClimb	ZERO	7 500			
BEC58P	DEFAULT	1	8	Climb	MaxClimb	ZERO	10 000			
CIT3	DEFAULT	1	1	Takeoff	MaxTakeoff	20				
CIT3	DEFAULT	1	2	Accelerate	MaxTakeoff	20		1 146	149	
CIT3	DEFAULT	1	3	Climb	MaxTakeoff	20	1 500			
CIT3	DEFAULT	1	4	Accelerate	MaxTakeoff	10		1 146	174	
CIT3	DEFAULT	1	5	Climb	MaxClimb	ZERO	3 000			
CIT3	DEFAULT	1	6	Accelerate	MaxClimb	ZERO		1 503	250	
CIT3	DEFAULT	1	7	Climb	MaxClimb	ZERO	5 500			
CIT3	DEFAULT	1	8	Climb	MaxClimb	ZERO	7 500			
CIT3	DEFAULT	1	9	Climb	MaxClimb	ZERO	10 000			
CL600	DEFAULT	1	1	Takeoff	MaxTakeoff	20				
CL600	DEFAULT	1	2	Accelerate	MaxTakeoff	20		1 554	163	
CL600	DEFAULT	1	3	Climb	MaxTakeoff	20	1 500			
CL600	DEFAULT	1	4	Accelerate	MaxTakeoff	10		1 554	200	
CL600	DEFAULT	1	5	Climb	MaxClimb	ZERO	3 000			

ACFTID	Profile_ID	Stage Length	Step Number	Step Type	Thrust Rating	Flap_ID	End Point Altitude (ft)	Rate Of Climb (ft/min)	End Point CAS (kt)	Accelerate_Percent (%)
CL600	DEFAULT	1	6	Accelerate	MaxClimb	ZERO		1 771	250	
CL600	DEFAULT	1	7	Climb	MaxClimb	ZERO	5 500			
CL600	DEFAULT	1	8	Climb	MaxClimb	ZERO	7 500			
CL600	DEFAULT	1	9	Climb	MaxClimb	ZERO	10 000			
CL601	DEFAULT	1	1	Takeoff	MaxTakeoff	20				
CL601	DEFAULT	1	2	Accelerate	MaxTakeoff	20		1 673	177	
CL601	DEFAULT	1	3	Climb	MaxTakeoff	20	1 500			
CL601	DEFAULT	1	4	Accelerate	MaxTakeoff	10		1 673	200	
CL601	DEFAULT	1	5	Climb	MaxClimb	ZERO	3 000			
CL601	DEFAULT	1	6	Accelerate	MaxClimb	ZERO		1 724	250	
CL601	DEFAULT	1	7	Climb	MaxClimb	ZERO	5 500			
CL601	DEFAULT	1	8	Climb	MaxClimb	ZERO	7 500			
CL601	DEFAULT	1	9	Climb	MaxClimb	ZERO	10 000			
CNA172	DEFAULT	1	1	Takeoff	MaxTakeoff	ZERO-C				
CNA172	DEFAULT	1	2	Accelerate	MaxTakeoff	ZERO-C		500	75	
CNA172	DEFAULT	1	3	Climb	MaxTakeoff	ZERO-C	1 000			
CNA172	DEFAULT	1	4	Accelerate	MaxTakeoff	ZERO-C		500	80	
CNA172	DEFAULT	1	5	Climb	MaxClimb	ZERO-C	3 000			
CNA172	DEFAULT	1	6	Climb	MaxClimb	ZERO-C	5 000			
CNA172	DEFAULT	1	7	Climb	MaxClimb	ZERO-C	8 000			

ACFTID	Profile_ID	Stage Length	Step Number	Step Type	Thrust Rating	Flap_ID	End Point Altitude (ft)	Rate Of Climb (ft/min)	End Point CAS (kt)	Accelerate_Percent (%)
CNA182	DEFAULT	1	1	Takeoff	MaxTakeoff	F-20D				
CNA182	DEFAULT	1	2	Accelerate	MaxTakeoff	F-20D		500	80	
CNA182	DEFAULT	1	3	Climb	MaxTakeoff	ZERO	1 000			
CNA182	DEFAULT	1	4	Accelerate	MaxTakeoff	ZERO		500	85	
CNA182	DEFAULT	1	5	Climb	MaxClimb	ZERO	3 000			
CNA182	DEFAULT	1	6	Climb	MaxClimb	ZERO	5 000			
CNA182	DEFAULT	1	7	Climb	MaxClimb	ZERO	8 000			
CNA182	DEFAULT	1	8	Climb	MaxClimb	ZERO	10 000			
CNA208	DEFAULT	1	1	Takeoff	MaxTakeoff	F-20D				
CNA208	DEFAULT	1	2	Accelerate	MaxTakeoff	F-20D		915	104	
CNA208	DEFAULT	1	3	Climb	MaxTakeoff	ZERO	1 000			
CNA208	DEFAULT	1	4	Accelerate	MaxClimb	ZERO		846	115	
CNA208	DEFAULT	1	5	Climb	MaxClimb	ZERO	2 000			
CNA208	DEFAULT	1	6	Climb	MaxClimb	ZERO	4 000			
CNA208	DEFAULT	1	7	Climb	MaxClimb	ZERO	6 000			
CNA208	DEFAULT	1	8	Climb	MaxClimb	ZERO	8 000			
CNA208	DEFAULT	1	9	Climb	MaxClimb	ZERO	10 000			
CNA441	DEFAULT	1	1	Takeoff	MaxTakeoff	TO				
CNA441	DEFAULT	1	2	Accelerate	MaxTakeoff	TO		1 216	120	
CNA441	DEFAULT	1	3	Accelerate	MaxTakeoff	ZERO		1 216	140	

ACFTID	Profile_ID	Stage Length	Step Number	Step Type	Thrust Rating	Flap_ID	End Point Altitude (ft)	Rate Of Climb (ft/min)	End Point CAS (kt)	Accelerate_Percent (%)
CNA441	DEFAULT	1	4	Climb	MaxTakeoff	ZERO	3 000			
CNA441	DEFAULT	1	5	Climb	MaxClimb	ZERO	5 500			
CNA441	DEFAULT	1	6	Climb	MaxClimb	ZERO	7 500			
CNA441	DEFAULT	1	7	Climb	MaxClimb	ZERO	10 000			
CNA500	DEFAULT	1	1	Takeoff	MaxTakeoff	12				
CNA500	DEFAULT	1	2	Accelerate	MaxTakeoff	12		997	131	
CNA500	DEFAULT	1	3	Climb	MaxTakeoff	12	1 500			
CNA500	DEFAULT	1	4	Accelerate	MaxTakeoff	1		997	200	
CNA500	DEFAULT	1	5	Climb	MaxClimb	ZERO	3 000			
CNA500	DEFAULT	1	6	Accelerate	MaxClimb	ZERO		1 459	250	
CNA500	DEFAULT	1	7	Climb	MaxClimb	ZERO	5 500			
CNA500	DEFAULT	1	8	Climb	MaxClimb	ZERO	7 500			
CNA500	DEFAULT	1	9	Climb	MaxClimb	ZERO	10 000			
CNA510	DEFAULT	1	1	Takeoff	MaxTakeoff	D_15				
CNA510	DEFAULT	1	2	Climb	MaxTakeoff	D_15	535			
CNA510	DEFAULT	1	3	Accelerate	MaxTakeoff	D_15		1 500	138,3	
CNA510	DEFAULT	1	4	Climb	MaxTakeoff	D_15	1 500			
CNA510	DEFAULT	1	5	Accelerate	MaxClimb	ZERO_C		1 500	171	
CNA510	DEFAULT	1	6	Climb	MaxClimb	ZERO_C	3 000			
CNA510	DEFAULT	1	7	Accelerate	MaxClimb	ZERO_C		1 000	250	

ACFTID	Profile_ID	Stage Length	Step Number	Step Type	Thrust Rating	Flap_ID	End Point Altitude (ft)	Rate Of Climb (ft/min)	End Point CAS (kt)	Accelerate_Percent (%)
CNA510	DEFAULT	1	8	Climb	MaxClimb	ZERO_C	5 500			
CNA510	DEFAULT	1	9	Climb	MaxClimb	ZERO_C	7 500			
CNA510	DEFAULT	1	10	Climb	MaxClimb	ZERO_C	10 000			
CNA510	FLAPS_0	1	1	Takeoff	MaxTakeoff	ZERO_D				
CNA510	FLAPS_0	1	2	Climb	MaxTakeoff	ZERO_D	601			
CNA510	FLAPS_0	1	3	Accelerate	MaxTakeoff	ZERO_D		1 500	138,3	
CNA510	FLAPS_0	1	4	Climb	MaxTakeoff	ZERO_D	1 500			
CNA510	FLAPS_0	1	5	Accelerate	MaxClimb	ZERO_C		1 500	171	
CNA510	FLAPS_0	1	6	Climb	MaxClimb	ZERO_C	3 000			
CNA510	FLAPS_0	1	7	Accelerate	MaxClimb	ZERO_C		1 000	250	
CNA510	FLAPS_0	1	8	Climb	MaxClimb	ZERO_C	5 500			
CNA510	FLAPS_0	1	9	Climb	MaxClimb	ZERO_C	7 500			
CNA510	FLAPS_0	1	10	Climb	MaxClimb	ZERO_C	10 000			
CNA510	FLAPS_15	1	1	Takeoff	MaxTakeoff	D_15				
CNA510	FLAPS_15	1	2	Climb	MaxTakeoff	D_15	535			
CNA510	FLAPS_15	1	3	Accelerate	MaxTakeoff	D_15		1 500	138,3	
CNA510	FLAPS_15	1	4	Climb	MaxTakeoff	D_15	1 500			
CNA510	FLAPS_15	1	5	Accelerate	MaxClimb	ZERO_C		1 500	171	
CNA510	FLAPS_15	1	6	Climb	MaxClimb	ZERO_C	3 000			
CNA510	FLAPS_15	1	7	Accelerate	MaxClimb	ZERO_C		1 000	250	

ACFTID	Profile_ID	Stage Length	Step Number	Step Type	Thrust Rating	Flap_ID	End Point Altitude (ft)	Rate Of Climb (ft/min)	End Point CAS (kt)	Accelerate_Percent (%)
CNA510	FLAPS_15	1	8	Climb	MaxClimb	ZERO_C	5 500			
CNA510	FLAPS_15	1	9	Climb	MaxClimb	ZERO_C	7 500			
CNA510	FLAPS_15	1	10	Climb	MaxClimb	ZERO_C	10 000			
CNA525C	DEFAULT	1	1	Takeoff	MaxTakeoff	D-15				
CNA525C	DEFAULT	1	2	Climb	MaxTakeoff	D-15	482,5			
CNA525C	DEFAULT	1	3	Accelerate	MaxTakeoff	D-15		1 500	140,3	
CNA525C	DEFAULT	1	4	Climb	MaxTakeoff	D-15	1 500			
CNA525C	DEFAULT	1	5	Accelerate	MaxClimb	ZERO_C		1 500	171	
CNA525C	DEFAULT	1	6	Climb	MaxClimb	ZERO_C	3 000			
CNA525C	DEFAULT	1	7	Accelerate	MaxClimb	ZERO_C		1 000	250	
CNA525C	DEFAULT	1	8	Climb	MaxClimb	ZERO_C	5 500			
CNA525C	DEFAULT	1	9	Climb	MaxClimb	ZERO_C	7 500			
CNA525C	DEFAULT	1	10	Climb	MaxClimb	ZERO_C	10 000			
CNA55B	DEFAULT	1	1	Takeoff	MaxTakeoff	D_15				
CNA55B	DEFAULT	1	2	Climb	MaxTakeoff	D_15	379			
CNA55B	DEFAULT	1	3	Accelerate	MaxTakeoff	D_15		1 500	146,5	
CNA55B	DEFAULT	1	4	Climb	MaxTakeoff	D_15	1 500			
CNA55B	DEFAULT	1	5	Accelerate	MaxClimb	ZERO_C		1 500	171,5	
CNA55B	DEFAULT	1	6	Climb	MaxClimb	ZERO_C	3 000			
CNA55B	DEFAULT	1	7	Accelerate	MaxClimb	ZERO_C		1 000	250	

ACFTID	Profile_ID	Stage Length	Step Number	Step Type	Thrust Rating	Flap_ID	End Point Altitude (ft)	Rate Of Climb (ft/min)	End Point CAS (kt)	Accelerate_Percent (%)
CNA55B	DEFAULT	1	8	Climb	MaxClimb	ZERO_C	5 500			
CNA55B	DEFAULT	1	9	Climb	MaxClimb	ZERO_C	7 500			
CNA55B	DEFAULT	1	10	Climb	MaxClimb	ZERO_C	10 000			
CNA55B	FLAPS_0	1	1	Takeoff	MaxTakeoff	ZERO_D				
CNA55B	FLAPS_0	1	2	Climb	MaxTakeoff	ZERO_D	420			
CNA55B	FLAPS_0	1	3	Accelerate	MaxTakeoff	ZERO_D		1 500	156	
CNA55B	FLAPS_0	1	4	Climb	MaxTakeoff	ZERO_D	1 500			
CNA55B	FLAPS_0	1	5	Accelerate	MaxClimb	ZERO_C		1 500	181,1	
CNA55B	FLAPS_0	1	6	Climb	MaxClimb	ZERO_C	3 000			
CNA55B	FLAPS_0	1	7	Accelerate	MaxClimb	ZERO_C		1 000	250	
CNA55B	FLAPS_0	1	8	Climb	MaxClimb	ZERO_C	5 500			
CNA55B	FLAPS_0	1	9	Climb	MaxClimb	ZERO_C	7 500			
CNA55B	FLAPS_0	1	10	Climb	MaxClimb	ZERO_C	10 000			
CNA55B	FLAPS_15	1	1	Takeoff	MaxTakeoff	D_15				
CNA55B	FLAPS_15	1	2	Climb	MaxTakeoff	D_15	379			
CNA55B	FLAPS_15	1	3	Accelerate	MaxTakeoff	D_15		1 500	146,5	
CNA55B	FLAPS_15	1	4	Climb	MaxTakeoff	D_15	1 500			
CNA55B	FLAPS_15	1	5	Accelerate	MaxClimb	ZERO_C		1 500	171,5	
CNA55B	FLAPS_15	1	6	Climb	MaxClimb	ZERO_C	3 000			
CNA55B	FLAPS_15	1	7	Accelerate	MaxClimb	ZERO_C		1 000	250	

ACFTID	Profile_ID	Stage Length	Step Number	Step Type	Thrust Rating	Flap_ID	End Point Altitude (ft)	Rate Of Climb (ft/min)	End Point CAS (kt)	Accelerate_Percent (%)
CNA55B	FLAPS_15	1	8	Climb	MaxClimb	ZERO_C	5 500			
CNA55B	FLAPS_15	1	9	Climb	MaxClimb	ZERO_C	7 500			
CNA55B	FLAPS_15	1	10	Climb	MaxClimb	ZERO_C	10 000			
CNA560E	DEFAULT	1	1	Takeoff	MaxTakeoff	15				
CNA560E	DEFAULT	1	2	Climb	MaxTakeoff	15	277			
CNA560E	DEFAULT	1	3	Accelerate	MaxTakeoff	15		1 500	161,7	
CNA560E	DEFAULT	1	4	Climb	MaxTakeoff	15	1 500			
CNA560E	DEFAULT	1	5	Accelerate	MaxClimb	15		1 500	186,7	
CNA560E	DEFAULT	1	6	Climb	MaxClimb	ZERO	3 000			
CNA560E	DEFAULT	1	7	Accelerate	MaxClimb	ZERO		1 000	250	
CNA560E	DEFAULT	1	8	Climb	MaxClimb	ZERO	5 500			
CNA560E	DEFAULT	1	9	Climb	MaxClimb	ZERO	7 500			
CNA560E	DEFAULT	1	10	Climb	MaxClimb	ZERO	10 000			
CNA560U	DEFAULT	1	1	Takeoff	MaxTakeoff	15				
CNA560U	DEFAULT	1	2	Accelerate	MaxTakeoff	15		1 200	148	
CNA560U	DEFAULT	1	3	Climb	MaxTakeoff	15	1 500			
CNA560U	DEFAULT	1	4	Accelerate	MaxTakeoff	ZERO		1 500	175	
CNA560U	DEFAULT	1	5	Climb	MaxClimb	ZERO	3 000			
CNA560U	DEFAULT	1	6	Accelerate	MaxClimb	ZERO		1 500	250	
CNA560U	DEFAULT	1	7	Climb	MaxClimb	ZERO	5 500			

ACFTID	Profile_ID	Stage Length	Step Number	Step Type	Thrust Rating	Flap_ID	End Point Altitude (ft)	Rate Of Climb (ft/min)	End Point CAS (kt)	Accelerate_Percent (%)
CNA560U	DEFAULT	1	8	Climb	MaxClimb	ZERO	7 500			
CNA560U	DEFAULT	1	9	Climb	MaxClimb	ZERO	10 000			
CNA560XL	DEFAULT	1	1	Takeoff	MaxTakeoff	15				
CNA560XL	DEFAULT	1	2	Accelerate	MaxTakeoff	15		1 500	158	
CNA560XL	DEFAULT	1	3	Climb	MaxTakeoff	15	1 500			
CNA560XL	DEFAULT	1	4	Accelerate	MaxClimb	ZERO		1 500	185	
CNA560XL	DEFAULT	1	5	Climb	MaxClimb	ZERO	3 000			
CNA560XL	DEFAULT	1	6	Accelerate	MaxClimb	ZERO		1 500	250	
CNA560XL	DEFAULT	1	7	Climb	MaxClimb	ZERO	10 000			
CNA680	DEFAULT	1	1	Takeoff	MaxTakeoff	15				
CNA680	DEFAULT	1	2	Climb	MaxTakeoff	15	386			
CNA680	DEFAULT	1	3	Accelerate	MaxTakeoff	15		1 000	140,6	
CNA680	DEFAULT	1	4	Climb	MaxTakeoff	15	1 500			
CNA680	DEFAULT	1	5	Accelerate	MaxClimb	15		1 500	175	
CNA680	DEFAULT	1	6	Climb	MaxClimb	ZERO	3 000			
CNA680	DEFAULT	1	7	Accelerate	MaxClimb	ZERO		1 500	250	
CNA680	DEFAULT	1	8	Climb	MaxClimb	ZERO	5 500			
CNA680	DEFAULT	1	9	Climb	MaxClimb	ZERO	7 500			
CNA680	DEFAULT	1	10	Climb	MaxClimb	ZERO	10 000			
CNA750	DEFAULT	1	1	Takeoff	MaxTakeoff	15				

ACFTID	Profile_ID	Stage Length	Step Number	Step Type	Thrust Rating	Flap_ID	End Point Altitude (ft)	Rate Of Climb (ft/min)	End Point CAS (kt)	Accelerate_Percent (%)
CNA750	DEFAULT	1	2	Climb	MaxTakeoff	15	277			
CNA750	DEFAULT	1	3	Accelerate	MaxTakeoff	15		1 500	161,7	
CNA750	DEFAULT	1	4	Climb	MaxTakeoff	15	1 500			
CNA750	DEFAULT	1	5	Accelerate	MaxClimb	15		1 500	186,7	
CNA750	DEFAULT	1	6	Climb	MaxClimb	ZERO	3 000			
CNA750	DEFAULT	1	7	Accelerate	MaxClimb	ZERO		1 000	250	
CNA750	DEFAULT	1	8	Climb	MaxClimb	ZERO	5 500			
CNA750	DEFAULT	1	9	Climb	MaxClimb	ZERO	7 500			
CNA750	DEFAULT	1	10	Climb	MaxClimb	ZERO	10 000			
CNA750	FLAP_15	1	1	Takeoff	MaxTakeoff	15				
CNA750	FLAP_15	1	2	Climb	MaxTakeoff	15	277			
CNA750	FLAP_15	1	3	Accelerate	MaxTakeoff	15		1 500	161,7	
CNA750	FLAP_15	1	4	Climb	MaxTakeoff	15	1 500			
CNA750	FLAP_15	1	5	Accelerate	MaxClimb	15		1 500	186,7	
CNA750	FLAP_15	1	6	Climb	MaxClimb	ZERO	3 000			
CNA750	FLAP_15	1	7	Accelerate	MaxClimb	ZERO		1 000	250	
CNA750	FLAP_15	1	8	Climb	MaxClimb	ZERO	5 500			
CNA750	FLAP_15	1	9	Climb	MaxClimb	ZERO	7 500			
CNA750	FLAP_15	1	10	Climb	MaxClimb	ZERO	10 000			
CNA750	FLAP_5	1	1	Takeoff	MaxTakeoff	5				

ACFTID	Profile_ID	Stage Length	Step Number	Step Type	Thrust Rating	Flap_ID	End Point Altitude (ft)	Rate Of Climb (ft/min)	End Point CAS (kt)	Accelerate_Percent (%)
CNA750	FLAP_5	1	2	Climb	MaxTakeoff	5	285			
CNA750	FLAP_5	1	3	Accelerate	MaxTakeoff	5		1 500	168,9	
CNA750	FLAP_5	1	4	Climb	MaxTakeoff	5	1 500			
CNA750	FLAP_5	1	5	Accelerate	MaxClimb	5		1 500	193,9	
CNA750	FLAP_5	1	6	Climb	MaxClimb	ZERO	3 000			
CNA750	FLAP_5	1	7	Accelerate	MaxClimb	ZERO		1 000	250	
CNA750	FLAP_5	1	8	Climb	MaxClimb	ZERO	5 500			
CNA750	FLAP_5	1	9	Climb	MaxClimb	ZERO	7 500			
CNA750	FLAP_5	1	10	Climb	MaxClimb	ZERO	10 000			
CRJ9-ER	DEFAULT	1	1	Takeoff	MaxTakeoff	D-8				
CRJ9-ER	DEFAULT	1	2	Climb	MaxTakeoff	D-8	595			
CRJ9-ER	DEFAULT	1	3	Climb	MaxTakeoff	U-8	1 000			
CRJ9-ER	DEFAULT	1	4	Accelerate	MaxClimb	0-204		500	204	
CRJ9-ER	DEFAULT	1	5	Climb	MaxClimb	ZERO	3 000			
CRJ9-ER	DEFAULT	1	6	Accelerate	MaxClimb	0-250		500	250	
CRJ9-ER	DEFAULT	1	7	Climb	MaxClimb	ZERO	10 000			
CRJ9-ER	DEFAULT	2	1	Takeoff	MaxTakeoff	D-8				
CRJ9-ER	DEFAULT	2	2	Climb	MaxTakeoff	D-8	555			
CRJ9-ER	DEFAULT	2	3	Climb	MaxTakeoff	U-8	1 000			
CRJ9-ER	DEFAULT	2	4	Accelerate	MaxClimb	0-204		500	204	

ACFTID	Profile_ID	Stage Length	Step Number	Step Type	Thrust Rating	Flap_ID	End Point Altitude (ft)	Rate Of Climb (ft/min)	End Point CAS (kt)	Accelerate_Percent (%)
CRJ9-ER	DEFAULT	2	5	Climb	MaxClimb	ZERO	3 000			
CRJ9-ER	DEFAULT	2	6	Accelerate	MaxClimb	0-250		500	250	
CRJ9-ER	DEFAULT	2	7	Climb	MaxClimb	ZERO	10 000			
CRJ9-ER	DEFAULT	3	1	Takeoff	MaxTakeoff	D-8				
CRJ9-ER	DEFAULT	3	2	Climb	MaxTakeoff	D-8	525			
CRJ9-ER	DEFAULT	3	3	Climb	MaxTakeoff	U-8	1 000			
CRJ9-ER	DEFAULT	3	4	Accelerate	MaxClimb	0-204		500	204	
CRJ9-ER	DEFAULT	3	5	Climb	MaxClimb	ZERO	3 000			
CRJ9-ER	DEFAULT	3	6	Accelerate	MaxClimb	0-250		500	250	
CRJ9-ER	DEFAULT	3	7	Climb	MaxClimb	ZERO	10 000			
CRJ9-ER	DEFAULT	4	1	Takeoff	MaxTakeoff	D-8				
CRJ9-ER	DEFAULT	4	2	Climb	MaxTakeoff	D-8	485			
CRJ9-ER	DEFAULT	4	3	Climb	MaxTakeoff	U-8	1 000			
CRJ9-ER	DEFAULT	4	4	Accelerate	MaxClimb	0-204		500	204	
CRJ9-ER	DEFAULT	4	5	Climb	MaxClimb	ZERO	3 000			
CRJ9-ER	DEFAULT	4	6	Accelerate	MaxClimb	0-250		500	250	
CRJ9-ER	DEFAULT	4	7	Climb	MaxClimb	ZERO	10 000			
CRJ9-ER	DEFAULT	5	1	Takeoff	MaxTakeoff	D-8				
CRJ9-ER	DEFAULT	5	2	Climb	MaxTakeoff	D-8	465			
CRJ9-ER	DEFAULT	5	3	Climb	MaxTakeoff	U-8	1 000			

ACFTID	Profile_ID	Stage Length	Step Number	Step Type	Thrust Rating	Flap_ID	End Point Altitude (ft)	Rate Of Climb (ft/min)	End Point CAS (kt)	Accelerate_Percent (%)
CRJ9-ER	DEFAULT	5	4	Accelerate	MaxClimb	0-204		500	204	
CRJ9-ER	DEFAULT	5	5	Climb	MaxClimb	0-204	3 000			
CRJ9-ER	DEFAULT	5	6	Accelerate	MaxClimb	0-250		500	250	
CRJ9-ER	DEFAULT	5	7	Climb	MaxClimb	ZERO	10 000			
CRJ9-ER	ICAO_A	1	1	Takeoff	MaxTakeoff	D-8				
CRJ9-ER	ICAO_A	1	2	Climb	MaxTakeoff	D-8	595			
CRJ9-ER	ICAO_A	1	3	Climb	MaxTakeoff	U-8	1 500			
CRJ9-ER	ICAO_A	1	4	Climb	MaxClimb	U-8	3 000			
CRJ9-ER	ICAO_A	1	5	Accelerate	MaxClimb	0-250		500	250	
CRJ9-ER	ICAO_A	1	6	Climb	MaxClimb	ZERO	10 000			
CRJ9-ER	ICAO_A	2	1	Takeoff	MaxTakeoff	D-8				
CRJ9-ER	ICAO_A	2	2	Climb	MaxTakeoff	D-8	555			
CRJ9-ER	ICAO_A	2	3	Climb	MaxTakeoff	U-8	1 500			
CRJ9-ER	ICAO_A	2	4	Climb	MaxClimb	U-8	3 000			
CRJ9-ER	ICAO_A	2	5	Accelerate	MaxClimb	0-250		500	250	
CRJ9-ER	ICAO_A	2	6	Climb	MaxClimb	ZERO	10 000			
CRJ9-ER	ICAO_A	3	1	Takeoff	MaxTakeoff	D-8				
CRJ9-ER	ICAO_A	3	2	Climb	MaxTakeoff	D-8	525			
CRJ9-ER	ICAO_A	3	3	Climb	MaxTakeoff	U-8	1 500			
CRJ9-ER	ICAO_A	3	4	Climb	MaxClimb	U-8	3 000			

ACFTID	Profile_ID	Stage Length	Step Number	Step Type	Thrust Rating	Flap_ID	End Point Altitude (ft)	Rate Of Climb (ft/min)	End Point CAS (kt)	Accelerate_Percent (%)
CRJ9-ER	ICAO_A	3	5	Accelerate	MaxClimb	0-250		500	250	
CRJ9-ER	ICAO_A	3	6	Climb	MaxClimb	ZERO	10 000			
CRJ9-ER	ICAO_A	4	1	Takeoff	MaxTakeoff	D-8				
CRJ9-ER	ICAO_A	4	2	Climb	MaxTakeoff	D-8	485			
CRJ9-ER	ICAO_A	4	3	Climb	MaxTakeoff	U-8	1 500			
CRJ9-ER	ICAO_A	4	4	Climb	MaxClimb	U-8	3 000			
CRJ9-ER	ICAO_A	4	5	Accelerate	MaxClimb	0-250		500	250	
CRJ9-ER	ICAO_A	4	6	Climb	MaxClimb	ZERO	10 000			
CRJ9-ER	ICAO_A	5	1	Takeoff	MaxTakeoff	D-8				
CRJ9-ER	ICAO_A	5	2	Climb	MaxTakeoff	D-8	465			
CRJ9-ER	ICAO_A	5	3	Climb	MaxTakeoff	U-8	1 500			
CRJ9-ER	ICAO_A	5	4	Climb	MaxClimb	U-8	3 000			
CRJ9-ER	ICAO_A	5	5	Accelerate	MaxClimb	0-250		500	250	
CRJ9-ER	ICAO_A	5	6	Climb	MaxClimb	ZERO	10 000			
CRJ9-ER	ICAO_B	1	1	Takeoff	MaxTakeoff	D-8				
CRJ9-ER	ICAO_B	1	2	Climb	MaxTakeoff	D-8	595			
CRJ9-ER	ICAO_B	1	3	Climb	MaxTakeoff	U-8	1 000			
CRJ9-ER	ICAO_B	1	4	Accelerate	MaxTakeoff	0-204		500	204	
CRJ9-ER	ICAO_B	1	5	Climb	MaxClimb	ZERO	3 000			
CRJ9-ER	ICAO_B	1	6	Accelerate	MaxClimb	0-250		500	250	

ACFTID	Profile_ID	Stage Length	Step Number	Step Type	Thrust Rating	Flap_ID	End Point Altitude (ft)	Rate Of Climb (ft/min)	End Point CAS (kt)	Accelerate_Percent (%)
CRJ9-ER	ICAO_B	1	7	Climb	MaxClimb	ZERO	10 000			
CRJ9-ER	ICAO_B	2	1	Takeoff	MaxTakeoff	D-8				
CRJ9-ER	ICAO_B	2	2	Climb	MaxTakeoff	D-8	555			
CRJ9-ER	ICAO_B	2	3	Climb	MaxTakeoff	U-8	1 000			
CRJ9-ER	ICAO_B	2	4	Accelerate	MaxTakeoff	0-204		500	204	
CRJ9-ER	ICAO_B	2	5	Climb	MaxClimb	ZERO	3 000			
CRJ9-ER	ICAO_B	2	6	Accelerate	MaxClimb	0-250		500	250	
CRJ9-ER	ICAO_B	2	7	Climb	MaxClimb	ZERO	10 000			
CRJ9-ER	ICAO_B	3	1	Takeoff	MaxTakeoff	D-8				
CRJ9-ER	ICAO_B	3	2	Climb	MaxTakeoff	D-8	525			
CRJ9-ER	ICAO_B	3	3	Climb	MaxTakeoff	U-8	1 000			
CRJ9-ER	ICAO_B	3	4	Accelerate	MaxTakeoff	0-204		500	204	
CRJ9-ER	ICAO_B	3	5	Climb	MaxClimb	ZERO	3 000			
CRJ9-ER	ICAO_B	3	6	Accelerate	MaxClimb	0-250		500	250	
CRJ9-ER	ICAO_B	3	7	Climb	MaxClimb	ZERO	10 000			
CRJ9-ER	ICAO_B	4	1	Takeoff	MaxTakeoff	D-8				
CRJ9-ER	ICAO_B	4	2	Climb	MaxTakeoff	D-8	485			
CRJ9-ER	ICAO_B	4	3	Climb	MaxTakeoff	U-8	1 000			
CRJ9-ER	ICAO_B	4	4	Accelerate	MaxTakeoff	0-204		500	204	
CRJ9-ER	ICAO_B	4	5	Climb	MaxClimb	ZERO	3 000			

ACFTID	Profile_ID	Stage Length	Step Number	Step Type	Thrust Rating	Flap_ID	End Point Altitude (ft)	Rate Of Climb (ft/min)	End Point CAS (kt)	Accelerate_Percent (%)
CRJ9-ER	ICAO_B	4	6	Accelerate	MaxClimb	0-250		500	250	
CRJ9-ER	ICAO_B	4	7	Climb	MaxClimb	ZERO	10 000			
CRJ9-ER	ICAO_B	5	1	Takeoff	MaxTakeoff	D-8				
CRJ9-ER	ICAO_B	5	2	Climb	MaxTakeoff	D-8	465			
CRJ9-ER	ICAO_B	5	3	Climb	MaxTakeoff	U-8	1 000			
CRJ9-ER	ICAO_B	5	4	Accelerate	MaxTakeoff	0-204		500	204	
CRJ9-ER	ICAO_B	5	5	Climb	MaxClimb	ZERO	3 000			
CRJ9-ER	ICAO_B	5	6	Accelerate	MaxClimb	0-250		500	250	
CRJ9-ER	ICAO_B	5	7	Climb	MaxClimb	ZERO	10 000			
CRJ9-LR	DEFAULT	1	1	Takeoff	MaxTakeoff	D-8				
CRJ9-LR	DEFAULT	1	2	Climb	MaxTakeoff	D-8	615			
CRJ9-LR	DEFAULT	1	3	Climb	MaxTakeoff	U-8	1 000			
CRJ9-LR	DEFAULT	1	4	Accelerate	MaxClimb	0-204		500	204	
CRJ9-LR	DEFAULT	1	5	Climb	MaxClimb	ZERO	3 000			
CRJ9-LR	DEFAULT	1	6	Accelerate	MaxClimb	0-250		500	250	
CRJ9-LR	DEFAULT	1	7	Climb	MaxClimb	ZERO	10 000			
CRJ9-LR	DEFAULT	2	1	Takeoff	MaxTakeoff	D-8				
CRJ9-LR	DEFAULT	2	2	Climb	MaxTakeoff	D-8	575			
CRJ9-LR	DEFAULT	2	3	Climb	MaxTakeoff	U-8	1 000			
CRJ9-LR	DEFAULT	2	4	Accelerate	MaxClimb	0-204		500	204	

ACFTID	Profile_ID	Stage Length	Step Number	Step Type	Thrust Rating	Flap_ID	End Point Altitude (ft)	Rate Of Climb (ft/min)	End Point CAS (kt)	Accelerate_Percent (%)
CRJ9-LR	DEFAULT	2	5	Climb	MaxClimb	ZERO	3 000			
CRJ9-LR	DEFAULT	2	6	Accelerate	MaxClimb	0-250		500	250	
CRJ9-LR	DEFAULT	2	7	Climb	MaxClimb	ZERO	10 000			
CRJ9-LR	DEFAULT	3	1	Takeoff	MaxTakeoff	D-8				
CRJ9-LR	DEFAULT	3	2	Climb	MaxTakeoff	D-8	545			
CRJ9-LR	DEFAULT	3	3	Climb	MaxTakeoff	U-8	1 000			
CRJ9-LR	DEFAULT	3	4	Accelerate	MaxClimb	0-204		500	204	
CRJ9-LR	DEFAULT	3	5	Climb	MaxClimb	0-204	3 000			
CRJ9-LR	DEFAULT	3	6	Accelerate	MaxClimb	0-250		500	250	
CRJ9-LR	DEFAULT	3	7	Climb	MaxClimb	ZERO	10 000			
CRJ9-LR	DEFAULT	4	1	Takeoff	MaxTakeoff	D-8				
CRJ9-LR	DEFAULT	4	2	Climb	MaxTakeoff	D-8	505			
CRJ9-LR	DEFAULT	4	3	Climb	MaxTakeoff	U-8	1 000			
CRJ9-LR	DEFAULT	4	4	Accelerate	MaxClimb	0-204		500	204	
CRJ9-LR	DEFAULT	4	5	Climb	MaxClimb	ZERO	3 000			
CRJ9-LR	DEFAULT	4	6	Accelerate	MaxClimb	0-250		500	250	
CRJ9-LR	DEFAULT	4	7	Climb	MaxClimb	0-250	10 000			
CRJ9-LR	DEFAULT	5	1	Takeoff	MaxTakeoff	D-8				
CRJ9-LR	DEFAULT	5	2	Climb	MaxTakeoff	D-8	455			
CRJ9-LR	DEFAULT	5	3	Climb	MaxTakeoff	U-8	1 000			

ACFTID	Profile_ID	Stage Length	Step Number	Step Type	Thrust Rating	Flap_ID	End Point Altitude (ft)	Rate Of Climb (ft/min)	End Point CAS (kt)	Accelerate_Percent (%)
CRJ9-LR	DEFAULT	5	4	Accelerate	MaxClimb	0-204		500	204	
CRJ9-LR	DEFAULT	5	5	Climb	MaxClimb	ZERO	3 000			
CRJ9-LR	DEFAULT	5	6	Accelerate	MaxClimb	0-250		500	250	
CRJ9-LR	DEFAULT	5	7	Climb	MaxClimb	ZERO	10 000			
CRJ9-LR	ICAO_A	1	1	Takeoff	MaxTakeoff	D-8				
CRJ9-LR	ICAO_A	1	2	Climb	MaxTakeoff	D-8	615			
CRJ9-LR	ICAO_A	1	3	Climb	MaxTakeoff	U-8	1 500			
CRJ9-LR	ICAO_A	1	4	Climb	MaxClimb	U-8	3 000			
CRJ9-LR	ICAO_A	1	5	Accelerate	MaxClimb	0-250		500	250	
CRJ9-LR	ICAO_A	1	6	Climb	MaxClimb	ZERO	10 000			
CRJ9-LR	ICAO_A	2	1	Takeoff	MaxTakeoff	D-8				
CRJ9-LR	ICAO_A	2	2	Climb	MaxTakeoff	D-8	575			
CRJ9-LR	ICAO_A	2	3	Climb	MaxTakeoff	U-8	1 500			
CRJ9-LR	ICAO_A	2	4	Climb	MaxClimb	U-8	3 000			
CRJ9-LR	ICAO_A	2	5	Accelerate	MaxClimb	U-8		500	250	
CRJ9-LR	ICAO_A	2	6	Climb	MaxClimb	ZERO	10 000			
CRJ9-LR	ICAO_A	3	1	Takeoff	MaxTakeoff	D-8				
CRJ9-LR	ICAO_A	3	2	Climb	MaxTakeoff	D-8	545			
CRJ9-LR	ICAO_A	3	3	Climb	MaxTakeoff	U-8	1 500			
CRJ9-LR	ICAO_A	3	4	Climb	MaxClimb	U-8	3 000			

ACFTID	Profile_ID	Stage Length	Step Number	Step Type	Thrust Rating	Flap_ID	End Point Altitude (ft)	Rate Of Climb (ft/min)	End Point CAS (kt)	Accelerate_Percent (%)
CRJ9-LR	ICAO_A	3	5	Accelerate	MaxClimb	U-8		500	250	
CRJ9-LR	ICAO_A	3	6	Climb	MaxClimb	ZERO	10 000			
CRJ9-LR	ICAO_A	4	1	Takeoff	MaxTakeoff	D-8				
CRJ9-LR	ICAO_A	4	2	Climb	MaxTakeoff	D-8	505			
CRJ9-LR	ICAO_A	4	3	Climb	MaxTakeoff	U-8	1 500			
CRJ9-LR	ICAO_A	4	4	Climb	MaxClimb	U-8	3 000			
CRJ9-LR	ICAO_A	4	5	Accelerate	MaxClimb	U-8		500	250	
CRJ9-LR	ICAO_A	4	6	Climb	MaxClimb	ZERO	10 000			
CRJ9-LR	ICAO_A	5	1	Takeoff	MaxTakeoff	D-8				
CRJ9-LR	ICAO_A	5	2	Climb	MaxTakeoff	D-8	455			
CRJ9-LR	ICAO_A	5	3	Climb	MaxTakeoff	U-8	1 500			
CRJ9-LR	ICAO_A	5	4	Climb	MaxClimb	U-8	3 000			
CRJ9-LR	ICAO_A	5	5	Accelerate	MaxClimb	0-250		500	250	
CRJ9-LR	ICAO_A	5	6	Climb	MaxClimb	ZERO	10 000			
CRJ9-LR	ICAO_B	1	1	Takeoff	MaxTakeoff	D-8				
CRJ9-LR	ICAO_B	1	2	Climb	MaxTakeoff	D-8	615			
CRJ9-LR	ICAO_B	1	3	Climb	MaxTakeoff	U-8	1 000			
CRJ9-LR	ICAO_B	1	4	Accelerate	MaxTakeoff	0-204		500	204	
CRJ9-LR	ICAO_B	1	5	Climb	MaxClimb	ZERO	3 000			
CRJ9-LR	ICAO_B	1	6	Accelerate	MaxClimb	0-250		500	250	

ACFTID	Profile_ID	Stage Length	Step Number	Step Type	Thrust Rating	Flap_ID	End Point Altitude (ft)	Rate Of Climb (ft/min)	End Point CAS (kt)	Accelerate_Percent (%)
CRJ9-LR	ICAO_B	1	7	Climb	MaxClimb	ZERO	10 000			
CRJ9-LR	ICAO_B	2	1	Takeoff	MaxTakeoff	D-8				
CRJ9-LR	ICAO_B	2	2	Climb	MaxTakeoff	D-8	575			
CRJ9-LR	ICAO_B	2	3	Climb	MaxTakeoff	U-8	1 000			
CRJ9-LR	ICAO_B	2	4	Accelerate	MaxTakeoff	0-204		500	204	
CRJ9-LR	ICAO_B	2	5	Climb	MaxClimb	ZERO	3 000			
CRJ9-LR	ICAO_B	2	6	Accelerate	MaxClimb	0-250		500	250	
CRJ9-LR	ICAO_B	2	7	Climb	MaxClimb	ZERO	10 000			
CRJ9-LR	ICAO_B	3	1	Takeoff	MaxTakeoff	D-8				
CRJ9-LR	ICAO_B	3	2	Climb	MaxTakeoff	D-8	545			
CRJ9-LR	ICAO_B	3	3	Climb	MaxTakeoff	U-8	1 000			
CRJ9-LR	ICAO_B	3	4	Accelerate	MaxTakeoff	0-204		500	204	
CRJ9-LR	ICAO_B	3	5	Climb	MaxClimb	ZERO	3 000			
CRJ9-LR	ICAO_B	3	6	Accelerate	MaxClimb	0-250		500	250	
CRJ9-LR	ICAO_B	3	7	Climb	MaxClimb	ZERO	10 000			
CRJ9-LR	ICAO_B	4	1	Takeoff	MaxTakeoff	D-8				
CRJ9-LR	ICAO_B	4	2	Climb	MaxTakeoff	D-8	505			
CRJ9-LR	ICAO_B	4	3	Climb	MaxTakeoff	U-8	1 000			
CRJ9-LR	ICAO_B	4	4	Accelerate	MaxTakeoff	0-204		500	204	
CRJ9-LR	ICAO_B	4	5	Climb	MaxClimb	ZERO	3 000			

ACFTID	Profile_ID	Stage Length	Step Number	Step Type	Thrust Rating	Flap_ID	End Point Altitude (ft)	Rate Of Climb (ft/min)	End Point CAS (kt)	Accelerate_Percent (%)
CRJ9-LR	ICAO_B	4	6	Accelerate	MaxClimb	0-250		500	250	
CRJ9-LR	ICAO_B	4	7	Climb	MaxClimb	ZERO	10 000			
CRJ9-LR	ICAO_B	5	1	Takeoff	MaxTakeoff	D-8				
CRJ9-LR	ICAO_B	5	2	Climb	MaxTakeoff	D-8	455			
CRJ9-LR	ICAO_B	5	3	Climb	MaxTakeoff	U-8	1 000			
CRJ9-LR	ICAO_B	5	4	Accelerate	MaxTakeoff	0-204		500	204	
CRJ9-LR	ICAO_B	5	5	Climb	MaxClimb	ZERO	3 000			
CRJ9-LR	ICAO_B	5	6	Accelerate	MaxClimb	0-250		500	250	
CRJ9-LR	ICAO_B	5	7	Climb	MaxClimb	ZERO	10 000			
CVR580	DEFAULT	1	1	Takeoff	MaxTakeoff	10				
CVR580	DEFAULT	1	2	Climb	MaxTakeoff	10	1 000			
CVR580	DEFAULT	1	3	Accelerate	MaxTakeoff	10		1 907	130	
CVR580	DEFAULT	1	4	Accelerate	MaxClimb	INTR		1 430	150	
CVR580	DEFAULT	1	5	Climb	MaxClimb	ZERO	3 000			
CVR580	DEFAULT	1	6	Climb	MaxClimb	ZERO	5 500			
CVR580	DEFAULT	1	7	Climb	MaxClimb	ZERO	7 500			
CVR580	DEFAULT	1	8	Climb	MaxClimb	ZERO	10 000			
CVR580	DEFAULT	2	1	Takeoff	MaxTakeoff	10				
CVR580	DEFAULT	2	2	Climb	MaxTakeoff	10	1 000			
CVR580	DEFAULT	2	3	Accelerate	MaxTakeoff	10		1 557	136	

ACFTID	Profile_ID	Stage Length	Step Number	Step Type	Thrust Rating	Flap_ID	End Point Altitude (ft)	Rate Of Climb (ft/min)	End Point CAS (kt)	Accelerate_Percent (%)
CVR580	DEFAULT	2	4	Accelerate	MaxClimb	INTR		1 168	156	
CVR580	DEFAULT	2	5	Climb	MaxClimb	ZERO	3 000			
CVR580	DEFAULT	2	6	Climb	MaxClimb	ZERO	5 500			
CVR580	DEFAULT	2	7	Climb	MaxClimb	ZERO	7 500			
CVR580	DEFAULT	2	8	Climb	MaxClimb	ZERO	10 000			
CVR580	DEFAULT	3	1	Takeoff	MaxTakeoff	10				
CVR580	DEFAULT	3	2	Climb	MaxTakeoff	10	1 000			
CVR580	DEFAULT	3	3	Accelerate	MaxTakeoff	10		1 321	140	
CVR580	DEFAULT	3	4	Accelerate	MaxClimb	INTR		991	160	
CVR580	DEFAULT	3	5	Climb	MaxClimb	ZERO	3 000			
CVR580	DEFAULT	3	6	Climb	MaxClimb	ZERO	5 500			
CVR580	DEFAULT	3	7	Climb	MaxClimb	ZERO	7 500			
CVR580	DEFAULT	3	8	Climb	MaxClimb	ZERO	10 000			
DC1010	DEFAULT	1	1	Takeoff	MaxTakeoff	10				
DC1010	DEFAULT	1	2	Climb	MaxTakeoff	10	1 000			
DC1010	DEFAULT	1	3	Accelerate	MaxTakeoff	10		1 904	159	
DC1010	DEFAULT	1	4	Accelerate	MaxTakeoff	5		1 428	174	
DC1010	DEFAULT	1	5	Accelerate	MaxClimb	INT		1 000	189	
DC1010	DEFAULT	1	6	Climb	MaxClimb	ZERO	3 000			
DC1010	DEFAULT	1	7	Accelerate	MaxClimb	ZERO		1 000	250	

ACFTID	Profile_ID	Stage Length	Step Number	Step Type	Thrust Rating	Flap_ID	End Point Altitude (ft)	Rate Of Climb (ft/min)	End Point CAS (kt)	Accelerate_Percent (%)
DC1010	DEFAULT	1	8	Climb	MaxClimb	ZERO	5 500			
DC1010	DEFAULT	1	9	Climb	MaxClimb	ZERO	7 500			
DC1010	DEFAULT	1	10	Climb	MaxClimb	ZERO	10 000			
DC1010	DEFAULT	2	1	Takeoff	MaxTakeoff	10				
DC1010	DEFAULT	2	2	Climb	MaxTakeoff	10	1 000			
DC1010	DEFAULT	2	3	Accelerate	MaxTakeoff	10		1 799	163	
DC1010	DEFAULT	2	4	Accelerate	MaxTakeoff	5		1 350	178	
DC1010	DEFAULT	2	5	Accelerate	MaxClimb	INT		1 000	193	
DC1010	DEFAULT	2	6	Climb	MaxClimb	ZERO	3 000			
DC1010	DEFAULT	2	7	Accelerate	MaxClimb	ZERO		1 000	250	
DC1010	DEFAULT	2	8	Climb	MaxClimb	ZERO	5 500			
DC1010	DEFAULT	2	9	Climb	MaxClimb	ZERO	7 500			
DC1010	DEFAULT	2	10	Climb	MaxClimb	ZERO	10 000			
DC1010	DEFAULT	3	1	Takeoff	MaxTakeoff	10				
DC1010	DEFAULT	3	2	Climb	MaxTakeoff	10	1 000			
DC1010	DEFAULT	3	3	Accelerate	MaxTakeoff	10		1 670	167	
DC1010	DEFAULT	3	4	Accelerate	MaxTakeoff	5		1 253	182	
DC1010	DEFAULT	3	5	Accelerate	MaxClimb	INT		1 000	197	
DC1010	DEFAULT	3	6	Climb	MaxClimb	ZERO	3 000			
DC1010	DEFAULT	3	7	Accelerate	MaxClimb	ZERO		1 000	250	

ACFTID	Profile_ID	Stage Length	Step Number	Step Type	Thrust Rating	Flap_ID	End Point Altitude (ft)	Rate Of Climb (ft/min)	End Point CAS (kt)	Accelerate_Percent (%)
DC1010	DEFAULT	3	8	Climb	MaxClimb	ZERO	5 500			
DC1010	DEFAULT	3	9	Climb	MaxClimb	ZERO	7 500			
DC1010	DEFAULT	3	10	Climb	MaxClimb	ZERO	10 000			
DC1010	DEFAULT	4	1	Takeoff	MaxTakeoff	10				
DC1010	DEFAULT	4	2	Climb	MaxTakeoff	10	1 000			
DC1010	DEFAULT	4	3	Accelerate	MaxTakeoff	10		1 494	174	
DC1010	DEFAULT	4	4	Accelerate	MaxTakeoff	5		1 121	189	
DC1010	DEFAULT	4	5	Accelerate	MaxClimb	INT		1 000	204	
DC1010	DEFAULT	4	6	Climb	MaxClimb	ZERO	3 000			
DC1010	DEFAULT	4	7	Accelerate	MaxClimb	ZERO		1 000	250	
DC1010	DEFAULT	4	8	Climb	MaxClimb	ZERO	5 500			
DC1010	DEFAULT	4	9	Climb	MaxClimb	ZERO	7 500			
DC1010	DEFAULT	4	10	Climb	MaxClimb	ZERO	10 000			
DC1010	DEFAULT	5	1	Takeoff	MaxTakeoff	10				
DC1010	DEFAULT	5	2	Climb	MaxTakeoff	10	1 000			
DC1010	DEFAULT	5	3	Accelerate	MaxTakeoff	10		1 335	180	
DC1010	DEFAULT	5	4	Accelerate	MaxTakeoff	5		1 002	195	
DC1010	DEFAULT	5	5	Accelerate	MaxClimb	INT		1 000	210	
DC1010	DEFAULT	5	6	Climb	MaxClimb	ZERO	3 000			
DC1010	DEFAULT	5	7	Accelerate	MaxClimb	ZERO		1 000	250	

ACFTID	Profile_ID	Stage Length	Step Number	Step Type	Thrust Rating	Flap_ID	End Point Altitude (ft)	Rate Of Climb (ft/min)	End Point CAS (kt)	Accelerate_Percent (%)
DC1010	DEFAULT	5	8	Climb	MaxClimb	ZERO	5 500			
DC1010	DEFAULT	5	9	Climb	MaxClimb	ZERO	7 500			
DC1010	DEFAULT	5	10	Climb	MaxClimb	ZERO	10 000			
DC1010	DEFAULT	6	1	Takeoff	MaxTakeoff	10				
DC1010	DEFAULT	6	2	Climb	MaxTakeoff	10	1 000			
DC1010	DEFAULT	6	3	Accelerate	MaxTakeoff	10		1 191	186	
DC1010	DEFAULT	6	4	Accelerate	MaxTakeoff	5		894	201	
DC1010	DEFAULT	6	5	Accelerate	MaxClimb	INT		800	216	
DC1010	DEFAULT	6	6	Climb	MaxClimb	ZERO	3 000			
DC1010	DEFAULT	6	7	Accelerate	MaxClimb	ZERO		800	250	
DC1010	DEFAULT	6	8	Climb	MaxClimb	ZERO	5 500			
DC1010	DEFAULT	6	9	Climb	MaxClimb	ZERO	7 500			
DC1010	DEFAULT	6	10	Climb	MaxClimb	ZERO	10 000			
DC1040	DEFAULT	1	1	Takeoff	MaxTakeoff	15				
DC1040	DEFAULT	1	2	Climb	MaxTakeoff	15	1 000			
DC1040	DEFAULT	1	3	Accelerate	MaxTakeoff	15		2 255	175	
DC1040	DEFAULT	1	4	Accelerate	MaxTakeoff	5		1 692	190	
DC1040	DEFAULT	1	5	Accelerate	MaxClimb	INT		1 000	205	
DC1040	DEFAULT	1	6	Climb	MaxClimb	ZERO	3 000			
DC1040	DEFAULT	1	7	Accelerate	MaxClimb	ZERO		1 000	250	

ACFTID	Profile_ID	Stage Length	Step Number	Step Type	Thrust Rating	Flap_ID	End Point Altitude (ft)	Rate Of Climb (ft/min)	End Point CAS (kt)	Accelerate_Percent (%)
DC1040	DEFAULT	1	8	Climb	MaxClimb	ZERO	5 500			
DC1040	DEFAULT	1	9	Climb	MaxClimb	ZERO	7 500			
DC1040	DEFAULT	1	10	Climb	MaxClimb	ZERO	10 000			
DC1040	DEFAULT	2	1	Takeoff	MaxTakeoff	15				
DC1040	DEFAULT	2	2	Climb	MaxTakeoff	15	1 000			
DC1040	DEFAULT	2	3	Accelerate	MaxTakeoff	15		2 146	178	
DC1040	DEFAULT	2	4	Accelerate	MaxTakeoff	5		1 610	193	
DC1040	DEFAULT	2	5	Accelerate	MaxClimb	INT		1 000	208	
DC1040	DEFAULT	2	6	Climb	MaxClimb	ZERO	3 000			
DC1040	DEFAULT	2	7	Accelerate	MaxClimb	ZERO		1 000	250	
DC1040	DEFAULT	2	8	Climb	MaxClimb	ZERO	5 500			
DC1040	DEFAULT	2	9	Climb	MaxClimb	ZERO	7 500			
DC1040	DEFAULT	2	10	Climb	MaxClimb	ZERO	10 000			
DC1040	DEFAULT	3	1	Takeoff	MaxTakeoff	15				
DC1040	DEFAULT	3	2	Climb	MaxTakeoff	15	1 000			
DC1040	DEFAULT	3	3	Accelerate	MaxTakeoff	15		2 050	181	
DC1040	DEFAULT	3	4	Accelerate	MaxTakeoff	5		1 538	196	
DC1040	DEFAULT	3	5	Accelerate	MaxClimb	INT		1 000	211	
DC1040	DEFAULT	3	6	Climb	MaxClimb	ZERO	3 000			
DC1040	DEFAULT	3	7	Accelerate	MaxClimb	ZERO		1 000	250	

ACFTID	Profile_ID	Stage Length	Step Number	Step Type	Thrust Rating	Flap_ID	End Point Altitude (ft)	Rate Of Climb (ft/min)	End Point CAS (kt)	Accelerate_Percent (%)
DC1040	DEFAULT	3	8	Climb	MaxClimb	ZERO	5 500			
DC1040	DEFAULT	3	9	Climb	MaxClimb	ZERO	7 500			
DC1040	DEFAULT	3	10	Climb	MaxClimb	ZERO	10 000			
DC1040	DEFAULT	4	1	Takeoff	MaxTakeoff	15				
DC1040	DEFAULT	4	2	Climb	MaxTakeoff	15	1 000			
DC1040	DEFAULT	4	3	Accelerate	MaxTakeoff	15		1 859	187	
DC1040	DEFAULT	4	4	Accelerate	MaxTakeoff	5		1 395	202	
DC1040	DEFAULT	4	5	Accelerate	MaxClimb	INT		1 000	217	
DC1040	DEFAULT	4	6	Climb	MaxClimb	ZERO	3 000			
DC1040	DEFAULT	4	7	Accelerate	MaxClimb	ZERO		1 000	250	
DC1040	DEFAULT	4	8	Climb	MaxClimb	ZERO	5 500			
DC1040	DEFAULT	4	9	Climb	MaxClimb	ZERO	7 500			
DC1040	DEFAULT	4	10	Climb	MaxClimb	ZERO	10 000			
DC1040	DEFAULT	5	1	Takeoff	MaxTakeoff	15				
DC1040	DEFAULT	5	2	Climb	MaxTakeoff	15	1 000			
DC1040	DEFAULT	5	3	Accelerate	MaxTakeoff	15		1 639	195	
DC1040	DEFAULT	5	4	Accelerate	MaxTakeoff	5		1 229	210	
DC1040	DEFAULT	5	5	Accelerate	MaxClimb	INT		1 000	225	
DC1040	DEFAULT	5	6	Climb	MaxClimb	ZERO	3 000			
DC1040	DEFAULT	5	7	Accelerate	MaxClimb	ZERO		1 000	250	

ACFTID	Profile_ID	Stage Length	Step Number	Step Type	Thrust Rating	Flap_ID	End Point Altitude (ft)	Rate Of Climb (ft/min)	End Point CAS (kt)	Accelerate_Percent (%)
DC1040	DEFAULT	5	8	Climb	MaxClimb	ZERO	5 500			
DC1040	DEFAULT	5	9	Climb	MaxClimb	ZERO	7 500			
DC1040	DEFAULT	5	10	Climb	MaxClimb	ZERO	10 000			
DC1040	DEFAULT	6	1	Takeoff	MaxTakeoff	15				
DC1040	DEFAULT	6	2	Climb	MaxTakeoff	15	1 000			
DC1040	DEFAULT	6	3	Accelerate	MaxTakeoff	15		1 436	203	
DC1040	DEFAULT	6	4	Accelerate	MaxTakeoff	5		1 077	218	
DC1040	DEFAULT	6	5	Accelerate	MaxClimb	INT		1 000	233	
DC1040	DEFAULT	6	6	Climb	MaxClimb	ZERO	3 000			
DC1040	DEFAULT	6	7	Accelerate	MaxClimb	ZERO		1 000	250	
DC1040	DEFAULT	6	8	Climb	MaxClimb	ZERO	5 500			
DC1040	DEFAULT	6	9	Climb	MaxClimb	ZERO	7 500			
DC1040	DEFAULT	6	10	Climb	MaxClimb	ZERO	10 000			
DC1040	DEFAULT	7	1	Takeoff	MaxTakeoff	15				
DC1040	DEFAULT	7	2	Climb	MaxTakeoff	15	1 000			
DC1040	DEFAULT	7	3	Accelerate	MaxTakeoff	15		1 170	211	
DC1040	DEFAULT	7	4	Accelerate	MaxTakeoff	5		878	226	
DC1040	DEFAULT	7	5	Accelerate	MaxClimb	INT		800	241	
DC1040	DEFAULT	7	6	Climb	MaxClimb	ZERO	3 000			
DC1040	DEFAULT	7	7	Accelerate	MaxClimb	ZERO		800	250	

ACFTID	Profile_ID	Stage Length	Step Number	Step Type	Thrust Rating	Flap_ID	End Point Altitude (ft)	Rate Of Climb (ft/min)	End Point CAS (kt)	Accelerate_Percent (%)
DC1040	DEFAULT	7	8	Climb	MaxClimb	ZERO	5 500			
DC1040	DEFAULT	7	9	Climb	MaxClimb	ZERO	7 500			
DC1040	DEFAULT	7	10	Climb	MaxClimb	ZERO	10 000			
DC3	DEFAULT	1	1	Takeoff	MaxTakeoff	TO				
DC3	DEFAULT	1	2	Climb	MaxTakeoff	TO	400			
DC3	DEFAULT	1	3	Climb	MaxClimb	ZERO	3 000			
DC3	DEFAULT	1	4	Accelerate	MaxClimb	ZERO		1 000	126	
DC3	DEFAULT	1	5	Climb	MaxClimb	ZERO	5 500			
DC3	DEFAULT	1	6	Climb	MaxClimb	ZERO	7 500			
DC3	DEFAULT	1	7	Climb	MaxClimb	ZERO	10 000			
DC3	DEFAULT	2	1	Takeoff	MaxTakeoff	TO				
DC3	DEFAULT	2	2	Climb	MaxTakeoff	TO	400			
DC3	DEFAULT	2	3	Climb	MaxClimb	ZERO	3 000			
DC3	DEFAULT	2	4	Accelerate	MaxClimb	ZERO		800	130	
DC3	DEFAULT	2	5	Climb	MaxClimb	ZERO	5 500			
DC3	DEFAULT	2	6	Climb	MaxClimb	ZERO	7 500			
DC3	DEFAULT	2	7	Climb	MaxClimb	ZERO	10 000			
DC3	DEFAULT	3	1	Takeoff	MaxTakeoff	TO				
DC3	DEFAULT	3	2	Climb	MaxTakeoff	TO	400			
DC3	DEFAULT	3	3	Climb	MaxClimb	ZERO	3 000			

ACFTID	Profile_ID	Stage Length	Step Number	Step Type	Thrust Rating	Flap_ID	End Point Altitude (ft)	Rate Of Climb (ft/min)	End Point CAS (kt)	Accelerate_Percent (%)
DC3	DEFAULT	3	4	Accelerate	MaxClimb	ZERO		633	134	
DC3	DEFAULT	3	5	Climb	MaxClimb	ZERO	7 500			
DC3	DEFAULT	3	6	Climb	MaxClimb	ZERO	10 000			
DC6	DEFAULT	1	1	Takeoff	MaxTakeoff	TO				
DC6	DEFAULT	1	2	Climb	MaxTakeoff	TO	1 500			
DC6	DEFAULT	1	3	Accelerate	MaxTakeoff	TO		818	135	
DC6	DEFAULT	1	4	Climb	MaxClimb	ZERO	3 000			
DC6	DEFAULT	1	5	Climb	MaxClimb	ZERO	5 500			
DC6	DEFAULT	1	6	Climb	MaxClimb	ZERO	7 500			
DC6	DEFAULT	1	7	Climb	MaxClimb	ZERO	10 000			
DC6	DEFAULT	2	1	Takeoff	MaxTakeoff	TO				
DC6	DEFAULT	2	2	Climb	MaxTakeoff	TO	1 500			
DC6	DEFAULT	2	3	Accelerate	MaxTakeoff	TO		643	143	
DC6	DEFAULT	2	4	Climb	MaxClimb	ZERO	3 000			
DC6	DEFAULT	2	5	Climb	MaxClimb	ZERO	5 500			
DC6	DEFAULT	2	6	Climb	MaxClimb	ZERO	7 500			
DC6	DEFAULT	2	7	Climb	MaxClimb	ZERO	10 000			
DC6	DEFAULT	3	1	Takeoff	MaxTakeoff	TO				
DC6	DEFAULT	3	2	Climb	MaxTakeoff	TO	1 500			
DC6	DEFAULT	3	3	Accelerate	MaxTakeoff	TO		498	149	

ACFTID	Profile_ID	Stage Length	Step Number	Step Type	Thrust Rating	Flap_ID	End Point Altitude (ft)	Rate Of Climb (ft/min)	End Point CAS (kt)	Accelerate_Percent (%)
DC6	DEFAULT	3	4	Climb	MaxClimb	ZERO	3 000			
DC6	DEFAULT	3	5	Climb	MaxClimb	ZERO	5 500			
DC6	DEFAULT	3	6	Climb	MaxClimb	ZERO	7 500			
DC6	DEFAULT	3	7	Climb	MaxClimb	ZERO	10 000			
DC850	DEFAULT	1	1	Takeoff	MaxTakeoff	15				
DC850	DEFAULT	1	2	Climb	MaxTakeoff	15	1 000			
DC850	DEFAULT	1	3	Accelerate	MaxTakeoff	15		2 205	149	
DC850	DEFAULT	1	4	Accelerate	MaxTakeoff	INT		1 654	169	
DC850	DEFAULT	1	5	Accelerate	MaxClimb	INT		1 000	189	
DC850	DEFAULT	1	6	Climb	MaxClimb	ZERO	3 000			
DC850	DEFAULT	1	7	Accelerate	MaxClimb	ZERO		1 000	250	
DC850	DEFAULT	1	8	Climb	MaxClimb	ZERO	5 500			
DC850	DEFAULT	1	9	Climb	MaxClimb	ZERO	7 500			
DC850	DEFAULT	1	10	Climb	MaxClimb	ZERO	10 000			
DC850	DEFAULT	2	1	Takeoff	MaxTakeoff	15				
DC850	DEFAULT	2	2	Climb	MaxTakeoff	15	1 000			
DC850	DEFAULT	2	3	Accelerate	MaxTakeoff	15		2 089	153	
DC850	DEFAULT	2	4	Accelerate	MaxTakeoff	INT		1 567	173	
DC850	DEFAULT	2	5	Accelerate	MaxClimb	INT		1 000	193	
DC850	DEFAULT	2	6	Climb	MaxClimb	ZERO	3 000			

ACFTID	Profile_ID	Stage Length	Step Number	Step Type	Thrust Rating	Flap_ID	End Point Altitude (ft)	Rate Of Climb (ft/min)	End Point CAS (kt)	Accelerate_Percent (%)
DC850	DEFAULT	2	7	Accelerate	MaxClimb	ZERO		1 000	250	
DC850	DEFAULT	2	8	Climb	MaxClimb	ZERO	5 500			
DC850	DEFAULT	2	9	Climb	MaxClimb	ZERO	7 500			
DC850	DEFAULT	2	10	Climb	MaxClimb	ZERO	10 000			
DC850	DEFAULT	3	1	Takeoff	MaxTakeoff	15				
DC850	DEFAULT	3	2	Climb	MaxTakeoff	15	1 000			
DC850	DEFAULT	3	3	Accelerate	MaxTakeoff	15		1 930	158	
DC850	DEFAULT	3	4	Accelerate	MaxTakeoff	INT		1 448	178	
DC850	DEFAULT	3	5	Accelerate	MaxClimb	INT		1 000	198	
DC850	DEFAULT	3	6	Climb	MaxClimb	ZERO	3 000			
DC850	DEFAULT	3	7	Accelerate	MaxClimb	ZERO		1 000	250	
DC850	DEFAULT	3	8	Climb	MaxClimb	ZERO	5 500			
DC850	DEFAULT	3	9	Climb	MaxClimb	ZERO	7 500			
DC850	DEFAULT	3	10	Climb	MaxClimb	ZERO	10 000			
DC850	DEFAULT	4	1	Takeoff	MaxTakeoff	15				
DC850	DEFAULT	4	2	Climb	MaxTakeoff	15	1 000			
DC850	DEFAULT	4	3	Accelerate	MaxTakeoff	15		1 743	165	
DC850	DEFAULT	4	4	Accelerate	MaxTakeoff	INT		1 308	185	
DC850	DEFAULT	4	5	Accelerate	MaxClimb	INT		1 000	205	
DC850	DEFAULT	4	6	Climb	MaxClimb	ZERO	3 000			

ACFTID	Profile_ID	Stage Length	Step Number	Step Type	Thrust Rating	Flap_ID	End Point Altitude (ft)	Rate Of Climb (ft/min)	End Point CAS (kt)	Accelerate_Percent (%)
DC850	DEFAULT	4	7	Accelerate	MaxClimb	ZERO		1 000	250	
DC850	DEFAULT	4	8	Climb	MaxClimb	ZERO	5 500			
DC850	DEFAULT	4	9	Climb	MaxClimb	ZERO	7 500			
DC850	DEFAULT	4	10	Climb	MaxClimb	ZERO	10 000			
DC850	DEFAULT	5	1	Takeoff	MaxTakeoff	15				
DC850	DEFAULT	5	2	Climb	MaxTakeoff	15	1 000			
DC850	DEFAULT	5	3	Accelerate	MaxTakeoff	15		1 541	173	
DC850	DEFAULT	5	4	Accelerate	MaxTakeoff	INT		1 156	193	
DC850	DEFAULT	5	5	Accelerate	MaxClimb	INT		1 000	213	
DC850	DEFAULT	5	6	Climb	MaxClimb	ZERO	3 000			
DC850	DEFAULT	5	7	Accelerate	MaxClimb	ZERO		1 000	250	
DC850	DEFAULT	5	8	Climb	MaxClimb	ZERO	5 500			
DC850	DEFAULT	5	9	Climb	MaxClimb	ZERO	7 500			
DC850	DEFAULT	5	10	Climb	MaxClimb	ZERO	10 000			
DC850	DEFAULT	6	1	Takeoff	MaxTakeoff	15				
DC850	DEFAULT	6	2	Climb	MaxTakeoff	15	1 000			
DC850	DEFAULT	6	3	Accelerate	MaxTakeoff	15		1 397	180	
DC850	DEFAULT	6	4	Accelerate	MaxTakeoff	INT		1 048	200	
DC850	DEFAULT	6	5	Accelerate	MaxClimb	INT		1 000	220	
DC850	DEFAULT	6	6	Climb	MaxClimb	ZERO	3 000			

ACFTID	Profile_ID	Stage Length	Step Number	Step Type	Thrust Rating	Flap_ID	End Point Altitude (ft)	Rate Of Climb (ft/min)	End Point CAS (kt)	Accelerate_Percent (%)
DC850	DEFAULT	6	7	Accelerate	MaxClimb	ZERO		1 000	250	
DC850	DEFAULT	6	8	Climb	MaxClimb	ZERO	5 500			
DC850	DEFAULT	6	9	Climb	MaxClimb	ZERO	7 500			
DC850	DEFAULT	6	10	Climb	MaxClimb	ZERO	10 000			
DC860	DEFAULT	1	1	Takeoff	MaxTakeoff	12				
DC860	DEFAULT	1	2	Climb	MaxTakeoff	12	1 000			
DC860	DEFAULT	1	3	Accelerate	MaxTakeoff	12		2 055	160	
DC860	DEFAULT	1	4	Accelerate	MaxTakeoff	INT		1 541	180	
DC860	DEFAULT	1	5	Accelerate	MaxClimb	INT		1 000	200	
DC860	DEFAULT	1	6	Climb	MaxClimb	ZERO	3 000			
DC860	DEFAULT	1	7	Accelerate	MaxClimb	ZERO		1 000	250	
DC860	DEFAULT	1	8	Climb	MaxClimb	ZERO	5 500			
DC860	DEFAULT	1	9	Climb	MaxClimb	ZERO	7 500			
DC860	DEFAULT	1	10	Climb	MaxClimb	ZERO	10 000			
DC860	DEFAULT	2	1	Takeoff	MaxTakeoff	12				
DC860	DEFAULT	2	2	Climb	MaxTakeoff	12	1 000			
DC860	DEFAULT	2	3	Accelerate	MaxTakeoff	12		1 959	164	
DC860	DEFAULT	2	4	Accelerate	MaxTakeoff	INT		1 470	184	
DC860	DEFAULT	2	5	Accelerate	MaxClimb	INT		1 000	204	
DC860	DEFAULT	2	6	Climb	MaxClimb	ZERO	3 000			

ACFTID	Profile_ID	Stage Length	Step Number	Step Type	Thrust Rating	Flap_ID	End Point Altitude (ft)	Rate Of Climb (ft/min)	End Point CAS (kt)	Accelerate_Percent (%)
DC860	DEFAULT	2	7	Accelerate	MaxClimb	ZERO		1 000	250	
DC860	DEFAULT	2	8	Climb	MaxClimb	ZERO	5 500			
DC860	DEFAULT	2	9	Climb	MaxClimb	ZERO	7 500			
DC860	DEFAULT	2	10	Climb	MaxClimb	ZERO	10 000			
DC860	DEFAULT	3	1	Takeoff	MaxTakeoff	12				
DC860	DEFAULT	3	2	Climb	MaxTakeoff	12	1 000			
DC860	DEFAULT	3	3	Accelerate	MaxTakeoff	12		1 827	168	
DC860	DEFAULT	3	4	Accelerate	MaxTakeoff	INT		1 371	188	
DC860	DEFAULT	3	5	Accelerate	MaxClimb	INT		1 000	208	
DC860	DEFAULT	3	6	Climb	MaxClimb	ZERO	3 000			
DC860	DEFAULT	3	7	Accelerate	MaxClimb	ZERO		1 000	250	
DC860	DEFAULT	3	8	Climb	MaxClimb	ZERO	5 500			
DC860	DEFAULT	3	9	Climb	MaxClimb	ZERO	7 500			
DC860	DEFAULT	3	10	Climb	MaxClimb	ZERO	10 000			
DC860	DEFAULT	4	1	Takeoff	MaxTakeoff	12				
DC860	DEFAULT	4	2	Climb	MaxTakeoff	12	1 000			
DC860	DEFAULT	4	3	Accelerate	MaxTakeoff	12		1 668	175	
DC860	DEFAULT	4	4	Accelerate	MaxTakeoff	INT		1 251	195	
DC860	DEFAULT	4	5	Accelerate	MaxClimb	INT		1 000	215	
DC860	DEFAULT	4	6	Climb	MaxClimb	ZERO	3 000			

ACFTID	Profile_ID	Stage Length	Step Number	Step Type	Thrust Rating	Flap_ID	End Point Altitude (ft)	Rate Of Climb (ft/min)	End Point CAS (kt)	Accelerate_Percent (%)
DC860	DEFAULT	4	7	Accelerate	MaxClimb	ZERO		1 000	250	
DC860	DEFAULT	4	8	Climb	MaxClimb	ZERO	5 500			
DC860	DEFAULT	4	9	Climb	MaxClimb	ZERO	7 500			
DC860	DEFAULT	4	10	Climb	MaxClimb	ZERO	10 000			
DC860	DEFAULT	5	1	Takeoff	MaxTakeoff	12				
DC860	DEFAULT	5	2	Climb	MaxTakeoff	12	1 000			
DC860	DEFAULT	5	3	Accelerate	MaxTakeoff	12		1 491	182	
DC860	DEFAULT	5	4	Accelerate	MaxTakeoff	INT		1 118	202	
DC860	DEFAULT	5	5	Accelerate	MaxClimb	INT		1 000	222	
DC860	DEFAULT	5	6	Climb	MaxClimb	ZERO	3 000			
DC860	DEFAULT	5	7	Accelerate	MaxClimb	ZERO		1 000	250	
DC860	DEFAULT	5	8	Climb	MaxClimb	ZERO	5 500			
DC860	DEFAULT	5	9	Climb	MaxClimb	ZERO	7 500			
DC860	DEFAULT	5	10	Climb	MaxClimb	ZERO	10 000			
DC860	DEFAULT	6	1	Takeoff	MaxTakeoff	12				
DC860	DEFAULT	6	2	Climb	MaxTakeoff	12	1 000			
DC860	DEFAULT	6	3	Accelerate	MaxTakeoff	12		1 394	187	
DC860	DEFAULT	6	4	Accelerate	MaxTakeoff	INT		1 046	207	
DC860	DEFAULT	6	5	Accelerate	MaxClimb	INT		1 000	227	
DC860	DEFAULT	6	6	Climb	MaxClimb	ZERO	3 000			

ACFTID	Profile_ID	Stage Length	Step Number	Step Type	Thrust Rating	Flap_ID	End Point Altitude (ft)	Rate Of Climb (ft/min)	End Point CAS (kt)	Accelerate_Percent (%)
DC860	DEFAULT	6	7	Accelerate	MaxClimb	ZERO		1 000	250	
DC860	DEFAULT	6	8	Climb	MaxClimb	ZERO	5 500			
DC860	DEFAULT	6	9	Climb	MaxClimb	ZERO	7 500			
DC860	DEFAULT	6	10	Climb	MaxClimb	ZERO	10 000			
DC860	DEFAULT	7	1	Takeoff	MaxTakeoff	12				
DC860	DEFAULT	7	2	Climb	MaxTakeoff	12	1 000			
DC860	DEFAULT	7	3	Accelerate	MaxTakeoff	12		1 275	192	
DC860	DEFAULT	7	4	Accelerate	MaxTakeoff	INT		956	212	
DC860	DEFAULT	7	5	Accelerate	MaxClimb	INT		900	232	
DC860	DEFAULT	7	6	Climb	MaxClimb	ZERO	3 000			
DC860	DEFAULT	7	7	Accelerate	MaxClimb	ZERO		900	250	
DC860	DEFAULT	7	8	Climb	MaxClimb	ZERO	5 500			
DC860	DEFAULT	7	9	Climb	MaxClimb	ZERO	7 500			
DC860	DEFAULT	7	10	Climb	MaxClimb	ZERO	10 000			
DC870	DEFAULT	1	1	Takeoff	MaxTakeoff	12				
DC870	DEFAULT	1	2	Climb	MaxTakeoff	12	1 000			
DC870	DEFAULT	1	3	Accelerate	MaxTakeoff	12		2 405	160	
DC870	DEFAULT	1	4	Accelerate	MaxTakeoff	INT		1 804	180	
DC870	DEFAULT	1	5	Accelerate	MaxClimb	INT		1 000	200	
DC870	DEFAULT	1	6	Climb	MaxClimb	ZERO	3 000			

ACFTID	Profile_ID	Stage Length	Step Number	Step Type	Thrust Rating	Flap_ID	End Point Altitude (ft)	Rate Of Climb (ft/min)	End Point CAS (kt)	Accelerate_Percent (%)
DC870	DEFAULT	1	7	Accelerate	MaxClimb	ZERO		1 000	250	
DC870	DEFAULT	1	8	Climb	MaxClimb	ZERO	5 500			
DC870	DEFAULT	1	9	Climb	MaxClimb	ZERO	7 500			
DC870	DEFAULT	1	10	Climb	MaxClimb	ZERO	10 000			
DC870	DEFAULT	2	1	Takeoff	MaxTakeoff	12				
DC870	DEFAULT	2	2	Climb	MaxTakeoff	12	1 000			
DC870	DEFAULT	2	3	Accelerate	MaxTakeoff	12		2 289	164	
DC870	DEFAULT	2	4	Accelerate	MaxTakeoff	INT		1 717	184	
DC870	DEFAULT	2	5	Accelerate	MaxClimb	INT		1 000	204	
DC870	DEFAULT	2	6	Climb	MaxClimb	ZERO	3 000			
DC870	DEFAULT	2	7	Accelerate	MaxClimb	ZERO		1 000	250	
DC870	DEFAULT	2	8	Climb	MaxClimb	ZERO	5 500			
DC870	DEFAULT	2	9	Climb	MaxClimb	ZERO	7 500			
DC870	DEFAULT	2	10	Climb	MaxClimb	ZERO	10 000			
DC870	DEFAULT	3	1	Takeoff	MaxTakeoff	12				
DC870	DEFAULT	3	2	Climb	MaxTakeoff	12	1 000			
DC870	DEFAULT	3	3	Accelerate	MaxTakeoff	12		2 129	168	
DC870	DEFAULT	3	4	Accelerate	MaxTakeoff	INT		1 597	188	
DC870	DEFAULT	3	5	Accelerate	MaxClimb	INT		1 000	208	
DC870	DEFAULT	3	6	Climb	MaxClimb	ZERO	3 000			

ACFTID	Profile_ID	Stage Length	Step Number	Step Type	Thrust Rating	Flap_ID	End Point Altitude (ft)	Rate Of Climb (ft/min)	End Point CAS (kt)	Accelerate_Percent (%)
DC870	DEFAULT	3	7	Accelerate	MaxClimb	ZERO		1 000	250	
DC870	DEFAULT	3	8	Climb	MaxClimb	ZERO	5 500			
DC870	DEFAULT	3	9	Climb	MaxClimb	ZERO	7 500			
DC870	DEFAULT	3	10	Climb	MaxClimb	ZERO	10 000			
DC870	DEFAULT	4	1	Takeoff	MaxTakeoff	12				
DC870	DEFAULT	4	2	Climb	MaxTakeoff	12	1 000			
DC870	DEFAULT	4	3	Accelerate	MaxTakeoff	12		1 938	175	
DC870	DEFAULT	4	4	Accelerate	MaxTakeoff	INT		1 454	195	
DC870	DEFAULT	4	5	Accelerate	MaxClimb	INT		1 000	215	
DC870	DEFAULT	4	6	Climb	MaxClimb	ZERO	3 000			
DC870	DEFAULT	4	7	Accelerate	MaxClimb	ZERO		1 000	250	
DC870	DEFAULT	4	8	Climb	MaxClimb	ZERO	5 500			
DC870	DEFAULT	4	9	Climb	MaxClimb	ZERO	7 500			
DC870	DEFAULT	4	10	Climb	MaxClimb	ZERO	10 000			
DC870	DEFAULT	5	1	Takeoff	MaxTakeoff	12				
DC870	DEFAULT	5	2	Climb	MaxTakeoff	12	1 000			
DC870	DEFAULT	5	3	Accelerate	MaxTakeoff	12		1 727	182	
DC870	DEFAULT	5	4	Accelerate	MaxTakeoff	INT		1 295	202	
DC870	DEFAULT	5	5	Accelerate	MaxClimb	INT		1 000	222	
DC870	DEFAULT	5	6	Climb	MaxClimb	ZERO	3 000			

ACFTID	Profile_ID	Stage Length	Step Number	Step Type	Thrust Rating	Flap_ID	End Point Altitude (ft)	Rate Of Climb (ft/min)	End Point CAS (kt)	Accelerate_Percent (%)
DC870	DEFAULT	5	7	Accelerate	MaxClimb	ZERO		1 000	250	
DC870	DEFAULT	5	8	Climb	MaxClimb	ZERO	5 500			
DC870	DEFAULT	5	9	Climb	MaxClimb	ZERO	7 500			
DC870	DEFAULT	5	10	Climb	MaxClimb	ZERO	10 000			
DC870	DEFAULT	6	1	Takeoff	MaxTakeoff	12				
DC870	DEFAULT	6	2	Climb	MaxTakeoff	12	1 000			
DC870	DEFAULT	6	3	Accelerate	MaxTakeoff	12		1 611	187	
DC870	DEFAULT	6	4	Accelerate	MaxTakeoff	INT		1 209	207	
DC870	DEFAULT	6	5	Accelerate	MaxClimb	INT		1 000	227	
DC870	DEFAULT	6	6	Climb	MaxClimb	ZERO	3 000			
DC870	DEFAULT	6	7	Accelerate	MaxClimb	ZERO		1 000	250	
DC870	DEFAULT	6	8	Climb	MaxClimb	ZERO	5 500			
DC870	DEFAULT	6	9	Climb	MaxClimb	ZERO	7 500			
DC870	DEFAULT	6	10	Climb	MaxClimb	ZERO	10 000			
DC870	DEFAULT	7	1	Takeoff	MaxTakeoff	12				
DC870	DEFAULT	7	2	Climb	MaxTakeoff	12	1 000			
DC870	DEFAULT	7	3	Accelerate	MaxTakeoff	12		1 470	192	
DC870	DEFAULT	7	4	Accelerate	MaxTakeoff	INT		1 103	212	
DC870	DEFAULT	7	5	Accelerate	MaxClimb	INT		1 000	232	
DC870	DEFAULT	7	6	Climb	MaxClimb	ZERO	3 000			

ACFTID	Profile_ID	Stage Length	Step Number	Step Type	Thrust Rating	Flap_ID	End Point Altitude (ft)	Rate Of Climb (ft/min)	End Point CAS (kt)	Accelerate_Percent (%)
DC870	DEFAULT	7	7	Accelerate	MaxClimb	ZERO		1 000	250	
DC870	DEFAULT	7	8	Climb	MaxClimb	ZERO	5 500			
DC870	DEFAULT	7	9	Climb	MaxClimb	ZERO	7 500			
DC870	DEFAULT	7	10	Climb	MaxClimb	ZERO	10 000			
DC8QN	DEFAULT	1	1	Takeoff	MaxTakeoff	12				
DC8QN	DEFAULT	1	2	Climb	MaxTakeoff	12	1 000			
DC8QN	DEFAULT	1	3	Accelerate	MaxTakeoff	12		2 055	160	
DC8QN	DEFAULT	1	4	Accelerate	MaxTakeoff	INT		1 541	180	
DC8QN	DEFAULT	1	5	Accelerate	MaxClimb	INT		1 000	200	
DC8QN	DEFAULT	1	6	Climb	MaxClimb	ZERO	3 000			
DC8QN	DEFAULT	1	7	Accelerate	MaxClimb	ZERO		1 000	250	
DC8QN	DEFAULT	1	8	Climb	MaxClimb	ZERO	5 500			
DC8QN	DEFAULT	1	9	Climb	MaxClimb	ZERO	7 500			
DC8QN	DEFAULT	1	10	Climb	MaxClimb	ZERO	10 000			
DC8QN	DEFAULT	2	1	Takeoff	MaxTakeoff	12				
DC8QN	DEFAULT	2	2	Climb	MaxTakeoff	12	1 000			
DC8QN	DEFAULT	2	3	Accelerate	MaxTakeoff	12		1 959	164	
DC8QN	DEFAULT	2	4	Accelerate	MaxTakeoff	INT		1 470	184	
DC8QN	DEFAULT	2	5	Accelerate	MaxClimb	INT		1 000	204	
DC8QN	DEFAULT	2	6	Climb	MaxClimb	ZERO	3 000			

ACFTID	Profile_ID	Stage Length	Step Number	Step Type	Thrust Rating	Flap_ID	End Point Altitude (ft)	Rate Of Climb (ft/min)	End Point CAS (kt)	Accelerate_Percent (%)
DC8QN	DEFAULT	2	7	Accelerate	MaxClimb	ZERO		1 000	250	
DC8QN	DEFAULT	2	8	Climb	MaxClimb	ZERO	5 500			
DC8QN	DEFAULT	2	9	Climb	MaxClimb	ZERO	7 500			
DC8QN	DEFAULT	2	10	Climb	MaxClimb	ZERO	10 000			
DC8QN	DEFAULT	3	1	Takeoff	MaxTakeoff	12				
DC8QN	DEFAULT	3	2	Climb	MaxTakeoff	12	1 000			
DC8QN	DEFAULT	3	3	Accelerate	MaxTakeoff	12		1 827	168	
DC8QN	DEFAULT	3	4	Accelerate	MaxTakeoff	INT		1 371	188	
DC8QN	DEFAULT	3	5	Accelerate	MaxClimb	INT		1 000	208	
DC8QN	DEFAULT	3	6	Climb	MaxClimb	ZERO	3 000			
DC8QN	DEFAULT	3	7	Accelerate	MaxClimb	ZERO		1 000	250	
DC8QN	DEFAULT	3	8	Climb	MaxClimb	ZERO	5 500			
DC8QN	DEFAULT	3	9	Climb	MaxClimb	ZERO	7 500			
DC8QN	DEFAULT	3	10	Climb	MaxClimb	ZERO	10 000			
DC8QN	DEFAULT	4	1	Takeoff	MaxTakeoff	12				
DC8QN	DEFAULT	4	2	Climb	MaxTakeoff	12	1 000			
DC8QN	DEFAULT	4	3	Accelerate	MaxTakeoff	12		1 668	175	
DC8QN	DEFAULT	4	4	Accelerate	MaxTakeoff	INT		1 251	195	
DC8QN	DEFAULT	4	5	Accelerate	MaxClimb	INT		1 000	215	
DC8QN	DEFAULT	4	6	Climb	MaxClimb	ZERO	3 000			

ACFTID	Profile_ID	Stage Length	Step Number	Step Type	Thrust Rating	Flap_ID	End Point Altitude (ft)	Rate Of Climb (ft/min)	End Point CAS (kt)	Accelerate_Percent (%)
DC8QN	DEFAULT	4	7	Accelerate	MaxClimb	ZERO		1 000	250	
DC8QN	DEFAULT	4	8	Climb	MaxClimb	ZERO	5 500			
DC8QN	DEFAULT	4	9	Climb	MaxClimb	ZERO	7 500			
DC8QN	DEFAULT	4	10	Climb	MaxClimb	ZERO	10 000			
DC8QN	DEFAULT	5	1	Takeoff	MaxTakeoff	12				
DC8QN	DEFAULT	5	2	Climb	MaxTakeoff	12	1 000			
DC8QN	DEFAULT	5	3	Accelerate	MaxTakeoff	12		1 491	182	
DC8QN	DEFAULT	5	4	Accelerate	MaxTakeoff	INT		1 118	202	
DC8QN	DEFAULT	5	5	Accelerate	MaxClimb	INT		1 000	222	
DC8QN	DEFAULT	5	6	Climb	MaxClimb	ZERO	3 000			
DC8QN	DEFAULT	5	7	Accelerate	MaxClimb	ZERO		1 000	250	
DC8QN	DEFAULT	5	8	Climb	MaxClimb	ZERO	5 500			
DC8QN	DEFAULT	5	9	Climb	MaxClimb	ZERO	7 500			
DC8QN	DEFAULT	5	10	Climb	MaxClimb	ZERO	10 000			
DC8QN	DEFAULT	6	1	Takeoff	MaxTakeoff	12				
DC8QN	DEFAULT	6	2	Climb	MaxTakeoff	12	1 000			
DC8QN	DEFAULT	6	3	Accelerate	MaxTakeoff	12		1 394	187	
DC8QN	DEFAULT	6	4	Accelerate	MaxTakeoff	INT		1 046	207	
DC8QN	DEFAULT	6	5	Accelerate	MaxClimb	INT		1 000	227	
DC8QN	DEFAULT	6	6	Climb	MaxClimb	ZERO	3 000			

ACFTID	Profile_ID	Stage Length	Step Number	Step Type	Thrust Rating	Flap_ID	End Point Altitude (ft)	Rate Of Climb (ft/min)	End Point CAS (kt)	Accelerate_Percent (%)
DC8QN	DEFAULT	6	7	Accelerate	MaxClimb	ZERO		1 000	250	
DC8QN	DEFAULT	6	8	Climb	MaxClimb	ZERO	5 500			
DC8QN	DEFAULT	6	9	Climb	MaxClimb	ZERO	7 500			
DC8QN	DEFAULT	6	10	Climb	MaxClimb	ZERO	10 000			
DC8QN	DEFAULT	7	1	Takeoff	MaxTakeoff	12				
DC8QN	DEFAULT	7	2	Climb	MaxTakeoff	12	1 000			
DC8QN	DEFAULT	7	3	Accelerate	MaxTakeoff	12		1 275	192	
DC8QN	DEFAULT	7	4	Accelerate	MaxTakeoff	INT		956	212	
DC8QN	DEFAULT	7	5	Accelerate	MaxClimb	INT		900	232	
DC8QN	DEFAULT	7	6	Climb	MaxClimb	ZERO	3 000			
DC8QN	DEFAULT	7	7	Accelerate	MaxClimb	ZERO		900	250	
DC8QN	DEFAULT	7	8	Climb	MaxClimb	ZERO	5 500			
DC8QN	DEFAULT	7	9	Climb	MaxClimb	ZERO	7 500			
DC8QN	DEFAULT	7	10	Climb	MaxClimb	ZERO	10 000			
DC910	DEFAULT	1	1	Takeoff	MaxTakeoff	15				
DC910	DEFAULT	1	2	Climb	MaxTakeoff	15	1 000			
DC910	DEFAULT	1	3	Accelerate	MaxTakeoff	15		2 296	136	
DC910	DEFAULT	1	4	Accelerate	MaxTakeoff	5		1 722	146	
DC910	DEFAULT	1	5	Accelerate	MaxClimb	INT		1 000	181	
DC910	DEFAULT	1	6	Climb	MaxClimb	ZERO	3 000			

ACFTID	Profile_ID	Stage Length	Step Number	Step Type	Thrust Rating	Flap_ID	End Point Altitude (ft)	Rate Of Climb (ft/min)	End Point CAS (kt)	Accelerate_Percent (%)
DC910	DEFAULT	1	7	Accelerate	MaxClimb	ZERO		1 000	250	
DC910	DEFAULT	1	8	Climb	MaxClimb	ZERO	5 500			
DC910	DEFAULT	1	9	Climb	MaxClimb	ZERO	7 500			
DC910	DEFAULT	1	10	Climb	MaxClimb	ZERO	10 000			
DC910	DEFAULT	2	1	Takeoff	MaxTakeoff	15				
DC910	DEFAULT	2	2	Climb	MaxTakeoff	15	1 000			
DC910	DEFAULT	2	3	Accelerate	MaxTakeoff	15		2 070	143	
DC910	DEFAULT	2	4	Accelerate	MaxTakeoff	5		1 553	153	
DC910	DEFAULT	2	5	Accelerate	MaxClimb	INT		1 000	188	
DC910	DEFAULT	2	6	Climb	MaxClimb	ZERO	3 000			
DC910	DEFAULT	2	7	Accelerate	MaxClimb	ZERO		1 000	250	
DC910	DEFAULT	2	8	Climb	MaxClimb	ZERO	5 500			
DC910	DEFAULT	2	9	Climb	MaxClimb	ZERO	7 500			
DC910	DEFAULT	2	10	Climb	MaxClimb	ZERO	10 000			
DC910	DEFAULT	3	1	Takeoff	MaxTakeoff	15				
DC910	DEFAULT	3	2	Climb	MaxTakeoff	15	1 000			
DC910	DEFAULT	3	3	Accelerate	MaxTakeoff	15		1 901	149	
DC910	DEFAULT	3	4	Accelerate	MaxTakeoff	5		1 426	159	
DC910	DEFAULT	3	5	Accelerate	MaxClimb	INT		1 000	194	
DC910	DEFAULT	3	6	Climb	MaxClimb	ZERO	3 000			

ACFTID	Profile_ID	Stage Length	Step Number	Step Type	Thrust Rating	Flap_ID	End Point Altitude (ft)	Rate Of Climb (ft/min)	End Point CAS (kt)	Accelerate_Percent (%)
DC910	DEFAULT	3	7	Accelerate	MaxClimb	ZERO		1 000	250	
DC910	DEFAULT	3	8	Climb	MaxClimb	ZERO	5 500			
DC910	DEFAULT	3	9	Climb	MaxClimb	ZERO	7 500			
DC910	DEFAULT	3	10	Climb	MaxClimb	ZERO	10 000			
DC930	DEFAULT	1	1	Takeoff	MaxTakeoff	15				
DC930	DEFAULT	1	2	Climb	MaxTakeoff	15	1 000			
DC930	DEFAULT	1	3	Accelerate	MaxTakeoff	15		1 741	154	
DC930	DEFAULT	1	4	Accelerate	MaxTakeoff	5		1 306	164	
DC930	DEFAULT	1	5	Accelerate	MaxClimb	INT		1 000	199	
DC930	DEFAULT	1	6	Climb	MaxClimb	ZERO	3 000			
DC930	DEFAULT	1	7	Accelerate	MaxClimb	ZERO		1 000	250	
DC930	DEFAULT	1	8	Climb	MaxClimb	ZERO	5 500			
DC930	DEFAULT	1	9	Climb	MaxClimb	ZERO	7 500			
DC930	DEFAULT	1	10	Climb	MaxClimb	ZERO	10 000			
DC930	DEFAULT	2	1	Takeoff	MaxTakeoff	15				
DC930	DEFAULT	2	2	Climb	MaxTakeoff	15	1 000			
DC930	DEFAULT	2	3	Accelerate	MaxTakeoff	15		1 559	161	
DC930	DEFAULT	2	4	Accelerate	MaxTakeoff	5		1 169	171	
DC930	DEFAULT	2	5	Accelerate	MaxClimb	INT		1 000	206	
DC930	DEFAULT	2	6	Climb	MaxClimb	ZERO	3 000			

ACFTID	Profile_ID	Stage Length	Step Number	Step Type	Thrust Rating	Flap_ID	End Point Altitude (ft)	Rate Of Climb (ft/min)	End Point CAS (kt)	Accelerate_Percent (%)
DC930	DEFAULT	2	7	Accelerate	MaxClimb	ZERO		1 000	250	
DC930	DEFAULT	2	8	Climb	MaxClimb	ZERO	5 500			
DC930	DEFAULT	2	9	Climb	MaxClimb	ZERO	7 500			
DC930	DEFAULT	2	10	Climb	MaxClimb	ZERO	10 000			
DC930	DEFAULT	3	1	Takeoff	MaxTakeoff	15				
DC930	DEFAULT	3	2	Climb	MaxTakeoff	15	1 000			
DC930	DEFAULT	3	3	Accelerate	MaxTakeoff	15		1 406	168	
DC930	DEFAULT	3	4	Accelerate	MaxTakeoff	5		1 055	178	
DC930	DEFAULT	3	5	Accelerate	MaxClimb	INT		1 000	213	
DC930	DEFAULT	3	6	Climb	MaxClimb	ZERO	3 000			
DC930	DEFAULT	3	7	Accelerate	MaxClimb	ZERO		1 000	250	
DC930	DEFAULT	3	8	Climb	MaxClimb	ZERO	5 500			
DC930	DEFAULT	3	9	Climb	MaxClimb	ZERO	7 500			
DC930	DEFAULT	3	10	Climb	MaxClimb	ZERO	10 000			
DC931W	DEFAULT	1	1	Takeoff	MaxTakeoff	15				
DC931W	DEFAULT	1	2	Climb	MaxTakeoff	15	1 000			
DC931W	DEFAULT	1	3	Accelerate	MaxTakeoff	15		1 741	154	
DC931W	DEFAULT	1	4	Accelerate	MaxTakeoff	5		1 306	164	
DC931W	DEFAULT	1	5	Accelerate	MaxClimb	INT		1 000	199	
DC931W	DEFAULT	1	6	Climb	MaxClimb	ZERO	3 000			

ACFTID	Profile_ID	Stage Length	Step Number	Step Type	Thrust Rating	Flap_ID	End Point Altitude (ft)	Rate Of Climb (ft/min)	End Point CAS (kt)	Accelerate_Percent (%)
DC93LW	DEFAULT	1	7	Accelerate	MaxClimb	ZERO		1 000	250	
DC93LW	DEFAULT	1	8	Climb	MaxClimb	ZERO	5 500			
DC93LW	DEFAULT	1	9	Climb	MaxClimb	ZERO	7 500			
DC93LW	DEFAULT	1	10	Climb	MaxClimb	ZERO	10 000			
DC93LW	DEFAULT	2	1	Takeoff	MaxTakeoff	15				
DC93LW	DEFAULT	2	2	Climb	MaxTakeoff	15	1 000			
DC93LW	DEFAULT	2	3	Accelerate	MaxTakeoff	15		1 559	161	
DC93LW	DEFAULT	2	4	Accelerate	MaxTakeoff	5		1 169	171	
DC93LW	DEFAULT	2	5	Accelerate	MaxClimb	INT		1 000	206	
DC93LW	DEFAULT	2	6	Climb	MaxClimb	ZERO	3 000			
DC93LW	DEFAULT	2	7	Accelerate	MaxClimb	ZERO		1 000	250	
DC93LW	DEFAULT	2	8	Climb	MaxClimb	ZERO	5 500			
DC93LW	DEFAULT	2	9	Climb	MaxClimb	ZERO	7 500			
DC93LW	DEFAULT	2	10	Climb	MaxClimb	ZERO	10 000			
DC93LW	DEFAULT	3	1	Takeoff	MaxTakeoff	15				
DC93LW	DEFAULT	3	2	Climb	MaxTakeoff	15	1 000			
DC93LW	DEFAULT	3	3	Accelerate	MaxTakeoff	15		1 406	168	
DC93LW	DEFAULT	3	4	Accelerate	MaxTakeoff	5		1 055	178	
DC93LW	DEFAULT	3	5	Accelerate	MaxClimb	INT		1 000	213	
DC93LW	DEFAULT	3	6	Climb	MaxClimb	ZERO	3 000			

ACFTID	Profile_ID	Stage Length	Step Number	Step Type	Thrust Rating	Flap_ID	End Point Altitude (ft)	Rate Of Climb (ft/min)	End Point CAS (kt)	Accelerate_Percent (%)
DC93LW	DEFAULT	3	7	Accelerate	MaxClimb	ZERO		1 000	250	
DC93LW	DEFAULT	3	8	Climb	MaxClimb	ZERO	5 500			
DC93LW	DEFAULT	3	9	Climb	MaxClimb	ZERO	7 500			
DC93LW	DEFAULT	3	10	Climb	MaxClimb	ZERO	10 000			
DC950	DEFAULT	1	1	Takeoff	MaxTakeoff	15				
DC950	DEFAULT	1	2	Climb	MaxTakeoff	15	1 000			
DC950	DEFAULT	1	3	Accelerate	MaxTakeoff	15		1 983	159	
DC950	DEFAULT	1	4	Accelerate	MaxTakeoff	5		1 487	169	
DC950	DEFAULT	1	5	Accelerate	MaxClimb	INTR		1 000	204	
DC950	DEFAULT	1	6	Climb	MaxClimb	ZERO	3 000			
DC950	DEFAULT	1	7	Accelerate	MaxClimb	ZERO		1 000	250	
DC950	DEFAULT	1	8	Climb	MaxClimb	ZERO	5 500			
DC950	DEFAULT	1	9	Climb	MaxClimb	ZERO	7 500			
DC950	DEFAULT	1	10	Climb	MaxClimb	ZERO	10 000			
DC950	DEFAULT	2	1	Takeoff	MaxTakeoff	15				
DC950	DEFAULT	2	2	Climb	MaxTakeoff	15	1 000			
DC950	DEFAULT	2	3	Accelerate	MaxTakeoff	15		1 843	164	
DC950	DEFAULT	2	4	Accelerate	MaxTakeoff	5		1 382	174	
DC950	DEFAULT	2	5	Accelerate	MaxClimb	INTR		1 000	209	
DC950	DEFAULT	2	6	Climb	MaxClimb	ZERO	3 000			

ACFTID	Profile_ID	Stage Length	Step Number	Step Type	Thrust Rating	Flap_ID	End Point Altitude (ft)	Rate Of Climb (ft/min)	End Point CAS (kt)	Accelerate_Percent (%)
DC950	DEFAULT	2	7	Accelerate	MaxClimb	ZERO		1 000	250	
DC950	DEFAULT	2	8	Climb	MaxClimb	ZERO	5 500			
DC950	DEFAULT	2	9	Climb	MaxClimb	ZERO	7 500			
DC950	DEFAULT	2	10	Climb	MaxClimb	ZERO	10 000			
DC950	DEFAULT	3	1	Takeoff	MaxTakeoff	15				
DC950	DEFAULT	3	2	Climb	MaxTakeoff	15	1 000			
DC950	DEFAULT	3	3	Accelerate	MaxTakeoff	15		1 698	170	
DC950	DEFAULT	3	4	Accelerate	MaxTakeoff	5		1 274	180	
DC950	DEFAULT	3	5	Accelerate	MaxClimb	INTR		1 000	215	
DC950	DEFAULT	3	6	Climb	MaxClimb	ZERO	3 000			
DC950	DEFAULT	3	7	Accelerate	MaxClimb	ZERO		1 000	250	
DC950	DEFAULT	3	8	Climb	MaxClimb	ZERO	5 500			
DC950	DEFAULT	3	9	Climb	MaxClimb	ZERO	7 500			
DC950	DEFAULT	3	10	Climb	MaxClimb	ZERO	10 000			
DC95HW	DEFAULT	1	1	Takeoff	MaxTakeoff	15				
DC95HW	DEFAULT	1	2	Climb	MaxTakeoff	15	1 000			
DC95HW	DEFAULT	1	3	Accelerate	MaxTakeoff	15		1 983	159	
DC95HW	DEFAULT	1	4	Accelerate	MaxTakeoff	5		1 487	169	
DC95HW	DEFAULT	1	5	Accelerate	MaxClimb	INTR		1 000	204	
DC95HW	DEFAULT	1	6	Climb	MaxClimb	ZERO	3 000			

ACFTID	Profile_ID	Stage Length	Step Number	Step Type	Thrust Rating	Flap_ID	End Point Altitude (ft)	Rate Of Climb (ft/min)	End Point CAS (kt)	Accelerate_Percent (%)
DC95HW	DEFAULT	1	7	Accelerate	MaxClimb	ZERO		1 000	250	
DC95HW	DEFAULT	1	8	Climb	MaxClimb	ZERO	5 500			
DC95HW	DEFAULT	1	9	Climb	MaxClimb	ZERO	7 500			
DC95HW	DEFAULT	1	10	Climb	MaxClimb	ZERO	10 000			
DC95HW	DEFAULT	2	1	Takeoff	MaxTakeoff	15				
DC95HW	DEFAULT	2	2	Climb	MaxTakeoff	15	1 000			
DC95HW	DEFAULT	2	3	Accelerate	MaxTakeoff	15		1 843	164	
DC95HW	DEFAULT	2	4	Accelerate	MaxTakeoff	5		1 382	174	
DC95HW	DEFAULT	2	5	Accelerate	MaxClimb	INTR		1 000	209	
DC95HW	DEFAULT	2	6	Climb	MaxClimb	ZERO	3 000			
DC95HW	DEFAULT	2	7	Accelerate	MaxClimb	ZERO		1 000	250	
DC95HW	DEFAULT	2	8	Climb	MaxClimb	ZERO	5 500			
DC95HW	DEFAULT	2	9	Climb	MaxClimb	ZERO	7 500			
DC95HW	DEFAULT	2	10	Climb	MaxClimb	ZERO	10 000			
DC95HW	DEFAULT	3	1	Takeoff	MaxTakeoff	15				
DC95HW	DEFAULT	3	2	Climb	MaxTakeoff	15	1 000			
DC95HW	DEFAULT	3	3	Accelerate	MaxTakeoff	15		1 698	170	
DC95HW	DEFAULT	3	4	Accelerate	MaxTakeoff	5		1 274	180	
DC95HW	DEFAULT	3	5	Accelerate	MaxClimb	INTR		1 000	215	
DC95HW	DEFAULT	3	6	Climb	MaxClimb	ZERO	3 000			

ACFTID	Profile_ID	Stage Length	Step Number	Step Type	Thrust Rating	Flap_ID	End Point Altitude (ft)	Rate Of Climb (ft/min)	End Point CAS (kt)	Accelerate_Percent (%)
DC95HW	DEFAULT	3	7	Accelerate	MaxClimb	ZERO		1 000	250	
DC95HW	DEFAULT	3	8	Climb	MaxClimb	ZERO	5 500			
DC95HW	DEFAULT	3	9	Climb	MaxClimb	ZERO	7 500			
DC95HW	DEFAULT	3	10	Climb	MaxClimb	ZERO	10 000			
DC9Q7	DEFAULT	1	1	Takeoff	MaxTakeoff	15				
DC9Q7	DEFAULT	1	2	Climb	MaxTakeoff	15	1 000			
DC9Q7	DEFAULT	1	3	Accelerate	MaxTakeoff	15		2 296	136	
DC9Q7	DEFAULT	1	4	Accelerate	MaxTakeoff	5		1 722	146	
DC9Q7	DEFAULT	1	5	Accelerate	MaxClimb	INT		1 000	181	
DC9Q7	DEFAULT	1	6	Climb	MaxClimb	ZERO	3 000			
DC9Q7	DEFAULT	1	7	Accelerate	MaxClimb	ZERO		1 000	250	
DC9Q7	DEFAULT	1	8	Climb	MaxClimb	ZERO	5 500			
DC9Q7	DEFAULT	1	9	Climb	MaxClimb	ZERO	7 500			
DC9Q7	DEFAULT	1	10	Climb	MaxClimb	ZERO	10 000			
DC9Q7	DEFAULT	2	1	Takeoff	MaxTakeoff	15				
DC9Q7	DEFAULT	2	2	Climb	MaxTakeoff	15	1 000			
DC9Q7	DEFAULT	2	3	Accelerate	MaxTakeoff	15		2 070	143	
DC9Q7	DEFAULT	2	4	Accelerate	MaxTakeoff	5		1 553	153	
DC9Q7	DEFAULT	2	5	Accelerate	MaxClimb	INT		1 000	188	
DC9Q7	DEFAULT	2	6	Climb	MaxClimb	ZERO	3 000			

ACFTID	Profile_ID	Stage Length	Step Number	Step Type	Thrust Rating	Flap_ID	End Point Altitude (ft)	Rate Of Climb (ft/min)	End Point CAS (kt)	Accelerate_Percent (%)
DC9Q7	DEFAULT	2	7	Accelerate	MaxClimb	ZERO		1 000	250	
DC9Q7	DEFAULT	2	8	Climb	MaxClimb	ZERO	5 500			
DC9Q7	DEFAULT	2	9	Climb	MaxClimb	ZERO	7 500			
DC9Q7	DEFAULT	2	10	Climb	MaxClimb	ZERO	10 000			
DC9Q7	DEFAULT	3	1	Takeoff	MaxTakeoff	15				
DC9Q7	DEFAULT	3	2	Climb	MaxTakeoff	15	1 000			
DC9Q7	DEFAULT	3	3	Accelerate	MaxTakeoff	15		1 901	149	
DC9Q7	DEFAULT	3	4	Accelerate	MaxTakeoff	5		1 426	159	
DC9Q7	DEFAULT	3	5	Accelerate	MaxClimb	INT		1 000	194	
DC9Q7	DEFAULT	3	6	Climb	MaxClimb	ZERO	3 000			
DC9Q7	DEFAULT	3	7	Accelerate	MaxClimb	ZERO		1 000	250	
DC9Q7	DEFAULT	3	8	Climb	MaxClimb	ZERO	5 500			
DC9Q7	DEFAULT	3	9	Climb	MaxClimb	ZERO	7 500			
DC9Q7	DEFAULT	3	10	Climb	MaxClimb	ZERO	10 000			
DC9Q9	DEFAULT	1	1	Takeoff	MaxTakeoff	15				
DC9Q9	DEFAULT	1	2	Climb	MaxTakeoff	15	1 000			
DC9Q9	DEFAULT	1	3	Accelerate	MaxTakeoff	15		1 741	154	
DC9Q9	DEFAULT	1	4	Accelerate	MaxTakeoff	5		1 306	164	
DC9Q9	DEFAULT	1	5	Accelerate	MaxClimb	INT		1 000	199	
DC9Q9	DEFAULT	1	6	Climb	MaxClimb	ZERO	3 000			

ACFTID	Profile_ID	Stage Length	Step Number	Step Type	Thrust Rating	Flap_ID	End Point Altitude (ft)	Rate Of Climb (ft/min)	End Point CAS (kt)	Accelerate_Percent (%)
DC9Q9	DEFAULT	1	7	Accelerate	MaxClimb	ZERO		1 000	250	
DC9Q9	DEFAULT	1	8	Climb	MaxClimb	ZERO	5 500			
DC9Q9	DEFAULT	1	9	Climb	MaxClimb	ZERO	7 500			
DC9Q9	DEFAULT	1	10	Climb	MaxClimb	ZERO	10 000			
DC9Q9	DEFAULT	2	1	Takeoff	MaxTakeoff	15				
DC9Q9	DEFAULT	2	2	Climb	MaxTakeoff	15	1 000			
DC9Q9	DEFAULT	2	3	Accelerate	MaxTakeoff	15		1 559	161	
DC9Q9	DEFAULT	2	4	Accelerate	MaxTakeoff	5		1 169	171	
DC9Q9	DEFAULT	2	5	Accelerate	MaxClimb	INT		1 000	206	
DC9Q9	DEFAULT	2	6	Climb	MaxClimb	ZERO	3 000			
DC9Q9	DEFAULT	2	7	Accelerate	MaxClimb	ZERO		1 000	250	
DC9Q9	DEFAULT	2	8	Climb	MaxClimb	ZERO	5 500			
DC9Q9	DEFAULT	2	9	Climb	MaxClimb	ZERO	7 500			
DC9Q9	DEFAULT	2	10	Climb	MaxClimb	ZERO	10 000			
DC9Q9	DEFAULT	3	1	Takeoff	MaxTakeoff	15				
DC9Q9	DEFAULT	3	2	Climb	MaxTakeoff	15	1 000			
DC9Q9	DEFAULT	3	3	Accelerate	MaxTakeoff	15		1 406	168	
DC9Q9	DEFAULT	3	4	Accelerate	MaxTakeoff	5		1 055	178	
DC9Q9	DEFAULT	3	5	Accelerate	MaxClimb	INT		1 000	213	
DC9Q9	DEFAULT	3	6	Climb	MaxClimb	ZERO	3 000			

ACFTID	Profile_ID	Stage Length	Step Number	Step Type	Thrust Rating	Flap_ID	End Point Altitude (ft)	Rate Of Climb (ft/min)	End Point CAS (kt)	Accelerate_Percent (%)
DC9Q9	DEFAULT	3	7	Accelerate	MaxClimb	ZERO		1 000	250	
DC9Q9	DEFAULT	3	8	Climb	MaxClimb	ZERO	5 500			
DC9Q9	DEFAULT	3	9	Climb	MaxClimb	ZERO	7 500			
DC9Q9	DEFAULT	3	10	Climb	MaxClimb	ZERO	10 000			
DHC6	DEFAULT	1	1	Takeoff	MaxTakeoff	TO				
DHC6	DEFAULT	1	2	Climb	MaxTakeoff	TO	1 000			
DHC6	DEFAULT	1	3	Accelerate	MaxTakeoff	TO		952	98	
DHC6	DEFAULT	1	4	Climb	MaxClimb	ZERO	3 000			
DHC6	DEFAULT	1	5	Climb	MaxClimb	ZERO	5 500			
DHC6	DEFAULT	1	6	Climb	MaxClimb	ZERO	7 500			
DHC6	DEFAULT	1	7	Climb	MaxClimb	ZERO	10 000			
DHC6QP	DEFAULT	1	1	Takeoff	MaxTakeoff	TO				
DHC6QP	DEFAULT	1	2	Climb	MaxTakeoff	TO	1 000			
DHC6QP	DEFAULT	1	3	Accelerate	MaxTakeoff	TO		952	98	
DHC6QP	DEFAULT	1	4	Climb	MaxClimb	ZERO	3 000			
DHC6QP	DEFAULT	1	5	Climb	MaxClimb	ZERO	5 500			
DHC6QP	DEFAULT	1	6	Climb	MaxClimb	ZERO	7 500			
DHC6QP	DEFAULT	1	7	Climb	MaxClimb	ZERO	10 000			
DHC7	DEFAULT	1	1	Takeoff	MaxTakeoff	25				
DHC7	DEFAULT	1	2	Climb	MaxTakeoff	25	1 000			

ACFTID	Profile_ID	Stage Length	Step Number	Step Type	Thrust Rating	Flap_ID	End Point Altitude (ft)	Rate Of Climb (ft/min)	End Point CAS (kt)	Accelerate_Percent (%)
DHC7	DEFAULT	1	3	Accelerate	MaxTakeoff	25		933	102	
DHC7	DEFAULT	1	4	Accelerate	MaxTakeoff	10		700	122	
DHC7	DEFAULT	1	5	Climb	MaxClimb	ZERO	3 000			
DHC7	DEFAULT	1	6	Accelerate	MaxClimb	ZERO		700	160	
DHC7	DEFAULT	1	7	Climb	MaxClimb	ZERO	5 500			
DHC7	DEFAULT	1	8	Climb	MaxClimb	ZERO	7 500			
DHC7	DEFAULT	1	9	Climb	MaxClimb	ZERO	10 000			
DHC8	DEFAULT	1	1	Takeoff	MaxTakeoff	15				
DHC8	DEFAULT	1	2	Climb	MaxTakeoff	15	1 000			
DHC8	DEFAULT	1	3	Accelerate	MaxTakeoff	15		1 491	110	
DHC8	DEFAULT	1	4	Accelerate	MaxClimb	5		1 119	125	
DHC8	DEFAULT	1	5	Climb	MaxClimb	ZERO	3 000			
DHC8	DEFAULT	1	6	Accelerate	MaxClimb	ZERO		1 119	165	
DHC8	DEFAULT	1	7	Climb	MaxClimb	ZERO	5 500			
DHC8	DEFAULT	1	8	Climb	MaxClimb	ZERO	7 500			
DHC8	DEFAULT	1	9	Climb	MaxClimb	ZERO	10 000			

Table I-4 (part 4)

Default departures procedural steps

ACFTID	Profile_ID	Stage Length	Step Number	Step Type	Thrust Rating	Flap_ID	End Point Altitude (ft)	Rate Of Climb (ft/min)	End Point CAS (kt)	Accelerate_Percent (%)
DHC830	DEFAULT	1	1	Takeoff	MaxTakeoff	10				
DHC830	DEFAULT	1	2	Climb	MaxTakeoff	10	1 000			
DHC830	DEFAULT	1	3	Accelerate	MaxTakeoff	10		1 280	122	
DHC830	DEFAULT	1	4	Accelerate	MaxClimb	5		960	137	
DHC830	DEFAULT	1	5	Climb	MaxClimb	ZERO	3 000			
DHC830	DEFAULT	1	6	Accelerate	MaxClimb	ZERO		960	179	
DHC830	DEFAULT	1	7	Climb	MaxClimb	ZERO	5 500			
DHC830	DEFAULT	1	8	Climb	MaxClimb	ZERO	7 500			
DHC830	DEFAULT	1	9	Climb	MaxClimb	ZERO	10 000			
DO228	DEFAULT	1	1	Takeoff	MaxTakeoff	FLAPS1				
DO228	DEFAULT	1	2	Accelerate	MaxTakeoff	FLAPS1		1 000	101	
DO228	DEFAULT	1	3	Climb	MaxTakeoff	ZERO	1 000			
DO228	DEFAULT	1	4	Accelerate	MaxClimb	ZERO		1 000	122	
DO228	DEFAULT	1	5	Climb	MaxClimb	ZERO	2 000			
DO228	DEFAULT	1	6	Climb	MaxClimb	ZERO	4 000			
DO228	DEFAULT	1	7	Climb	MaxClimb	ZERO	6 000			
DO228	DEFAULT	1	8	Climb	MaxClimb	ZERO	8 000			
DO228	DEFAULT	1	9	Climb	MaxClimb	ZERO	10 000			
DO328	DEFAULT	1	1	Takeoff	MaxTakeoff	F12-D				
DO328	DEFAULT	1	2	Accelerate	MaxTakeoff	F12-D		1 000	120	

ACFTID	Profile_ID	Stage Length	Step Number	Step Type	Thrust Rating	Flap_ID	End Point Altitude (ft)	Rate Of Climb (ft/min)	End Point CAS (kt)	Accelerate_Percent (%)
DO328	DEFAULT	1	3	Climb	MaxTakeoff	ZERO	1 000			
DO328	DEFAULT	1	4	Accelerate	MaxTakeoff	ZERO		1 000	130	
DO328	DEFAULT	1	5	Climb	MaxClimb	ZERO	2 000			
DO328	DEFAULT	1	6	Climb	MaxClimb	ZERO	4 000			
DO328	DEFAULT	1	7	Climb	MaxClimb	ZERO	6 000			
DO328	DEFAULT	1	8	Climb	MaxClimb	ZERO	8 000			
DO328	DEFAULT	1	9	Climb	MaxClimb	ZERO	10 000			
ECLIPSE500	DEFAULT	1	1	Takeoff	MaxTakeoff	TO_DN				
ECLIPSE500	DEFAULT	1	2	Climb	MaxTakeoff	TO_DN	200			
ECLIPSE500	DEFAULT	1	3	Climb	MaxTakeoff	TO_UP	400			
ECLIPSE500	DEFAULT	1	4	Accelerate	MaxClimb	UP_UP		1 972,9	114	
ECLIPSE500	DEFAULT	1	5	Accelerate	MaxClimb	UP_UP		2 153,3	130,7	
ECLIPSE500	DEFAULT	1	6	Accelerate	MaxClimb	UP_UP		2 276	145,3	
ECLIPSE500	DEFAULT	1	7	Accelerate	MaxClimb	UP_UP		2 313,3	158,2	
ECLIPSE500	DEFAULT	1	8	Accelerate	MaxClimb	UP_UP		2 288,2	170	
ECLIPSE500	DEFAULT	1	9	Climb	Reduce-Climb	UP_UP	6 000			
ECLIPSE500	DEFAULT	1	10	Climb	Reduce-Climb	UP_UP	8 000			
ECLIPSE500	DEFAULT	1	11	Climb	Reduce-Climb	UP_UP	10 000			
ECLIPSE500	DEFAULT	2	1	Takeoff	MaxTakeoff	TO_DN				
ECLIPSE500	DEFAULT	2	2	Climb	MaxTakeoff	TO_DN	200			

ACFTID	Profile_ID	Stage Length	Step Number	Step Type	Thrust Rating	Flap_ID	End Point Altitude (ft)	Rate Of Climb (ft/min)	End Point CAS (kt)	Accelerate_Percent (%)
ECLIPSE500	DEFAULT	2	3	Climb	MaxTakeoff	TO_UP	400			
ECLIPSE500	DEFAULT	2	4	Accelerate	MaxClimb	UP_UP		1 803,3	114,8	
ECLIPSE500	DEFAULT	2	5	Accelerate	MaxClimb	UP_UP		1 971,7	131,2	
ECLIPSE500	DEFAULT	2	6	Accelerate	MaxClimb	UP_UP		2 087,6	145,6	
ECLIPSE500	DEFAULT	2	7	Accelerate	MaxClimb	UP_UP		2 124,1	158,4	
ECLIPSE500	DEFAULT	2	8	Accelerate	MaxClimb	UP_UP		2 102,8	170	
ECLIPSE500	DEFAULT	2	9	Climb	Reduce-Climb	UP_UP	6 000			
ECLIPSE500	DEFAULT	2	10	Climb	Reduce-Climb	UP_UP	8 000			
ECLIPSE500	DEFAULT	2	11	Climb	Reduce-Climb	UP_UP	10 000			
ECLIPSE500	DEFAULT	3	1	Takeoff	MaxTakeoff	TO_DN				
ECLIPSE500	DEFAULT	3	2	Climb	MaxTakeoff	TO_DN	200			
ECLIPSE500	DEFAULT	3	3	Climb	MaxTakeoff	TO_UP	400			
ECLIPSE500	DEFAULT	3	4	Accelerate	MaxClimb	UP_UP		1 760,4	115	
ECLIPSE500	DEFAULT	3	5	Accelerate	MaxClimb	UP_UP		1 926,2	131,4	
ECLIPSE500	DEFAULT	3	6	Accelerate	MaxClimb	UP_UP		2 039,6	145,7	
ECLIPSE500	DEFAULT	3	7	Accelerate	MaxClimb	UP_UP		2 075,3	158,4	
ECLIPSE500	DEFAULT	3	8	Accelerate	MaxClimb	UP_UP		2 054,5	170	
ECLIPSE500	DEFAULT	3	9	Climb	Reduce-Climb	UP_UP	6 000			
ECLIPSE500	DEFAULT	3	10	Climb	Reduce-Climb	UP_UP	8 000			
ECLIPSE500	DEFAULT	3	11	Climb	Reduce-Climb	UP_UP	10 000			

ACFTID	Profile_ID	Stage Length	Step Number	Step Type	Thrust Rating	Flap_ID	End Point Altitude (ft)	Rate Of Climb (ft/min)	End Point CAS (kt)	Accelerate_Percent (%)
ECLIPSE500	HI_ALT	1	1	Takeoff	MaxTakeoff	TO_DN				
ECLIPSE500	HI_ALT	1	2	Climb	MaxTakeoff	TO_DN	200			
ECLIPSE500	HI_ALT	1	3	Climb	MaxTakeoff	TO_UP	400			
ECLIPSE500	HI_ALT	1	4	Accelerate	Reduce-Climb	UP_UP		1 798,3	113,9	
ECLIPSE500	HI_ALT	1	5	Accelerate	Reduce-Climb	UP_UP		1 951,8	130,7	
ECLIPSE500	HI_ALT	1	6	Accelerate	Reduce-Climb	UP_UP		2 043,9	145,3	
ECLIPSE500	HI_ALT	1	7	Accelerate	Reduce-Climb	UP_UP		2 054,7	158,2	
ECLIPSE500	HI_ALT	1	8	Accelerate	Reduce-Climb	UP_UP		1 998,7	170	
ECLIPSE500	HI_ALT	1	9	Climb	Reduce-Climb	UP_UP	6 000			
ECLIPSE500	HI_ALT	1	10	Climb	Reduce-Climb	UP_UP	8 000			
ECLIPSE500	HI_ALT	1	11	Climb	Reduce-Climb	UP_UP	10 000			
ECLIPSE500	HI_ALT	2	1	Takeoff	MaxTakeoff	TO_DN				
ECLIPSE500	HI_ALT	2	2	Climb	MaxTakeoff	TO_DN	200			
ECLIPSE500	HI_ALT	2	3	Climb	MaxTakeoff	TO_UP	400			
ECLIPSE500	HI_ALT	2	4	Accelerate	Reduce-Climb	UP_UP		1 637	114,8	
ECLIPSE500	HI_ALT	2	5	Accelerate	Reduce-Climb	UP_UP		1 780,8	131,2	
ECLIPSE500	HI_ALT	2	6	Accelerate	Reduce-Climb	UP_UP		1 868,3	145,6	
ECLIPSE500	HI_ALT	2	7	Accelerate	Reduce-Climb	UP_UP		1 880,3	158,4	
ECLIPSE500	HI_ALT	2	8	Accelerate	Reduce-Climb	UP_UP		1 838,2	170	
ECLIPSE500	HI_ALT	2	9	Climb	Reduce-Climb	UP_UP	6 000			

ACFTID	Profile_ID	Stage Length	Step Number	Step Type	Thrust Rating	Flap_ID	End Point Altitude (ft)	Rate Of Climb (ft/min)	End Point CAS (kt)	Accelerate_Percent (%)
ECLIPSE500	HI_ALT	2	10	Climb	Reduce-Climb	UP_UP	8 000			
ECLIPSE500	HI_ALT	2	11	Climb	Reduce-Climb	UP_UP	10 000			
ECLIPSE500	HI_ALT	3	1	Takeoff	MaxTakeoff	TO_DN				
ECLIPSE500	HI_ALT	3	2	Climb	MaxTakeoff	TO_DN	200			
ECLIPSE500	HI_ALT	3	3	Climb	MaxTakeoff	TO_UP	400			
ECLIPSE500	HI_ALT	3	4	Accelerate	Reduce-Climb	UP_UP		1 595,5	115	
ECLIPSE500	HI_ALT	3	5	Accelerate	Reduce-Climb	UP_UP		1 736,8	131,4	
ECLIPSE500	HI_ALT	3	6	Accelerate	Reduce-Climb	UP_UP		1 823,1	145,6	
ECLIPSE500	HI_ALT	3	7	Accelerate	Reduce-Climb	UP_UP		1 835,6	158,4	
ECLIPSE500	HI_ALT	3	8	Accelerate	Reduce-Climb	UP_UP		1 794,8	170	
ECLIPSE500	HI_ALT	3	9	Climb	Reduce-Climb	UP_UP	6 000			
ECLIPSE500	HI_ALT	3	10	Climb	Reduce-Climb	UP_UP	8 000			
ECLIPSE500	HI_ALT	3	11	Climb	Reduce-Climb	UP_UP	10 000			
EMB120	DEFAULT	1	1	Takeoff	MaxTakeoff	15				
EMB120	DEFAULT	1	2	Climb	MaxTakeoff	15	1 000			
EMB120	DEFAULT	1	3	Accelerate	MaxTakeoff	15		460	130	
EMB120	DEFAULT	1	4	Accelerate	MaxTakeoff	ZERO		345	135	
EMB120	DEFAULT	1	5	Accelerate	MaxClimb	ZERO		1 000	143	
EMB120	DEFAULT	1	6	Climb	MaxClimb	ZERO	3 000			
EMB120	DEFAULT	1	7	Climb	MaxClimb	ZERO	5 500			

ACFTID	Profile_ID	Stage Length	Step Number	Step Type	Thrust Rating	Flap_ID	End Point Altitude (ft)	Rate Of Climb (ft/min)	End Point CAS (kt)	Accelerate_Percent (%)
EMB120	DEFAULT	1	8	Climb	MaxClimb	ZERO	7 500			
EMB120	DEFAULT	1	9	Climb	MaxClimb	ZERO	10 000			
EMB145	DEFAULT	1	1	Takeoff	MaxTakeoff	9-GEAR				
EMB145	DEFAULT	1	2	Climb	MaxTakeoff	9	1 000			
EMB145	DEFAULT	1	3	Accelerate	MaxClimb	ZERO		1 367	220	
EMB145	DEFAULT	1	4	Climb	MaxClimb	ZERO	3 000			
EMB145	DEFAULT	1	5	Accelerate	MaxClimb	ZERO		1 000	250	
EMB145	DEFAULT	1	6	Climb	MaxClimb	ZERO	5 500			
EMB145	DEFAULT	1	7	Climb	MaxClimb	ZERO	7 500			
EMB145	DEFAULT	1	8	Climb	MaxClimb	ZERO	10 000			
EMB145	DEFAULT	2	1	Takeoff	MaxTakeoff	9-GEAR				
EMB145	DEFAULT	2	2	Climb	MaxTakeoff	9	1 000			
EMB145	DEFAULT	2	3	Accelerate	MaxClimb	ZERO		1 334	220	
EMB145	DEFAULT	2	4	Climb	MaxClimb	ZERO	3 000			
EMB145	DEFAULT	2	5	Accelerate	MaxClimb	ZERO		1 000	250	
EMB145	DEFAULT	2	6	Climb	MaxClimb	ZERO	5 500			
EMB145	DEFAULT	2	7	Climb	MaxClimb	ZERO	7 500			
EMB145	DEFAULT	2	8	Climb	MaxClimb	ZERO	10 000			
EMB145	DEFAULT	3	1	Takeoff	MaxTakeoff	9-GEAR				
EMB145	DEFAULT	3	2	Climb	MaxTakeoff	9	1 000			

ACFTID	Profile_ID	Stage Length	Step Number	Step Type	Thrust Rating	Flap_ID	End Point Altitude (ft)	Rate Of Climb (ft/min)	End Point CAS (kt)	Accelerate_Percent (%)
EMB145	DEFAULT	3	3	Accelerate	MaxClimb	ZERO		1 315	220	
EMB145	DEFAULT	3	4	Climb	MaxClimb	ZERO	3 000			
EMB145	DEFAULT	3	5	Accelerate	MaxClimb	ZERO		1 000	250	
EMB145	DEFAULT	3	6	Climb	MaxClimb	ZERO	5 500			
EMB145	DEFAULT	3	7	Climb	MaxClimb	ZERO	7 500			
EMB145	DEFAULT	3	8	Climb	MaxClimb	ZERO	10 000			
EMB145	DEFAULT	4	1	Takeoff	MaxTakeoff	9-GEAR				
EMB145	DEFAULT	4	2	Climb	MaxTakeoff	9	1 000			
EMB145	DEFAULT	4	3	Accelerate	MaxClimb	ZERO		1 293	220	
EMB145	DEFAULT	4	4	Climb	MaxClimb	ZERO	3 200			
EMB145	DEFAULT	4	5	Accelerate	MaxClimb	ZERO		1 000	250	
EMB145	DEFAULT	4	6	Climb	MaxClimb	ZERO	5 500			
EMB145	DEFAULT	4	7	Climb	MaxClimb	ZERO	7 500			
EMB145	DEFAULT	4	8	Climb	MaxClimb	ZERO	10 000			
EMB14L	DEFAULT	1	1	Takeoff	MaxTakeoff	9-GEAR				
EMB14L	DEFAULT	1	2	Climb	MaxTakeoff	9	1 000			
EMB14L	DEFAULT	1	3	Accelerate	MaxClimb	ZERO		1 465	220	
EMB14L	DEFAULT	1	4	Climb	MaxClimb	ZERO	3 000			
EMB14L	DEFAULT	1	5	Accelerate	MaxClimb	ZERO		1 000	250	
EMB14L	DEFAULT	1	6	Climb	MaxClimb	ZERO	5 500			

ACFTID	Profile_ID	Stage Length	Step Number	Step Type	Thrust Rating	Flap_ID	End Point Altitude (ft)	Rate Of Climb (ft/min)	End Point CAS (kt)	Accelerate_Percent (%)
EMB14L	DEFAULT	1	7	Climb	MaxClimb	ZERO	7 500			
EMB14L	DEFAULT	1	8	Climb	MaxClimb	ZERO	10 000			
EMB14L	DEFAULT	2	1	Takeoff	MaxTakeoff	9-GEAR				
EMB14L	DEFAULT	2	2	Climb	MaxTakeoff	9	1 000			
EMB14L	DEFAULT	2	3	Accelerate	MaxClimb	ZERO		1 420	220	
EMB14L	DEFAULT	2	4	Climb	MaxClimb	ZERO	3 000			
EMB14L	DEFAULT	2	5	Accelerate	MaxClimb	ZERO		1 000	250	
EMB14L	DEFAULT	2	6	Climb	MaxClimb	ZERO	5 500			
EMB14L	DEFAULT	2	7	Climb	MaxClimb	ZERO	7 500			
EMB14L	DEFAULT	2	8	Climb	MaxClimb	ZERO	10 000			
EMB14L	DEFAULT	3	1	Takeoff	MaxTakeoff	9-GEAR				
EMB14L	DEFAULT	3	2	Climb	MaxTakeoff	9	1 000			
EMB14L	DEFAULT	3	3	Accelerate	MaxClimb	ZERO		1 395	220	
EMB14L	DEFAULT	3	4	Climb	MaxClimb	ZERO	3 000			
EMB14L	DEFAULT	3	5	Accelerate	MaxClimb	ZERO		1 000	250	
EMB14L	DEFAULT	3	6	Climb	MaxClimb	ZERO	5 500			
EMB14L	DEFAULT	3	7	Climb	MaxClimb	ZERO	7 500			
EMB14L	DEFAULT	3	8	Climb	MaxClimb	ZERO	10 000			
EMB14L	DEFAULT	4	1	Takeoff	MaxTakeoff	9-GEAR				
EMB14L	DEFAULT	4	2	Climb	MaxTakeoff	9	1 000			

ACFTID	Profile_ID	Stage Length	Step Number	Step Type	Thrust Rating	Flap_ID	End Point Altitude (ft)	Rate Of Climb (ft/min)	End Point CAS (kt)	Accelerate_Percent (%)
EMB14L	DEFAULT	4	3	Accelerate	MaxClimb	ZERO		1 366	220	
EMB14L	DEFAULT	4	4	Climb	MaxClimb	ZERO	3 000			
EMB14L	DEFAULT	4	5	Accelerate	MaxClimb	ZERO		1 000	250	
EMB14L	DEFAULT	4	6	Climb	MaxClimb	ZERO	5 500			
EMB14L	DEFAULT	4	7	Climb	MaxClimb	ZERO	7 500			
EMB14L	DEFAULT	4	8	Climb	MaxClimb	ZERO	10 000			
EMB14L	DEFAULT	5	1	Takeoff	MaxTakeoff	9-GEAR				
EMB14L	DEFAULT	5	2	Climb	MaxTakeoff	9	1 000			
EMB14L	DEFAULT	5	3	Accelerate	MaxClimb	ZERO		1 335	220	
EMB14L	DEFAULT	5	4	Climb	MaxClimb	ZERO	3 000			
EMB14L	DEFAULT	5	5	Accelerate	MaxClimb	ZERO		1 000	250	
EMB14L	DEFAULT	5	6	Climb	MaxClimb	ZERO	5 500			
EMB14L	DEFAULT	5	7	Climb	MaxClimb	ZERO	7 500			
EMB14L	DEFAULT	5	8	Climb	MaxClimb	ZERO	10 000			
EMB14L	DEFAULT	6	1	Takeoff	MaxTakeoff	9-GEAR				
EMB14L	DEFAULT	6	2	Climb	MaxTakeoff	9	1 000			
EMB14L	DEFAULT	6	3	Accelerate	MaxClimb	ZERO		1 298	220	
EMB14L	DEFAULT	6	4	Climb	MaxClimb	ZERO	3 000			
EMB14L	DEFAULT	6	5	Accelerate	MaxClimb	ZERO		1 000	250	
EMB14L	DEFAULT	6	6	Climb	MaxClimb	ZERO	5 500			

ACFTID	Profile_ID	Stage Length	Step Number	Step Type	Thrust Rating	Flap_ID	End Point Altitude (ft)	Rate Of Climb (ft/min)	End Point CAS (kt)	Accelerate_Percent (%)
EMB14L	DEFAULT	6	7	Climb	MaxClimb	ZERO	7 500			
EMB14L	DEFAULT	6	8	Climb	MaxClimb	ZERO	10 000			
EMB170	DEFAULT	1	1	Takeoff	MaxTakeoff	1				
EMB170	DEFAULT	1	2	Climb	MaxTakeoff	1	1 000			
EMB170	DEFAULT	1	3	Accelerate	MaxClimb	ZERO		1 936	196	
EMB170	DEFAULT	1	4	Climb	MaxClimb	ZERO	3 000			
EMB170	DEFAULT	1	5	Accelerate	MaxClimb	ZERO		2 339	240	
EMB170	DEFAULT	1	6	Climb	MaxClimb	ZERO	5 500			
EMB170	DEFAULT	1	7	Climb	MaxClimb	ZERO	7 500			
EMB170	DEFAULT	1	8	Climb	MaxClimb	ZERO	10 000			
EMB170	DEFAULT	2	1	Takeoff	MaxTakeoff	1				
EMB170	DEFAULT	2	2	Climb	MaxTakeoff	1	1 000			
EMB170	DEFAULT	2	3	Accelerate	MaxClimb	ZERO		1 836	197,1	
EMB170	DEFAULT	2	4	Climb	MaxClimb	ZERO	3 000			
EMB170	DEFAULT	2	5	Accelerate	MaxClimb	ZERO		2 228	240	
EMB170	DEFAULT	2	6	Climb	MaxClimb	ZERO	5 500			
EMB170	DEFAULT	2	7	Climb	MaxClimb	ZERO	7 500			
EMB170	DEFAULT	2	8	Climb	MaxClimb	ZERO	10 000			
EMB170	DEFAULT	3	1	Takeoff	MaxTakeoff	1				
EMB170	DEFAULT	3	2	Climb	MaxTakeoff	1	1 000			

ACFTID	Profile_ID	Stage Length	Step Number	Step Type	Thrust Rating	Flap_ID	End Point Altitude (ft)	Rate Of Climb (ft/min)	End Point CAS (kt)	Accelerate_Percent (%)
EMB170	DEFAULT	3	3	Accelerate	MaxClimb	ZERO		1 772	200,9	
EMB170	DEFAULT	3	4	Climb	MaxClimb	ZERO	3 000			
EMB170	DEFAULT	3	5	Accelerate	MaxClimb	ZERO		2 120	240	
EMB170	DEFAULT	3	6	Climb	MaxClimb	ZERO	5 500			
EMB170	DEFAULT	3	7	Climb	MaxClimb	ZERO	7 500			
EMB170	DEFAULT	3	8	Climb	MaxClimb	ZERO	10 000			
EMB170	ICAO_A	1	1	Takeoff	MaxTakeoff	1				
EMB170	ICAO_A	1	2	Climb	MaxTakeoff	1	1 500			
EMB170	ICAO_A	1	3	Climb	MaxClimb	1	3 000			
EMB170	ICAO_A	1	4	Accelerate	MaxClimb	ZERO		1 650	195	
EMB170	ICAO_A	1	5	Accelerate	MaxClimb	ZERO		2 035	240	
EMB170	ICAO_A	1	6	Climb	MaxClimb	ZERO	5 500			
EMB170	ICAO_A	1	7	Climb	MaxClimb	ZERO	7 500			
EMB170	ICAO_A	1	8	Climb	MaxClimb	ZERO	10 000			
EMB170	ICAO_A	2	1	Takeoff	MaxTakeoff	1				
EMB170	ICAO_A	2	2	Climb	MaxTakeoff	1	1 500			
EMB170	ICAO_A	2	3	Climb	MaxClimb	1	3 000			
EMB170	ICAO_A	2	4	Accelerate	MaxClimb	ZERO		1 617	198,1	
EMB170	ICAO_A	2	5	Accelerate	MaxClimb	ZERO		1 944	240	
EMB170	ICAO_A	2	6	Climb	MaxClimb	ZERO	5 500			

ACFTID	Profile_ID	Stage Length	Step Number	Step Type	Thrust Rating	Flap_ID	End Point Altitude (ft)	Rate Of Climb (ft/min)	End Point CAS (kt)	Accelerate_Percent (%)
EMB170	ICAO_A	2	7	Climb	MaxClimb	ZERO	7 500			
EMB170	ICAO_A	2	8	Climb	MaxClimb	ZERO	10 000			
EMB170	ICAO_A	3	1	Takeoff	MaxTakeoff	1				
EMB170	ICAO_A	3	2	Climb	MaxTakeoff	1	1 500			
EMB170	ICAO_A	3	3	Climb	MaxClimb	1	3 000			
EMB170	ICAO_A	3	4	Accelerate	MaxClimb	ZERO		1 546	200,4	
EMB170	ICAO_A	3	5	Accelerate	MaxClimb	ZERO		1 850	240	
EMB170	ICAO_A	3	6	Climb	MaxClimb	ZERO	5 500			
EMB170	ICAO_A	3	7	Climb	MaxClimb	ZERO	7 500			
EMB170	ICAO_A	3	8	Climb	MaxClimb	ZERO	10 000			
EMB170	ICAO_B	1	1	Takeoff	MaxTakeoff	1				
EMB170	ICAO_B	1	2	Climb	MaxTakeoff	1	1 000			
EMB170	ICAO_B	1	3	Accelerate	MaxTakeoff	ZERO		1 899	195,5	
EMB170	ICAO_B	1	4	Climb	MaxClimb	ZERO	3 000			
EMB170	ICAO_B	1	5	Accelerate	MaxClimb	ZERO		2 301	240	
EMB170	ICAO_B	1	6	Climb	MaxClimb	ZERO	5 500			
EMB170	ICAO_B	1	7	Climb	MaxClimb	ZERO	7 500			
EMB170	ICAO_B	1	8	Climb	MaxClimb	ZERO	10 000			
EMB170	ICAO_B	2	1	Takeoff	MaxTakeoff	1				
EMB170	ICAO_B	2	2	Climb	MaxTakeoff	1	1 000			

ACFTID	Profile_ID	Stage Length	Step Number	Step Type	Thrust Rating	Flap_ID	End Point Altitude (ft)	Rate Of Climb (ft/min)	End Point CAS (kt)	Accelerate_Percent (%)
EMB170	ICAO_B	2	3	Accelerate	MaxTakeoff	ZERO		1 823	198,2	
EMB170	ICAO_B	2	4	Climb	MaxClimb	ZERO	3 000			
EMB170	ICAO_B	2	5	Accelerate	MaxClimb	ZERO		2 195	240	
EMB170	ICAO_B	2	6	Climb	MaxClimb	ZERO	5 500			
EMB170	ICAO_B	2	7	Climb	MaxClimb	ZERO	7 500			
EMB170	ICAO_B	2	8	Climb	MaxClimb	ZERO	10 000			
EMB170	ICAO_B	3	1	Takeoff	MaxTakeoff	1				
EMB170	ICAO_B	3	2	Climb	MaxTakeoff	1	1 000			
EMB170	ICAO_B	3	3	Accelerate	MaxTakeoff	ZERO		1 743	201	
EMB170	ICAO_B	3	4	Climb	MaxClimb	ZERO	3 000			
EMB170	ICAO_B	3	5	Accelerate	MaxClimb	ZERO		2 085	240	
EMB170	ICAO_B	3	6	Climb	MaxClimb	ZERO	5 500			
EMB170	ICAO_B	3	7	Climb	MaxClimb	ZERO	7 500			
EMB170	ICAO_B	3	8	Climb	MaxClimb	ZERO	10 000			
EMB175	DEFAULT	1	1	Takeoff	MaxTakeoff	1				
EMB175	DEFAULT	1	2	Climb	MaxTakeoff	1	1 000			
EMB175	DEFAULT	1	3	Accelerate	MaxClimb	ZERO		1 900	196	
EMB175	DEFAULT	1	4	Climb	MaxClimb	ZERO	3 000			
EMB175	DEFAULT	1	5	Accelerate	MaxClimb	ZERO		2 308	240	
EMB175	DEFAULT	1	6	Climb	MaxClimb	ZERO	5 500			

ACFTID	Profile_ID	Stage Length	Step Number	Step Type	Thrust Rating	Flap_ID	End Point Altitude (ft)	Rate Of Climb (ft/min)	End Point CAS (kt)	Accelerate_Percent (%)
EMB175	DEFAULT	1	7	Climb	MaxClimb	ZERO	7 500			
EMB175	DEFAULT	1	8	Climb	MaxClimb	ZERO	10 000			
EMB175	DEFAULT	2	1	Takeoff	MaxTakeoff	1				
EMB175	DEFAULT	2	2	Climb	MaxTakeoff	1	1 000			
EMB175	DEFAULT	2	3	Accelerate	MaxClimb	ZERO		1 823	198,1	
EMB175	DEFAULT	2	4	Climb	MaxClimb	ZERO	3 000			
EMB175	DEFAULT	2	5	Accelerate	MaxClimb	ZERO		2 190	240	
EMB175	DEFAULT	2	6	Climb	MaxClimb	ZERO	5 500			
EMB175	DEFAULT	2	7	Climb	MaxClimb	ZERO	7 500			
EMB175	DEFAULT	2	8	Climb	MaxClimb	ZERO	10 000			
EMB175	DEFAULT	3	1	Takeoff	MaxTakeoff	1				
EMB175	DEFAULT	3	2	Climb	MaxTakeoff	1	1 000			
EMB175	DEFAULT	3	3	Accelerate	MaxClimb	ZERO		1 745	200,3	
EMB175	DEFAULT	3	4	Climb	MaxClimb	ZERO	3 000			
EMB175	DEFAULT	3	5	Accelerate	MaxClimb	ZERO		2 086	240	
EMB175	DEFAULT	3	6	Climb	MaxClimb	ZERO	5 500			
EMB175	DEFAULT	3	7	Climb	MaxClimb	ZERO	7 500			
EMB175	DEFAULT	3	8	Climb	MaxClimb	ZERO	10 000			
EMB175	ICAO_A	1	1	Takeoff	MaxTakeoff	1				
EMB175	ICAO_A	1	2	Climb	MaxTakeoff	1	1 500			

ACFTID	Profile_ID	Stage Length	Step Number	Step Type	Thrust Rating	Flap_ID	End Point Altitude (ft)	Rate Of Climb (ft/min)	End Point CAS (kt)	Accelerate_Percent (%)
EMB175	ICAO_A	1	3	Climb	MaxClimb	1	3 000			
EMB175	ICAO_A	1	4	Accelerate	MaxClimb	ZERO		1 634	195	
EMB175	ICAO_A	1	5	Accelerate	MaxClimb	ZERO		1 979	240	
EMB175	ICAO_A	1	6	Climb	MaxClimb	ZERO	5 500			
EMB175	ICAO_A	1	7	Climb	MaxClimb	ZERO	7 500			
EMB175	ICAO_A	1	8	Climb	MaxClimb	ZERO	10 000			
EMB175	ICAO_A	2	1	Takeoff	MaxTakeoff	1				
EMB175	ICAO_A	2	2	Climb	MaxTakeoff	1	1 500			
EMB175	ICAO_A	2	3	Climb	MaxClimb	1	3 000			
EMB175	ICAO_A	2	4	Accelerate	MaxClimb	ZERO		1 568	198,5	
EMB175	ICAO_A	2	5	Accelerate	MaxClimb	ZERO		1 885	240	
EMB175	ICAO_A	2	6	Climb	MaxClimb	ZERO	5 500			
EMB175	ICAO_A	2	7	Climb	MaxClimb	ZERO	7 500			
EMB175	ICAO_A	2	8	Climb	MaxClimb	ZERO	10 000			
EMB175	ICAO_A	3	1	Takeoff	MaxTakeoff	1				
EMB175	ICAO_A	3	2	Climb	MaxTakeoff	1	1 500			
EMB175	ICAO_A	3	3	Climb	MaxClimb	1	3 000			
EMB175	ICAO_A	3	4	Accelerate	MaxClimb	ZERO		1 499	201,3	
EMB175	ICAO_A	3	5	Accelerate	MaxClimb	ZERO		1 794	240	
EMB175	ICAO_A	3	6	Climb	MaxClimb	ZERO	5 500			

ACFTID	Profile_ID	Stage Length	Step Number	Step Type	Thrust Rating	Flap_ID	End Point Altitude (ft)	Rate Of Climb (ft/min)	End Point CAS (kt)	Accelerate_Percent (%)
EMB175	ICAO_A	3	7	Climb	MaxClimb	ZERO	7 500			
EMB175	ICAO_A	3	8	Climb	MaxClimb	ZERO	10 000			
EMB175	ICAO_B	1	1	Takeoff	MaxTakeoff	1				
EMB175	ICAO_B	1	2	Climb	MaxTakeoff	1	1 000			
EMB175	ICAO_B	1	3	Accelerate	MaxTakeoff	ZERO		1 818	195,5	
EMB175	ICAO_B	1	4	Climb	MaxClimb	ZERO	3 000			
EMB175	ICAO_B	1	5	Accelerate	MaxClimb	ZERO		2 202	240	
EMB175	ICAO_B	1	6	Climb	MaxClimb	ZERO	5 500			
EMB175	ICAO_B	1	7	Climb	MaxClimb	ZERO	7 500			
EMB175	ICAO_B	1	8	Climb	MaxClimb	ZERO	10 000			
EMB175	ICAO_B	2	1	Takeoff	MaxTakeoff	1				
EMB175	ICAO_B	2	2	Climb	MaxTakeoff	1	1 000			
EMB175	ICAO_B	2	3	Accelerate	MaxTakeoff	ZERO		1 744	197,1	
EMB175	ICAO_B	2	4	Climb	MaxClimb	ZERO	3 000			
EMB175	ICAO_B	2	5	Accelerate	MaxClimb	ZERO		2 099	240	
EMB175	ICAO_B	2	6	Climb	MaxClimb	ZERO	5 500			
EMB175	ICAO_B	2	7	Climb	MaxClimb	ZERO	7 500			
EMB175	ICAO_B	2	8	Climb	MaxClimb	ZERO	10 000			
EMB175	ICAO_B	3	1	Takeoff	MaxTakeoff	1				
EMB175	ICAO_B	3	2	Climb	MaxTakeoff	1	1 000			

ACFTID	Profile_ID	Stage Length	Step Number	Step Type	Thrust Rating	Flap_ID	End Point Altitude (ft)	Rate Of Climb (ft/min)	End Point CAS (kt)	Accelerate_Percent (%)
EMB175	ICAO_B	3	3	Accelerate	MaxTakeoff	ZERO		1 668	200,8	
EMB175	ICAO_B	3	4	Climb	MaxClimb	ZERO	3 000			
EMB175	ICAO_B	3	5	Accelerate	MaxClimb	ZERO		1 996	240	
EMB175	ICAO_B	3	6	Climb	MaxClimb	ZERO	5 500			
EMB175	ICAO_B	3	7	Climb	MaxClimb	ZERO	7 500			
EMB175	ICAO_B	3	8	Climb	MaxClimb	ZERO	10 000			
EMB190	DEFAULT	1	1	Takeoff	MaxTakeoff	1				
EMB190	DEFAULT	1	2	Climb	MaxTakeoff	1	1 000			
EMB190	DEFAULT	1	3	Accelerate	MaxClimb	ZERO		1 685	194,5	
EMB190	DEFAULT	1	4	Climb	MaxClimb	ZERO	3 000			
EMB190	DEFAULT	1	5	Accelerate	MaxClimb	ZERO		2 041	250	
EMB190	DEFAULT	1	6	Climb	MaxClimb	ZERO	5 500			
EMB190	DEFAULT	1	7	Climb	MaxClimb	ZERO	7 500			
EMB190	DEFAULT	1	8	Climb	MaxClimb	ZERO	10 000			
EMB190	DEFAULT	2	1	Takeoff	MaxTakeoff	1				
EMB190	DEFAULT	2	2	Climb	MaxTakeoff	1	1 000			
EMB190	DEFAULT	2	3	Accelerate	MaxClimb	ZERO		1 616	197,1	
EMB190	DEFAULT	2	4	Climb	MaxClimb	ZERO	3 000			
EMB190	DEFAULT	2	5	Accelerate	MaxClimb	ZERO		1 944	250	
EMB190	DEFAULT	2	6	Climb	MaxClimb	ZERO	5 500			

ACFTID	Profile_ID	Stage Length	Step Number	Step Type	Thrust Rating	Flap_ID	End Point Altitude (ft)	Rate Of Climb (ft/min)	End Point CAS (kt)	Accelerate_Percent (%)
EMB190	DEFAULT	2	7	Climb	MaxClimb	ZERO	7 500			
EMB190	DEFAULT	2	8	Climb	MaxClimb	ZERO	10 000			
EMB190	DEFAULT	3	1	Takeoff	MaxTakeoff	1				
EMB190	DEFAULT	3	2	Climb	MaxTakeoff	1	1 000			
EMB190	DEFAULT	3	3	Accelerate	MaxClimb	ZERO		1 546	199,7	
EMB190	DEFAULT	3	4	Climb	MaxClimb	ZERO	3 000			
EMB190	DEFAULT	3	5	Accelerate	MaxClimb	ZERO		1 850	250	
EMB190	DEFAULT	3	6	Climb	MaxClimb	ZERO	5 500			
EMB190	DEFAULT	3	7	Climb	MaxClimb	ZERO	7 500			
EMB190	DEFAULT	3	8	Climb	MaxClimb	ZERO	10 000			
EMB190	DEFAULT	4	1	Takeoff	MaxTakeoff	1				
EMB190	DEFAULT	4	2	Climb	MaxTakeoff	1	1 000			
EMB190	DEFAULT	4	3	Accelerate	MaxClimb	ZERO		1 416	205,2	
EMB190	DEFAULT	4	4	Climb	MaxClimb	ZERO	3 000			
EMB190	DEFAULT	4	5	Accelerate	MaxClimb	ZERO		1 677	250	
EMB190	DEFAULT	4	6	Climb	MaxClimb	ZERO	5 500			
EMB190	DEFAULT	4	7	Climb	MaxClimb	ZERO	7 500			
EMB190	DEFAULT	4	8	Climb	MaxClimb	ZERO	10 000			
EMB190	ICAO_A	1	1	Takeoff	MaxTakeoff	1				
EMB190	ICAO_A	1	2	Climb	MaxTakeoff	1	1 500			

ACFTID	Profile_ID	Stage Length	Step Number	Step Type	Thrust Rating	Flap_ID	End Point Altitude (ft)	Rate Of Climb (ft/min)	End Point CAS (kt)	Accelerate_Percent (%)
EMB190	ICAO_A	1	3	Climb	MaxClimb	1	3 000			
EMB190	ICAO_A	1	4	Accelerate	MaxClimb	ZERO		1 652	194,1	
EMB190	ICAO_A	1	5	Accelerate	MaxClimb	ZERO		2 012	250	
EMB190	ICAO_A	1	6	Climb	MaxClimb	ZERO	5 500			
EMB190	ICAO_A	1	7	Climb	MaxClimb	ZERO	7 500			
EMB190	ICAO_A	1	8	Climb	MaxClimb	ZERO	10 000			
EMB190	ICAO_A	2	1	Takeoff	MaxTakeoff	1				
EMB190	ICAO_A	2	2	Climb	MaxTakeoff	1	1 500			
EMB190	ICAO_A	2	3	Climb	MaxClimb	1	3 000			
EMB190	ICAO_A	2	4	Accelerate	MaxClimb	ZERO		1 582	196,6	
EMB190	ICAO_A	2	5	Accelerate	MaxClimb	ZERO		1 918	250	
EMB190	ICAO_A	2	6	Climb	MaxClimb	ZERO	5 500			
EMB190	ICAO_A	2	7	Climb	MaxClimb	ZERO	7 500			
EMB190	ICAO_A	2	8	Climb	MaxClimb	ZERO	10 000			
EMB190	ICAO_A	3	1	Takeoff	MaxTakeoff	1				
EMB190	ICAO_A	3	2	Climb	MaxTakeoff	1	1 500			
EMB190	ICAO_A	3	3	Climb	MaxClimb	1	3 000			
EMB190	ICAO_A	3	4	Accelerate	MaxClimb	ZERO		1 513	199,4	
EMB190	ICAO_A	3	5	Accelerate	MaxClimb	ZERO		1 826	250	
EMB190	ICAO_A	3	6	Climb	MaxClimb	ZERO	5 500			

ACFTID	Profile_ID	Stage Length	Step Number	Step Type	Thrust Rating	Flap_ID	End Point Altitude (ft)	Rate Of Climb (ft/min)	End Point CAS (kt)	Accelerate_Percent (%)
EMB190	ICAO_A	3	7	Climb	MaxClimb	ZERO	7 500			
EMB190	ICAO_A	3	8	Climb	MaxClimb	ZERO	10 000			
EMB190	ICAO_A	4	1	Takeoff	MaxTakeoff	1				
EMB190	ICAO_A	4	2	Climb	MaxTakeoff	1	1 500			
EMB190	ICAO_A	4	3	Climb	MaxClimb	1	3 000			
EMB190	ICAO_A	4	4	Accelerate	MaxClimb	ZERO		1 382	204,8	
EMB190	ICAO_A	4	5	Accelerate	MaxClimb	ZERO		1 658	250	
EMB190	ICAO_A	4	6	Climb	MaxClimb	ZERO	7 500			
EMB190	ICAO_A	4	7	Climb	MaxClimb	ZERO	10 000			
EMB190	ICAO_B	1	1	Takeoff	MaxTakeoff	1				
EMB190	ICAO_B	1	2	Climb	MaxTakeoff	1	1 000			
EMB190	ICAO_B	1	3	Accelerate	MaxTakeoff	ZERO		1 899	194,4	
EMB190	ICAO_B	1	4	Climb	MaxClimb	ZERO	3 000			
EMB190	ICAO_B	1	5	Accelerate	MaxClimb	ZERO		2 171	250	
EMB190	ICAO_B	1	6	Climb	MaxClimb	ZERO	5 500			
EMB190	ICAO_B	1	7	Climb	MaxClimb	ZERO	7 500			
EMB190	ICAO_B	1	8	Climb	MaxClimb	ZERO	10 000			
EMB190	ICAO_B	2	1	Takeoff	MaxTakeoff	1				
EMB190	ICAO_B	2	2	Climb	MaxTakeoff	1	1 000			
EMB190	ICAO_B	2	3	Accelerate	MaxTakeoff	ZERO		1 824	197	

ACFTID	Profile_ID	Stage Length	Step Number	Step Type	Thrust Rating	Flap_ID	End Point Altitude (ft)	Rate Of Climb (ft/min)	End Point CAS (kt)	Accelerate_Percent (%)
EMB190	ICAO_B	2	4	Climb	MaxClimb	ZERO	3 000			
EMB190	ICAO_B	2	5	Accelerate	MaxClimb	ZERO		2 069	250	
EMB190	ICAO_B	2	6	Climb	MaxClimb	ZERO	5 500			
EMB190	ICAO_B	2	7	Climb	MaxClimb	ZERO	7 500			
EMB190	ICAO_B	2	8	Climb	MaxClimb	ZERO	10 000			
EMB190	ICAO_B	3	1	Takeoff	MaxTakeoff	1				
EMB190	ICAO_B	3	2	Climb	MaxTakeoff	1	1 000			
EMB190	ICAO_B	3	3	Accelerate	MaxTakeoff	ZERO		1 628	199,7	
EMB190	ICAO_B	3	4	Climb	MaxClimb	ZERO	3 000			
EMB190	ICAO_B	3	5	Accelerate	MaxClimb	ZERO		1 969	250	
EMB190	ICAO_B	3	6	Climb	MaxClimb	ZERO	5 500			
EMB190	ICAO_B	3	7	Climb	MaxClimb	ZERO	7 500			
EMB190	ICAO_B	3	8	Climb	MaxClimb	ZERO	10 000			
EMB190	ICAO_B	4	1	Takeoff	MaxTakeoff	1				
EMB190	ICAO_B	4	2	Climb	MaxTakeoff	1	1 000			
EMB190	ICAO_B	4	3	Accelerate	MaxTakeoff	ZERO		1 603	205,1	
EMB190	ICAO_B	4	4	Climb	MaxClimb	ZERO	3 000			
EMB190	ICAO_B	4	5	Accelerate	MaxClimb	ZERO		1 784	250	
EMB190	ICAO_B	4	6	Climb	MaxClimb	ZERO	5 500			
EMB190	ICAO_B	4	7	Climb	MaxClimb	ZERO	7 500			

ACFTID	Profile_ID	Stage Length	Step Number	Step Type	Thrust Rating	Flap_ID	End Point Altitude (ft)	Rate Of Climb (ft/min)	End Point CAS (kt)	Accelerate_Percent (%)
EMB190	ICAO_B	4	8	Climb	MaxClimb	ZERO	10 000			
EMB195	DEFAULT	1	1	Takeoff	MaxTakeoff	1				
EMB195	DEFAULT	1	2	Climb	MaxTakeoff	1	1 000			
EMB195	DEFAULT	1	3	Accelerate	MaxClimb	ZERO		1 622	195	
EMB195	DEFAULT	1	4	Climb	MaxClimb	ZERO	3 000			
EMB195	DEFAULT	1	5	Accelerate	MaxClimb	ZERO		1 965	250	
EMB195	DEFAULT	1	6	Climb	MaxClimb	ZERO	5 500			
EMB195	DEFAULT	1	7	Climb	MaxClimb	ZERO	7 500			
EMB195	DEFAULT	1	8	Climb	MaxClimb	ZERO	10 000			
EMB195	DEFAULT	2	1	Takeoff	MaxTakeoff	1				
EMB195	DEFAULT	2	2	Climb	MaxTakeoff	1	1 000			
EMB195	DEFAULT	2	3	Accelerate	MaxClimb	ZERO		1 556	197,6	
EMB195	DEFAULT	2	4	Climb	MaxClimb	ZERO	3 000			
EMB195	DEFAULT	2	5	Accelerate	MaxClimb	ZERO		1 872	250	
EMB195	DEFAULT	2	6	Climb	MaxClimb	ZERO	5 500			
EMB195	DEFAULT	2	7	Climb	MaxClimb	ZERO	7 500			
EMB195	DEFAULT	2	8	Climb	MaxClimb	ZERO	10 000			
EMB195	DEFAULT	3	1	Takeoff	MaxTakeoff	1				
EMB195	DEFAULT	3	2	Climb	MaxTakeoff	1	1 000			
EMB195	DEFAULT	3	3	Accelerate	MaxClimb	ZERO		1 489	200,2	

ACFTID	Profile_ID	Stage Length	Step Number	Step Type	Thrust Rating	Flap_ID	End Point Altitude (ft)	Rate Of Climb (ft/min)	End Point CAS (kt)	Accelerate_Percent (%)
EMB195	DEFAULT	3	4	Climb	MaxClimb	ZERO	3 000			
EMB195	DEFAULT	3	5	Accelerate	MaxClimb	ZERO		1 781	250	
EMB195	DEFAULT	3	6	Climb	MaxClimb	ZERO	5 500			
EMB195	DEFAULT	3	7	Climb	MaxClimb	ZERO	7 500			
EMB195	DEFAULT	3	8	Climb	MaxClimb	ZERO	10 000			
EMB195	DEFAULT	4	1	Takeoff	MaxTakeoff	1				
EMB195	DEFAULT	4	2	Climb	MaxTakeoff	1	1 000			
EMB195	DEFAULT	4	3	Accelerate	MaxClimb	ZERO		1 364	205,7	
EMB195	DEFAULT	4	4	Climb	MaxClimb	ZERO	3 000			
EMB195	DEFAULT	4	5	Accelerate	MaxClimb	ZERO		1 615	250	
EMB195	DEFAULT	4	6	Climb	MaxClimb	ZERO	7 500			
EMB195	DEFAULT	4	7	Climb	MaxClimb	ZERO	10 000			
EMB195	ICAO_A	1	1	Takeoff	MaxTakeoff	1				
EMB195	ICAO_A	1	2	Climb	MaxTakeoff	1	1 500			
EMB195	ICAO_A	1	3	Climb	MaxClimb	1	3 000			
EMB195	ICAO_A	1	4	Accelerate	MaxClimb	ZERO		1 605	196,5	
EMB195	ICAO_A	1	5	Accelerate	MaxClimb	ZERO		1 930	250	
EMB195	ICAO_A	1	6	Climb	MaxClimb	ZERO	7 500			
EMB195	ICAO_A	1	7	Climb	MaxClimb	ZERO	10 000			
EMB195	ICAO_A	2	1	Takeoff	MaxTakeoff	1				

ACFTID	Profile_ID	Stage Length	Step Number	Step Type	Thrust Rating	Flap_ID	End Point Altitude (ft)	Rate Of Climb (ft/min)	End Point CAS (kt)	Accelerate_Percent (%)
EMB195	ICAO_A	2	2	Climb	MaxTakeoff	1	1 500			
EMB195	ICAO_A	2	3	Climb	MaxClimb	1	3 000			
EMB195	ICAO_A	2	4	Accelerate	MaxClimb	ZERO		1 538	198,1	
EMB195	ICAO_A	2	5	Accelerate	MaxClimb	ZERO		1 871	250	
EMB195	ICAO_A	2	6	Climb	MaxClimb	ZERO	7 500			
EMB195	ICAO_A	2	7	Climb	MaxClimb	ZERO	10 000			
EMB195	ICAO_A	3	1	Takeoff	MaxTakeoff	1				
EMB195	ICAO_A	3	2	Climb	MaxTakeoff	1	1 500			
EMB195	ICAO_A	3	3	Climb	MaxClimb	1	3 000			
EMB195	ICAO_A	3	4	Accelerate	MaxClimb	ZERO		1 467	201,3	
EMB195	ICAO_A	3	5	Accelerate	MaxClimb	ZERO		1 768	250	
EMB195	ICAO_A	3	6	Climb	MaxClimb	ZERO	7 500			
EMB195	ICAO_A	3	7	Climb	MaxClimb	ZERO	10 000			
EMB195	ICAO_A	4	1	Takeoff	MaxTakeoff	1				
EMB195	ICAO_A	4	2	Climb	MaxTakeoff	1	1 500			
EMB195	ICAO_A	4	3	Climb	MaxClimb	1	3 000			
EMB195	ICAO_A	4	4	Accelerate	MaxClimb	ZERO		1 336	206,2	
EMB195	ICAO_A	4	5	Accelerate	MaxClimb	ZERO		1 607	250	
EMB195	ICAO_A	4	6	Climb	MaxClimb	ZERO	7 500			
EMB195	ICAO_A	4	7	Climb	MaxClimb	ZERO	10 000			

ACFTID	Profile_ID	Stage Length	Step Number	Step Type	Thrust Rating	Flap_ID	End Point Altitude (ft)	Rate Of Climb (ft/min)	End Point CAS (kt)	Accelerate_Percent (%)
EMB195	ICAO_B	1	1	Takeoff	MaxTakeoff	1				
EMB195	ICAO_B	1	2	Climb	MaxTakeoff	1	1 000			
EMB195	ICAO_B	1	3	Accelerate	MaxTakeoff	ZERO		1 732	194,8	
EMB195	ICAO_B	1	4	Climb	MaxClimb	ZERO	3 000			
EMB195	ICAO_B	1	5	Accelerate	MaxClimb	ZERO		1 988	250	
EMB195	ICAO_B	1	6	Climb	MaxClimb	ZERO	5 500			
EMB195	ICAO_B	1	7	Climb	MaxClimb	ZERO	7 500			
EMB195	ICAO_B	1	8	Climb	MaxClimb	ZERO	10 000			
EMB195	ICAO_B	2	1	Takeoff	MaxTakeoff	1				
EMB195	ICAO_B	2	2	Climb	MaxTakeoff	1	1 000			
EMB195	ICAO_B	2	3	Accelerate	MaxTakeoff	ZERO		1 664	197	
EMB195	ICAO_B	2	4	Climb	MaxClimb	ZERO	3 000			
EMB195	ICAO_B	2	5	Accelerate	MaxClimb	ZERO		1 895	250	
EMB195	ICAO_B	2	6	Climb	MaxClimb	ZERO	5 500			
EMB195	ICAO_B	2	7	Climb	MaxClimb	ZERO	7 500			
EMB195	ICAO_B	2	8	Climb	MaxClimb	ZERO	10 000			
EMB195	ICAO_B	3	1	Takeoff	MaxTakeoff	1				
EMB195	ICAO_B	3	2	Climb	MaxTakeoff	1	1 000			
EMB195	ICAO_B	3	3	Accelerate	MaxTakeoff	ZERO		1 485	195	
EMB195	ICAO_B	3	4	Climb	MaxClimb	ZERO	3 000			

ACFTID	Profile_ID	Stage Length	Step Number	Step Type	Thrust Rating	Flap_ID	End Point Altitude (ft)	Rate Of Climb (ft/min)	End Point CAS (kt)	Accelerate_Percent (%)
EMB195	ICAO_B	3	5	Accelerate	MaxClimb	ZERO		1 800	250	
EMB195	ICAO_B	3	6	Climb	MaxClimb	ZERO	5 500			
EMB195	ICAO_B	3	7	Climb	MaxClimb	ZERO	7 500			
EMB195	ICAO_B	3	8	Climb	MaxClimb	ZERO	10 000			
EMB195	ICAO_B	4	1	Takeoff	MaxTakeoff	1				
EMB195	ICAO_B	4	2	Climb	MaxTakeoff	1	1 000			
EMB195	ICAO_B	4	3	Accelerate	MaxTakeoff	ZERO		1 468	205,4	
EMB195	ICAO_B	4	4	Climb	MaxClimb	ZERO	3 000			
EMB195	ICAO_B	4	5	Accelerate	MaxClimb	ZERO		1 631	250	
EMB195	ICAO_B	4	6	Climb	MaxClimb	ZERO	5 500			
EMB195	ICAO_B	4	7	Climb	MaxClimb	ZERO	7 500			
EMB195	ICAO_B	4	8	Climb	MaxClimb	ZERO	10 000			
F10062	DEFAULT	1	1	Takeoff	MaxTakeoff	TO				
F10062	DEFAULT	1	2	Climb	MaxTakeoff	TO	1 000			
F10062	DEFAULT	1	3	Accelerate	MaxTakeoff	TO		2 196	154	
F10062	DEFAULT	1	4	Accelerate	MaxTakeoff	TO		1 647	169	
F10062	DEFAULT	1	5	Accelerate	MaxClimb	TO		1 000	184	
F10062	DEFAULT	1	6	Climb	MaxClimb	TO	3 000			
F10062	DEFAULT	1	7	Accelerate	MaxClimb	TO		1 000	250	
F10062	DEFAULT	1	8	Climb	MaxClimb	TO	5 500			

ACFTID	Profile_ID	Stage Length	Step Number	Step Type	Thrust Rating	Flap_ID	End Point Altitude (ft)	Rate Of Climb (ft/min)	End Point CAS (kt)	Accelerate_Percent (%)
F10062	DEFAULT	1	9	Climb	MaxClimb	TO	7 500			
F10062	DEFAULT	1	10	Climb	MaxClimb	TO	10 000			
F10062	DEFAULT	2	1	Takeoff	MaxTakeoff	TO				
F10062	DEFAULT	2	2	Climb	MaxTakeoff	TO	1 000			
F10062	DEFAULT	2	3	Accelerate	MaxTakeoff	TO		1 982	161	
F10062	DEFAULT	2	4	Accelerate	MaxTakeoff	TO		1 487	176	
F10062	DEFAULT	2	5	Accelerate	MaxClimb	TO		1 000	191	
F10062	DEFAULT	2	6	Climb	MaxClimb	TO	3 000			
F10062	DEFAULT	2	7	Accelerate	MaxClimb	TO		1 000	250	
F10062	DEFAULT	2	8	Climb	MaxClimb	TO	5 500			
F10062	DEFAULT	2	9	Climb	MaxClimb	TO	7 500			
F10062	DEFAULT	2	10	Climb	MaxClimb	TO	10 000			
F10062	DEFAULT	3	1	Takeoff	MaxTakeoff	TO				
F10062	DEFAULT	3	2	Climb	MaxTakeoff	TO	1 000			
F10062	DEFAULT	3	3	Accelerate	MaxTakeoff	TO		1 819	167	
F10062	DEFAULT	3	4	Accelerate	MaxTakeoff	TO		1 364	182	
F10062	DEFAULT	3	5	Accelerate	MaxClimb	TO		1 000	197	
F10062	DEFAULT	3	6	Climb	MaxClimb	TO	3 000			
F10062	DEFAULT	3	7	Accelerate	MaxClimb	TO		1 000	250	
F10062	DEFAULT	3	8	Climb	MaxClimb	TO	5 500			

ACFTID	Profile_ID	Stage Length	Step Number	Step Type	Thrust Rating	Flap_ID	End Point Altitude (ft)	Rate Of Climb (ft/min)	End Point CAS (kt)	Accelerate_Percent (%)
F10062	DEFAULT	3	9	Climb	MaxClimb	TO	7 500			
F10062	DEFAULT	3	10	Climb	MaxClimb	TO	10 000			
F10065	DEFAULT	1	1	Takeoff	MaxTakeoff	TO				
F10065	DEFAULT	1	2	Climb	MaxTakeoff	TO	1 000			
F10065	DEFAULT	1	3	Accelerate	MaxTakeoff	TO		2 446	157	
F10065	DEFAULT	1	4	Accelerate	MaxTakeoff	TO		1 835	172	
F10065	DEFAULT	1	5	Accelerate	MaxClimb	TO		1 000	187	
F10065	DEFAULT	1	6	Climb	MaxClimb	TO	3 000			
F10065	DEFAULT	1	7	Accelerate	MaxClimb	TO		1 000	250	
F10065	DEFAULT	1	8	Climb	MaxClimb	TO	5 500			
F10065	DEFAULT	1	9	Climb	MaxClimb	TO	7 500			
F10065	DEFAULT	1	10	Climb	MaxClimb	TO	10 000			
F10065	DEFAULT	2	1	Takeoff	MaxTakeoff	TO				
F10065	DEFAULT	2	2	Climb	MaxTakeoff	TO	1 000			
F10065	DEFAULT	2	3	Accelerate	MaxTakeoff	TO		2 218	165	
F10065	DEFAULT	2	4	Accelerate	MaxTakeoff	TO		1 664	180	
F10065	DEFAULT	2	5	Accelerate	MaxClimb	TO		1 000	195	
F10065	DEFAULT	2	6	Climb	MaxClimb	TO	3 000			
F10065	DEFAULT	2	7	Accelerate	MaxClimb	TO		1 000	250	
F10065	DEFAULT	2	8	Climb	MaxClimb	TO	5 500			
F10065	DEFAULT	2	9	Climb	MaxClimb	TO	7 500			

ACFTID	Profile_ID	Stage Length	Step Number	Step Type	Thrust Rating	Flap_ID	End Point Altitude (ft)	Rate Of Climb (ft/min)	End Point CAS (kt)	Accelerate_Percent (%)
F10065	DEFAULT	2	10	Climb	MaxClimb	TO	10 000			
F10065	DEFAULT	3	1	Takeoff	MaxTakeoff	TO				
F10065	DEFAULT	3	2	Climb	MaxTakeoff	TO	1 000			
F10065	DEFAULT	3	3	Accelerate	MaxTakeoff	TO		2 021	171	
F10065	DEFAULT	3	4	Accelerate	MaxTakeoff	TO		1 516	186	
F10065	DEFAULT	3	5	Accelerate	MaxClimb	TO		1 000	201	
F10065	DEFAULT	3	6	Climb	MaxClimb	TO	3 000			
F10065	DEFAULT	3	7	Accelerate	MaxClimb	TO		1 000	250	
F10065	DEFAULT	3	8	Climb	MaxClimb	TO	5 500			
F10065	DEFAULT	3	9	Climb	MaxClimb	TO	7 500			
F10065	DEFAULT	3	10	Climb	MaxClimb	TO	10 000			
F28MK2	DEFAULT	1	1	Takeoff	MaxTakeoff	6				
F28MK2	DEFAULT	1	2	Climb	MaxTakeoff	6	1 000			
F28MK2	DEFAULT	1	3	Accelerate	MaxTakeoff	6		2 229	155	
F28MK2	DEFAULT	1	4	Accelerate	MaxTakeoff	ZERO		1 672	170	
F28MK2	DEFAULT	1	5	Accelerate	MaxClimb	ZERO		1 000	185	
F28MK2	DEFAULT	1	6	Climb	MaxClimb	ZERO	3 000			
F28MK2	DEFAULT	1	7	Accelerate	MaxClimb	ZERO		1 000	250	
F28MK2	DEFAULT	1	8	Climb	MaxClimb	ZERO	5 500			
F28MK2	DEFAULT	1	9	Climb	MaxClimb	ZERO	7 500			

ACFTID	Profile_ID	Stage Length	Step Number	Step Type	Thrust Rating	Flap_ID	End Point Altitude (ft)	Rate Of Climb (ft/min)	End Point CAS (kt)	Accelerate_Percent (%)
F28MK2	DEFAULT	1	10	Climb	MaxClimb	ZERO	10 000			
F28MK2	DEFAULT	2	1	Takeoff	MaxTakeoff	6				
F28MK2	DEFAULT	2	2	Climb	MaxTakeoff	6	1 000			
F28MK2	DEFAULT	2	3	Accelerate	MaxTakeoff	6		2 011	162	
F28MK2	DEFAULT	2	4	Accelerate	MaxTakeoff	ZERO		1 508	177	
F28MK2	DEFAULT	2	5	Accelerate	MaxClimb	ZERO		1 000	192	
F28MK2	DEFAULT	2	6	Climb	MaxClimb	ZERO	3 000			
F28MK2	DEFAULT	2	7	Accelerate	MaxClimb	ZERO		1 000	250	
F28MK2	DEFAULT	2	8	Climb	MaxClimb	ZERO	5 500			
F28MK2	DEFAULT	2	9	Climb	MaxClimb	ZERO	7 500			
F28MK2	DEFAULT	2	10	Climb	MaxClimb	ZERO	10 000			
F28MK4	DEFAULT	1	1	Takeoff	MaxTakeoff	6				
F28MK4	DEFAULT	1	2	Climb	MaxTakeoff	6	1 000			
F28MK4	DEFAULT	1	3	Accelerate	MaxTakeoff	6		2 103	152	
F28MK4	DEFAULT	1	4	Accelerate	MaxTakeoff	ZERO		1 578	167	
F28MK4	DEFAULT	1	5	Accelerate	MaxClimb	ZERO		1 000	182	
F28MK4	DEFAULT	1	6	Climb	MaxClimb	ZERO	3 000			
F28MK4	DEFAULT	1	7	Accelerate	MaxClimb	ZERO		1 000	250	
F28MK4	DEFAULT	1	8	Climb	MaxClimb	ZERO	5 500			
F28MK4	DEFAULT	1	9	Climb	MaxClimb	ZERO	7 500			

ACFTID	Profile_ID	Stage Length	Step Number	Step Type	Thrust Rating	Flap_ID	End Point Altitude (ft)	Rate Of Climb (ft/min)	End Point CAS (kt)	Accelerate_Percent (%)
F28MK4	DEFAULT	1	10	Climb	MaxClimb	ZERO	10 000			
F28MK4	DEFAULT	2	1	Takeoff	MaxTakeoff	6				
F28MK4	DEFAULT	2	2	Climb	MaxTakeoff	6	1 000			
F28MK4	DEFAULT	2	3	Accelerate	MaxTakeoff	6		1 941	157	
F28MK4	DEFAULT	2	4	Accelerate	MaxTakeoff	ZERO		1 456	172	
F28MK4	DEFAULT	2	5	Accelerate	MaxClimb	ZERO		1 000	187	
F28MK4	DEFAULT	2	6	Climb	MaxClimb	ZERO	3 000			
F28MK4	DEFAULT	2	7	Accelerate	MaxClimb	ZERO		1 000	250	
F28MK4	DEFAULT	2	8	Climb	MaxClimb	ZERO	5 500			
F28MK4	DEFAULT	2	9	Climb	MaxClimb	ZERO	7 500			
F28MK4	DEFAULT	2	10	Climb	MaxClimb	ZERO	10 000			
F28MK4	DEFAULT	3	1	Takeoff	MaxTakeoff	6				
F28MK4	DEFAULT	3	2	Climb	MaxTakeoff	6	1 000			
F28MK4	DEFAULT	3	3	Accelerate	MaxTakeoff	6		1 743	165	
F28MK4	DEFAULT	3	4	Accelerate	MaxTakeoff	6		1 307	180	
F28MK4	DEFAULT	3	5	Accelerate	MaxClimb	ZERO		1 000	195	
F28MK4	DEFAULT	3	6	Climb	MaxClimb	ZERO	3 000			
F28MK4	DEFAULT	3	7	Accelerate	MaxClimb	ZERO		1 000	250	
F28MK4	DEFAULT	3	8	Climb	MaxClimb	ZERO	5 500			
F28MK4	DEFAULT	3	9	Climb	MaxClimb	ZERO	7 500			

ACFTID	Profile_ID	Stage Length	Step Number	Step Type	Thrust Rating	Flap_ID	End Point Altitude (ft)	Rate Of Climb (ft/min)	End Point CAS (kt)	Accelerate_Percent (%)
F28MK4	DEFAULT	3	10	Climb	MaxClimb	ZERO	10 000			
FAL20	DEFAULT	1	1	Takeoff	MaxTakeoff	10				
FAL20	DEFAULT	1	2	Accelerate	MaxTakeoff	10		1 388	152	
FAL20	DEFAULT	1	3	Climb	MaxTakeoff	10	1 500			
FAL20	DEFAULT	1	4	Accelerate	MaxTakeoff	10		1 388	162	
FAL20	DEFAULT	1	5	Accelerate	MaxClimb	INTR		1 041	177	
FAL20	DEFAULT	1	6	Climb	MaxClimb	ZERO	3 000			
FAL20	DEFAULT	1	7	Accelerate	MaxClimb	ZERO		1 432	250	
FAL20	DEFAULT	1	8	Climb	MaxClimb	ZERO	5 500			
FAL20	DEFAULT	1	9	Climb	MaxClimb	ZERO	7 500			
FAL20	DEFAULT	1	10	Climb	MaxClimb	ZERO	10 000			
GII	DEFAULT	1	1	Takeoff	ReduceTake-off	T-20-D				
GII	DEFAULT	1	2	Climb	ReduceTake-off	T-20-D	35			
GII	DEFAULT	1	3	Accelerate	ReduceTake-off	T-20-D		1 500	162	
GII	DEFAULT	1	4	Climb	ReduceTake-off	T-20-D	400			
GII	DEFAULT	1	5	Climb	Reduce-Climb	T-10-U	520			
GII	DEFAULT	1	6	Climb	Reduce-Climb	T-10-U	1 500			
GII	DEFAULT	1	7	Climb	Reduce-Climb	T-10-U	3 000			
GII	DEFAULT	1	8	Accelerate	MaxClimb	T-0-U		1 675	192	
GII	DEFAULT	1	9	Accelerate	MaxClimb	T-0-U		1 775	250	

ACFTID	Profile_ID	Stage Length	Step Number	Step Type	Thrust Rating	Flap_ID	End Point Altitude (ft)	Rate Of Climb (ft/min)	End Point CAS (kt)	Accelerate_Percent (%)
GII	DEFAULT	1	10	Climb	MaxClimb	T-0-U	5 500			
GII	DEFAULT	1	11	Climb	MaxClimb	T-0-U	7 500			
GII	DEFAULT	1	12	Climb	MaxClimb	T-0-U	10 000			
GII	QF_FULL	1	1	Takeoff	MaxTakeoff	T-20-D				
GII	QF_FULL	1	2	Climb	MaxTakeoff	T-20-D	35			
GII	QF_FULL	1	3	Accelerate	MaxTakeoff	T-20-D		1 500	162	
GII	QF_FULL	1	4	Climb	MaxTakeoff	T-20-D	400			
GII	QF_FULL	1	5	Climb	Reduce-Climb	T-10-U	520			
GII	QF_FULL	1	6	Climb	Reduce-Climb	T-10-U	1 500			
GII	QF_FULL	1	7	Climb	Reduce-Climb	T-10-U	3 000			
GII	QF_FULL	1	8	Accelerate	MaxClimb	T-0-U		1 675	192	
GII	QF_FULL	1	9	Accelerate	MaxClimb	T-0-U		1 775	250	
GII	QF_FULL	1	10	Climb	MaxClimb	T-0-U	5 500			
GII	QF_FULL	1	11	Climb	MaxClimb	T-0-U	7 500			
GII	QF_FULL	1	12	Climb	MaxClimb	T-0-U	10 000			
GII B	DEFAULT	1	1	Takeoff	ReduceTake-off	T-20-D				
GII B	DEFAULT	1	2	Climb	ReduceTake-off	T-20-D	35			
GII B	DEFAULT	1	3	Accelerate	ReduceTake-off	T-20-D		1 500	156	
GII B	DEFAULT	1	4	Climb	ReduceTake-off	T-20-D	400			
GII B	DEFAULT	1	5	Climb	Reduce-Climb	T-10-U	520			

ACFTID	Profile_ID	Stage Length	Step Number	Step Type	Thrust Rating	Flap_ID	End Point Altitude (ft)	Rate Of Climb (ft/min)	End Point CAS (kt)	Accelerate_Percent (%)
GIB	DEFAULT	1	6	Climb	Reduce-Climb	T-10-U	1 500			
GIB	DEFAULT	1	7	Climb	Reduce-Climb	T-10-U	3 000			
GIB	DEFAULT	1	8	Accelerate	MaxClimb	T-0-U		1 675	192	
GIB	DEFAULT	1	9	Accelerate	MaxClimb	T-0-U		1 775	250	
GIB	DEFAULT	1	10	Climb	MaxClimb	T-0-U	5 500			
GIB	DEFAULT	1	11	Climb	MaxClimb	T-0-U	7 500			
GIB	DEFAULT	1	12	Climb	MaxClimb	T-0-U	10 000			
GIB	QF_FULL	1	1	Takeoff	MaxTakeoff	T-20-D				
GIB	QF_FULL	1	2	Climb	MaxTakeoff	T-20-D	35			
GIB	QF_FULL	1	3	Accelerate	MaxTakeoff	T-20-D		1 500	156	
GIB	QF_FULL	1	4	Climb	MaxTakeoff	T-20-D	400			
GIB	QF_FULL	1	5	Climb	Reduce-Climb	T-10-U	520			
GIB	QF_FULL	1	6	Climb	Reduce-Climb	T-10-U	1 500			
GIB	QF_FULL	1	7	Climb	Reduce-Climb	T-10-U	3 000			
GIB	QF_FULL	1	8	Accelerate	MaxClimb	T-0-U		1 675	192	
GIB	QF_FULL	1	9	Accelerate	MaxClimb	T-0-U		1 775	250	
GIB	QF_FULL	1	10	Climb	MaxClimb	T-0-U	5 500			
GIB	QF_FULL	1	11	Climb	MaxClimb	T-0-U	7 500			
GIB	QF_FULL	1	12	Climb	MaxClimb	T-0-U	10 000			
GIV	DEFAULT	1	1	Takeoff	MaxTakeoff	T-20-D				

ACFTID	Profile_ID	Stage Length	Step Number	Step Type	Thrust Rating	Flap_ID	End Point Altitude (ft)	Rate Of Climb (ft/min)	End Point CAS (kt)	Accelerate_Percent (%)
GIV	DEFAULT	1	2	Climb	MaxTakeoff	T-20-D	35			
GIV	DEFAULT	1	3	Accelerate	MaxTakeoff	T-20-D		1 800	159,2	
GIV	DEFAULT	1	4	Climb	MaxTakeoff	T-20-U	400			
GIV	DEFAULT	1	5	Climb	MaxClimb	T-20-U	600			
GIV	DEFAULT	1	6	Climb	MaxClimb	T-20-U	750			
GIV	DEFAULT	1	7	Climb	MaxClimb	T-10-U	1 850			
GIV	DEFAULT	1	8	Climb	MaxClimb	T-10-U	3 000			
GIV	DEFAULT	1	9	Accelerate	MaxClimb	T-0-U		1 750	250	
GIV	DEFAULT	1	10	Climb	MaxClimb	T-0-U	5 000			
GIV	DEFAULT	1	11	Climb	MaxClimb	T-0-U	6 000			
GIV	DEFAULT	1	12	Climb	MaxClimb	T-0-U	7 000			
GIV	DEFAULT	1	13	Climb	MaxClimb	T-0-U	8 000			
GIV	DEFAULT	1	14	Climb	MaxClimb	T-0-U	9 000			
GIV	DEFAULT	1	15	Climb	MaxClimb	T-0-U	10 000			
GV	DEFAULT	1	1	Takeoff	MaxTakeoff	T-20-D				
GV	DEFAULT	1	2	Climb	MaxTakeoff	T-20-D	35			
GV	DEFAULT	1	3	Accelerate	MaxTakeoff	T-20-D		1 500	165,7	
GV	DEFAULT	1	4	Climb	MaxTakeoff	T-20-U	400			
GV	DEFAULT	1	5	Climb	MaxClimb	T-20-U	600			
GV	DEFAULT	1	6	Climb	MaxClimb	T-20-U	750			

ACFTID	Profile_ID	Stage Length	Step Number	Step Type	Thrust Rating	Flap_ID	End Point Altitude (ft)	Rate Of Climb (ft/min)	End Point CAS (kt)	Accelerate_Percent (%)
GV	DEFAULT	1	7	Climb	MaxClimb	T-10-U	1 800			
GV	DEFAULT	1	8	Climb	MaxClimb	T-10-U	3 000			
GV	DEFAULT	1	9	Accelerate	MaxClimb	T-0-U		1 750	250	
GV	DEFAULT	1	10	Climb	MaxClimb	T-0-U	5 000			
GV	DEFAULT	1	11	Climb	MaxClimb	T-0-U	6 000			
GV	DEFAULT	1	12	Climb	MaxClimb	T-0-U	7 000			
GV	DEFAULT	1	13	Climb	MaxClimb	T-0-U	8 000			
GV	DEFAULT	1	14	Climb	MaxClimb	T-0-U	9 000			
GV	DEFAULT	1	15	Climb	MaxClimb	T-0-U	10 000			
HS748A	DEFAULT	1	1	Takeoff	MaxTakeoff	TO				
HS748A	DEFAULT	1	2	Climb	MaxTakeoff	TO	1 000			
HS748A	DEFAULT	1	3	Accelerate	MaxTakeoff	TO		917	127	
HS748A	DEFAULT	1	4	Accelerate	MaxClimb	INTR		688	147	
HS748A	DEFAULT	1	5	Climb	MaxClimb	ZERO	3 000			
HS748A	DEFAULT	1	6	Climb	MaxClimb	ZERO	5 500			
HS748A	DEFAULT	1	7	Climb	MaxClimb	ZERO	7 500			
HS748A	DEFAULT	1	8	Climb	MaxClimb	ZERO	10 000			
IA1125	DEFAULT	1	1	Takeoff	MaxTakeoff	12				
IA1125	DEFAULT	1	2	Accelerate	MaxTakeoff	12		1 094	163	
IA1125	DEFAULT	1	3	Climb	MaxTakeoff	12	1 500			

ACFTID	Profile_ID	Stage Length	Step Number	Step Type	Thrust Rating	Flap_ID	End Point Altitude (ft)	Rate Of Climb (ft/min)	End Point CAS (kt)	Accelerate_Percent (%)
IA1125	DEFAULT	1	4	Accelerate	MaxTakeoff	INTR		1 094	188	
IA1125	DEFAULT	1	5	Climb	MaxClimb	ZERO	3 000			
IA1125	DEFAULT	1	6	Accelerate	MaxClimb	ZERO		1 286	250	
IA1125	DEFAULT	1	7	Climb	MaxClimb	ZERO	5 500			
IA1125	DEFAULT	1	8	Climb	MaxClimb	ZERO	7 500			
IA1125	DEFAULT	1	9	Climb	MaxClimb	ZERO	10 000			
L1011	DEFAULT	1	1	Takeoff	MaxTakeoff	10				
L1011	DEFAULT	1	2	Climb	MaxTakeoff	10	1 000			
L1011	DEFAULT	1	3	Accelerate	MaxTakeoff	10		2 145	162	
L1011	DEFAULT	1	4	Accelerate	MaxTakeoff	INTR		1 609	182	
L1011	DEFAULT	1	5	Accelerate	MaxClimb	INTR		1 000	202	
L1011	DEFAULT	1	6	Climb	MaxClimb	ZERO	3 000			
L1011	DEFAULT	1	7	Accelerate	MaxClimb	ZERO		1 000	250	
L1011	DEFAULT	1	8	Climb	MaxClimb	ZERO	5 500			
L1011	DEFAULT	1	9	Climb	MaxClimb	ZERO	7 500			
L1011	DEFAULT	1	10	Climb	MaxClimb	ZERO	10 000			
L1011	DEFAULT	2	1	Takeoff	MaxTakeoff	10				
L1011	DEFAULT	2	2	Climb	MaxTakeoff	10	1 000			
L1011	DEFAULT	2	3	Accelerate	MaxTakeoff	10		2 068	165	
L1011	DEFAULT	2	4	Accelerate	MaxTakeoff	INTR		1 551	185	

ACFTID	Profile_ID	Stage Length	Step Number	Step Type	Thrust Rating	Flap_ID	End Point Altitude (ft)	Rate Of Climb (ft/min)	End Point CAS (kt)	Accelerate_Percent (%)
L1011	DEFAULT	2	5	Accelerate	MaxClimb	INTR		1 000	205	
L1011	DEFAULT	2	6	Climb	MaxClimb	ZERO	3 000			
L1011	DEFAULT	2	7	Accelerate	MaxClimb	ZERO		1 000	250	
L1011	DEFAULT	2	8	Climb	MaxClimb	ZERO	5 500			
L1011	DEFAULT	2	9	Climb	MaxClimb	ZERO	7 500			
L1011	DEFAULT	2	10	Climb	MaxClimb	ZERO	10 000			
L1011	DEFAULT	3	1	Takeoff	MaxTakeoff	10				
L1011	DEFAULT	3	2	Climb	MaxTakeoff	10	1 000			
L1011	DEFAULT	3	3	Accelerate	MaxTakeoff	10		1 959	168	
L1011	DEFAULT	3	4	Accelerate	MaxTakeoff	INTR		1 469	188	
L1011	DEFAULT	3	5	Accelerate	MaxClimb	INTR		1 000	208	
L1011	DEFAULT	3	6	Climb	MaxClimb	ZERO	3 000			
L1011	DEFAULT	3	7	Accelerate	MaxClimb	ZERO		1 000	250	
L1011	DEFAULT	3	8	Climb	MaxClimb	ZERO	5 500			
L1011	DEFAULT	3	9	Climb	MaxClimb	ZERO	7 500			
L1011	DEFAULT	3	10	Climb	MaxClimb	ZERO	10 000			
L1011	DEFAULT	4	1	Takeoff	MaxTakeoff	10				
L1011	DEFAULT	4	2	Climb	MaxTakeoff	10	1 000			
L1011	DEFAULT	4	3	Accelerate	MaxTakeoff	10		1 857	171	
L1011	DEFAULT	4	4	Accelerate	MaxTakeoff	INTR		1 393	191	

ACFTID	Profile_ID	Stage Length	Step Number	Step Type	Thrust Rating	Flap_ID	End Point Altitude (ft)	Rate Of Climb (ft/min)	End Point CAS (kt)	Accelerate_Percent (%)
L1011	DEFAULT	4	5	Accelerate	MaxClimb	INTR		1 000	211	
L1011	DEFAULT	4	6	Climb	MaxClimb	ZERO	3 000			
L1011	DEFAULT	4	7	Accelerate	MaxClimb	ZERO		1 000	250	
L1011	DEFAULT	4	8	Climb	MaxClimb	ZERO	5 500			
L1011	DEFAULT	4	9	Climb	MaxClimb	ZERO	7 500			
L1011	DEFAULT	4	10	Climb	MaxClimb	ZERO	10 000			
L1011	DEFAULT	5	1	Takeoff	MaxTakeoff	10				
L1011	DEFAULT	5	2	Climb	MaxTakeoff	10	1 000			
L1011	DEFAULT	5	3	Accelerate	MaxTakeoff	10		1 669	178	
L1011	DEFAULT	5	4	Accelerate	MaxTakeoff	INTR		1 252	198	
L1011	DEFAULT	5	5	Accelerate	MaxClimb	INTR		1 000	218	
L1011	DEFAULT	5	6	Climb	MaxClimb	ZERO	3 000			
L1011	DEFAULT	5	7	Accelerate	MaxClimb	ZERO		1 000	250	
L1011	DEFAULT	5	8	Climb	MaxClimb	ZERO	5 500			
L1011	DEFAULT	5	9	Climb	MaxClimb	ZERO	7 500			
L1011	DEFAULT	5	10	Climb	MaxClimb	ZERO	10 000			
L1011	DEFAULT	6	1	Takeoff	MaxTakeoff	10				
L1011	DEFAULT	6	2	Climb	MaxTakeoff	10	1 000			
L1011	DEFAULT	6	3	Accelerate	MaxTakeoff	10		1 501	184	
L1011	DEFAULT	6	4	Accelerate	MaxTakeoff	INTR		1 126	204	

ACFTID	Profile_ID	Stage Length	Step Number	Step Type	Thrust Rating	Flap_ID	End Point Altitude (ft)	Rate Of Climb (ft/min)	End Point CAS (kt)	Accelerate_Percent (%)
L1011	DEFAULT	6	5	Accelerate	MaxClimb	INTR		1 000	224	
L1011	DEFAULT	6	6	Climb	MaxClimb	ZERO	3 000			
L1011	DEFAULT	6	7	Accelerate	MaxClimb	ZERO		1 000	250	
L1011	DEFAULT	6	8	Climb	MaxClimb	ZERO	5 500			
L1011	DEFAULT	6	9	Climb	MaxClimb	ZERO	7 500			
L1011	DEFAULT	6	10	Climb	MaxClimb	ZERO	10 000			
L10115	DEFAULT	1	1	Takeoff	MaxTakeoff	10				
L10115	DEFAULT	1	2	Climb	MaxTakeoff	10	1 000			
L10115	DEFAULT	1	3	Accelerate	MaxTakeoff	10		2 632	166	
L10115	DEFAULT	1	4	Accelerate	MaxTakeoff	INTR		1 974	186	
L10115	DEFAULT	1	5	Accelerate	MaxClimb	INTR		1 000	206	
L10115	DEFAULT	1	6	Climb	MaxClimb	ZERO	3 000			
L10115	DEFAULT	1	7	Accelerate	MaxClimb	ZERO		1 000	250	
L10115	DEFAULT	1	8	Climb	MaxClimb	ZERO	5 500			
L10115	DEFAULT	1	9	Climb	MaxClimb	ZERO	7 500			
L10115	DEFAULT	1	10	Climb	MaxClimb	ZERO	10 000			
L10115	DEFAULT	2	1	Takeoff	MaxTakeoff	10				
L10115	DEFAULT	2	2	Climb	MaxTakeoff	10	1 000			
L10115	DEFAULT	2	3	Accelerate	MaxTakeoff	10		2 547	168	
L10115	DEFAULT	2	4	Accelerate	MaxTakeoff	INTR		1 911	188	

ACFTID	Profile_ID	Stage Length	Step Number	Step Type	Thrust Rating	Flap_ID	End Point Altitude (ft)	Rate Of Climb (ft/min)	End Point CAS (kt)	Accelerate_Percent (%)
L10115	DEFAULT	2	5	Accelerate	MaxClimb	INTR		1 000	208	
L10115	DEFAULT	2	6	Climb	MaxClimb	ZERO	3 000			
L10115	DEFAULT	2	7	Accelerate	MaxClimb	ZERO		1 000	250	
L10115	DEFAULT	2	8	Climb	MaxClimb	ZERO	5 500			
L10115	DEFAULT	2	9	Climb	MaxClimb	ZERO	7 500			
L10115	DEFAULT	2	10	Climb	MaxClimb	ZERO	10 000			
L10115	DEFAULT	3	1	Takeoff	MaxTakeoff	10				
L10115	DEFAULT	3	2	Climb	MaxTakeoff	10	1 000			
L10115	DEFAULT	3	3	Accelerate	MaxTakeoff	10		2 428	171	
L10115	DEFAULT	3	4	Accelerate	MaxTakeoff	INTR		1 821	191	
L10115	DEFAULT	3	5	Accelerate	MaxClimb	INTR		1 000	211	
L10115	DEFAULT	3	6	Climb	MaxClimb	ZERO	3 000			
L10115	DEFAULT	3	7	Accelerate	MaxClimb	ZERO		1 000	250	
L10115	DEFAULT	3	8	Climb	MaxClimb	ZERO	5 500			
L10115	DEFAULT	3	9	Climb	MaxClimb	ZERO	7 500			
L10115	DEFAULT	3	10	Climb	MaxClimb	ZERO	10 000			
L10115	DEFAULT	4	1	Takeoff	MaxTakeoff	10				
L10115	DEFAULT	4	2	Climb	MaxTakeoff	10	1 000			
L10115	DEFAULT	4	3	Accelerate	MaxTakeoff	10		2 317	175	
L10115	DEFAULT	4	4	Accelerate	MaxTakeoff	INTR		1 738	195	

ACFTID	Profile_ID	Stage Length	Step Number	Step Type	Thrust Rating	Flap_ID	End Point Altitude (ft)	Rate Of Climb (ft/min)	End Point CAS (kt)	Accelerate_Percent (%)
L10115	DEFAULT	4	5	Accelerate	MaxClimb	INTR		1 000	215	
L10115	DEFAULT	4	6	Climb	MaxClimb	ZERO	3 000			
L10115	DEFAULT	4	7	Accelerate	MaxClimb	ZERO		1 000	250	
L10115	DEFAULT	4	8	Climb	MaxClimb	ZERO	5 500			
L10115	DEFAULT	4	9	Climb	MaxClimb	ZERO	7 500			
L10115	DEFAULT	4	10	Climb	MaxClimb	ZERO	10 000			
L10115	DEFAULT	5	1	Takeoff	MaxTakeoff	10				
L10115	DEFAULT	5	2	Climb	MaxTakeoff	10	1 000			
L10115	DEFAULT	5	3	Accelerate	MaxTakeoff	10		2 125	181	
L10115	DEFAULT	5	4	Accelerate	MaxTakeoff	INTR		1 594	201	
L10115	DEFAULT	5	5	Accelerate	MaxClimb	INTR		1 000	221	
L10115	DEFAULT	5	6	Climb	MaxClimb	ZERO	3 000			
L10115	DEFAULT	5	7	Accelerate	MaxClimb	ZERO		1 000	250	
L10115	DEFAULT	5	8	Climb	MaxClimb	ZERO	5 500			
L10115	DEFAULT	5	9	Climb	MaxClimb	ZERO	7 500			
L10115	DEFAULT	5	10	Climb	MaxClimb	ZERO	10 000			
L10115	DEFAULT	6	1	Takeoff	MaxTakeoff	10				
L10115	DEFAULT	6	2	Climb	MaxTakeoff	10	1 000			
L10115	DEFAULT	6	3	Accelerate	MaxTakeoff	10		1 953	186	
L10115	DEFAULT	6	4	Accelerate	MaxTakeoff	INTR		1 465	206	

ACFTID	Profile_ID	Stage Length	Step Number	Step Type	Thrust Rating	Flap_ID	End Point Altitude (ft)	Rate Of Climb (ft/min)	End Point CAS (kt)	Accelerate_Percent (%)
L10115	DEFAULT	6	5	Accelerate	MaxClimb	INTR		1 000	226	
L10115	DEFAULT	6	6	Climb	MaxClimb	ZERO	3 000			
L10115	DEFAULT	6	7	Accelerate	MaxClimb	ZERO		1 000	250	
L10115	DEFAULT	6	8	Climb	MaxClimb	ZERO	5 500			
L10115	DEFAULT	6	9	Climb	MaxClimb	ZERO	7 500			
L10115	DEFAULT	6	10	Climb	MaxClimb	ZERO	10 000			
L10115	DEFAULT	7	1	Takeoff	MaxTakeoff	10				
L10115	DEFAULT	7	2	Climb	MaxTakeoff	10	1 000			
L10115	DEFAULT	7	3	Accelerate	MaxTakeoff	10		1 790	192	
L10115	DEFAULT	7	4	Accelerate	MaxTakeoff	INTR		1 343	212	
L10115	DEFAULT	7	5	Accelerate	MaxClimb	INTR		1 000	232	
L10115	DEFAULT	7	6	Climb	MaxClimb	ZERO	3 000			
L10115	DEFAULT	7	7	Accelerate	MaxClimb	ZERO		1 000	250	
L10115	DEFAULT	7	8	Climb	MaxClimb	ZERO	5 500			
L10115	DEFAULT	7	9	Climb	MaxClimb	ZERO	7 500			
L10115	DEFAULT	7	10	Climb	MaxClimb	ZERO	10 000			
L188	DEFAULT	1	1	Takeoff	MaxTakeoff	78-%				
L188	DEFAULT	1	2	Climb	MaxTakeoff	78-%	1 000			
L188	DEFAULT	1	3	Accelerate	MaxTakeoff	78-%		1 653	133	
L188	DEFAULT	1	4	Accelerate	MaxClimb	INTR		1 240	153	

ACFTID	Profile_ID	Stage Length	Step Number	Step Type	Thrust Rating	Flap_ID	End Point Altitude (ft)	Rate Of Climb (ft/min)	End Point CAS (kt)	Accelerate_Percent (%)
L188	DEFAULT	1	5	Climb	MaxClimb	ZERO	3 000			
L188	DEFAULT	1	6	Climb	MaxClimb	ZERO	5 500			
L188	DEFAULT	1	7	Climb	MaxClimb	ZERO	7 500			
L188	DEFAULT	1	8	Climb	MaxClimb	ZERO	10 000			
L188	DEFAULT	2	1	Takeoff	MaxTakeoff	78-%				
L188	DEFAULT	2	2	Climb	MaxTakeoff	78-%	1 000			
L188	DEFAULT	2	3	Accelerate	MaxTakeoff	78-%		1 309	139	
L188	DEFAULT	2	4	Accelerate	MaxClimb	INTR		982	159	
L188	DEFAULT	2	5	Climb	MaxClimb	ZERO	3 000			
L188	DEFAULT	2	6	Climb	MaxClimb	ZERO	5 500			
L188	DEFAULT	2	7	Climb	MaxClimb	ZERO	7 500			
L188	DEFAULT	2	8	Climb	MaxClimb	ZERO	10 000			
L188	DEFAULT	3	1	Takeoff	MaxTakeoff	78-%				
L188	DEFAULT	3	2	Climb	MaxTakeoff	78-%	1 000			
L188	DEFAULT	3	3	Accelerate	MaxTakeoff	78-%		905	147	
L188	DEFAULT	3	4	Accelerate	MaxClimb	INTR		679	167	
L188	DEFAULT	3	5	Climb	MaxClimb	ZERO	3 000			
L188	DEFAULT	3	6	Climb	MaxClimb	ZERO	5 500			
L188	DEFAULT	3	7	Climb	MaxClimb	ZERO	7 500			
L188	DEFAULT	3	8	Climb	MaxClimb	ZERO	10 000			

ACFTID	Profile_ID	Stage Length	Step Number	Step Type	Thrust Rating	Flap_ID	End Point Altitude (ft)	Rate Of Climb (ft/min)	End Point CAS (kt)	Accelerate_Percent (%)
LEAR25	DEFAULT	1	1	Takeoff	MaxTakeoff	20				
LEAR25	DEFAULT	1	2	Accelerate	MaxTakeoff	20		1 698	171	
LEAR25	DEFAULT	1	3	Climb	MaxTakeoff	20	1 500			
LEAR25	DEFAULT	1	4	Accelerate	MaxTakeoff	10		1 698	196	
LEAR25	DEFAULT	1	5	Climb	MaxClimb	ZERO	3 000			
LEAR25	DEFAULT	1	6	Accelerate	MaxClimb	ZERO		2 075	250	
LEAR25	DEFAULT	1	7	Climb	MaxClimb	ZERO	5 500			
LEAR25	DEFAULT	1	8	Climb	MaxClimb	ZERO	7 500			
LEAR25	DEFAULT	1	9	Climb	MaxClimb	ZERO	10 000			
LEAR35	DEFAULT	1	1	Takeoff	MaxTakeoff	20				
LEAR35	DEFAULT	1	2	Accelerate	MaxTakeoff	20		1 493	158	
LEAR35	DEFAULT	1	3	Climb	MaxTakeoff	20	1 500			
LEAR35	DEFAULT	1	4	Accelerate	MaxTakeoff	10		1 493	183	
LEAR35	DEFAULT	1	5	Climb	MaxClimb	ZERO	3 000			
LEAR35	DEFAULT	1	6	Accelerate	MaxClimb	ZERO		1 706	250	
LEAR35	DEFAULT	1	7	Climb	MaxClimb	ZERO	5 500			
LEAR35	DEFAULT	1	8	Climb	MaxClimb	ZERO	7 500			
LEAR35	DEFAULT	1	9	Climb	MaxClimb	ZERO	10 000			
MD11GE	DEFAULT	1	1	Takeoff	MaxTakeoff	25				
MD11GE	DEFAULT	1	2	Climb	MaxTakeoff	25	1 000			

ACFTID	Profile_ID	Stage Length	Step Number	Step Type	Thrust Rating	Flap_ID	End Point Altitude (ft)	Rate Of Climb (ft/min)	End Point CAS (kt)	Accelerate_Percent (%)
MD11GE	DEFAULT	1	3	Accelerate	MaxTakeoff	0/EXT		1 500	211	
MD11GE	DEFAULT	1	4	Climb	MaxClimb	0/EXT	2 000			
MD11GE	DEFAULT	1	5	Climb	MaxClimb	0/EXT	3 000			
MD11GE	DEFAULT	1	6	Accelerate	MaxClimb	0/RET		1 500	250	
MD11GE	DEFAULT	1	7	Climb	MaxClimb	0/RET	10 000			
MD11GE	DEFAULT	2	1	Takeoff	MaxTakeoff	25				
MD11GE	DEFAULT	2	2	Climb	MaxTakeoff	25	1 000			
MD11GE	DEFAULT	2	3	Accelerate	MaxTakeoff	0/EXT		1 500	210	
MD11GE	DEFAULT	2	4	Climb	MaxClimb	0/EXT	2 000			
MD11GE	DEFAULT	2	5	Climb	MaxClimb	0/EXT	3 000			
MD11GE	DEFAULT	2	6	Accelerate	MaxClimb	0/RET		1 500	250	
MD11GE	DEFAULT	2	7	Climb	MaxClimb	0/RET	10 000			
MD11GE	DEFAULT	3	1	Takeoff	MaxTakeoff	25				
MD11GE	DEFAULT	3	2	Climb	MaxTakeoff	25	1 000			
MD11GE	DEFAULT	3	3	Accelerate	MaxTakeoff	0/EXT		1 500	210	
MD11GE	DEFAULT	3	4	Climb	MaxClimb	0/EXT	2 000			
MD11GE	DEFAULT	3	5	Climb	MaxClimb	0/EXT	3 000			
MD11GE	DEFAULT	3	6	Accelerate	MaxClimb	0/RET		1 500	250	
MD11GE	DEFAULT	3	7	Climb	MaxClimb	0/RET	10 000			
MD11GE	DEFAULT	4	1	Takeoff	MaxTakeoff	25				

ACFTID	Profile_ID	Stage Length	Step Number	Step Type	Thrust Rating	Flap_ID	End Point Altitude (ft)	Rate Of Climb (ft/min)	End Point CAS (kt)	Accelerate_Percent (%)
MD11GE	DEFAULT	4	2	Climb	MaxTakeoff	25	1 000			
MD11GE	DEFAULT	4	3	Accelerate	MaxTakeoff	0/EXT		1 500	209	
MD11GE	DEFAULT	4	4	Climb	MaxClimb	0/EXT	2 000			
MD11GE	DEFAULT	4	5	Climb	MaxClimb	0/EXT	3 000			
MD11GE	DEFAULT	4	6	Accelerate	MaxClimb	0/RET		1 500	250	
MD11GE	DEFAULT	4	7	Climb	MaxClimb	0/RET	10 000			
MD11GE	DEFAULT	5	1	Takeoff	MaxTakeoff	25				
MD11GE	DEFAULT	5	2	Climb	MaxTakeoff	25	1 000			
MD11GE	DEFAULT	5	3	Accelerate	MaxTakeoff	0/EXT		1 500	208	
MD11GE	DEFAULT	5	4	Climb	MaxClimb	0/EXT	2 000			
MD11GE	DEFAULT	5	5	Climb	MaxClimb	0/EXT	3 000			
MD11GE	DEFAULT	5	6	Accelerate	MaxClimb	0/RET		1 500	250	
MD11GE	DEFAULT	5	7	Climb	MaxClimb	0/RET	10 000			
MD11GE	DEFAULT	6	1	Takeoff	MaxTakeoff	25				
MD11GE	DEFAULT	6	2	Climb	MaxTakeoff	25	1 000			
MD11GE	DEFAULT	6	3	Accelerate	MaxTakeoff	0/EXT		1 500	208	
MD11GE	DEFAULT	6	4	Climb	MaxClimb	0/EXT	2 000			
MD11GE	DEFAULT	6	5	Climb	MaxClimb	0/EXT	3 000			
MD11GE	DEFAULT	6	6	Accelerate	MaxClimb	0/RET		1 500	250	
MD11GE	DEFAULT	6	7	Climb	MaxClimb	0/RET	10 000			

ACFTID	Profile_ID	Stage Length	Step Number	Step Type	Thrust Rating	Flap_ID	End Point Altitude (ft)	Rate Of Climb (ft/min)	End Point CAS (kt)	Accelerate_Percent (%)
MD11GE	DEFAULT	7	1	Takeoff	MaxTakeoff	25				
MD11GE	DEFAULT	7	2	Climb	MaxTakeoff	25	1 000			
MD11GE	DEFAULT	7	3	Accelerate	MaxTakeoff	0/EXT		1 500	207	
MD11GE	DEFAULT	7	4	Climb	MaxClimb	0/EXT	2 000			
MD11GE	DEFAULT	7	5	Climb	MaxClimb	0/EXT	3 000			
MD11GE	DEFAULT	7	6	Accelerate	MaxClimb	0/RET		1 500	250	
MD11GE	DEFAULT	7	7	Climb	MaxClimb	0/RET	10 000			
MD11PW	DEFAULT	1	1	Takeoff	MaxTakeoff	25				
MD11PW	DEFAULT	1	2	Climb	MaxTakeoff	25	1 000			
MD11PW	DEFAULT	1	3	Accelerate	MaxTakeoff	0/EXT		1 500	206	
MD11PW	DEFAULT	1	4	Climb	MaxClimb	0/EXT	2 000			
MD11PW	DEFAULT	1	5	Climb	MaxClimb	0/EXT	3 000			
MD11PW	DEFAULT	1	6	Accelerate	MaxClimb	0/RET		1 500	250	
MD11PW	DEFAULT	1	7	Climb	MaxClimb	0/RET	10 000			
MD11PW	DEFAULT	2	1	Takeoff	MaxTakeoff	25				
MD11PW	DEFAULT	2	2	Climb	MaxTakeoff	25	1 000			
MD11PW	DEFAULT	2	3	Accelerate	MaxTakeoff	0/EXT		1 500	206	
MD11PW	DEFAULT	2	4	Climb	MaxClimb	0/EXT	2 000			
MD11PW	DEFAULT	2	5	Climb	MaxClimb	0/EXT	3 000			
MD11PW	DEFAULT	2	6	Accelerate	MaxClimb	0/RET		1 500	250	

ACFTID	Profile_ID	Stage Length	Step Number	Step Type	Thrust Rating	Flap_ID	End Point Altitude (ft)	Rate Of Climb (ft/min)	End Point CAS (kt)	Accelerate_Percent (%)
MD11PW	DEFAULT	2	7	Climb	MaxClimb	0/RET	10 000			
MD11PW	DEFAULT	3	1	Takeoff	MaxTakeoff	25				
MD11PW	DEFAULT	3	2	Climb	MaxTakeoff	25	1 000			
MD11PW	DEFAULT	3	3	Accelerate	MaxTakeoff	0/EXT		1 500	205	
MD11PW	DEFAULT	3	4	Climb	MaxClimb	0/EXT	2 000			
MD11PW	DEFAULT	3	5	Climb	MaxClimb	0/EXT	3 000			
MD11PW	DEFAULT	3	6	Accelerate	MaxClimb	0/RET		1 500	250	
MD11PW	DEFAULT	3	7	Climb	MaxClimb	0/RET	10 000			
MD11PW	DEFAULT	4	1	Takeoff	MaxTakeoff	25				
MD11PW	DEFAULT	4	2	Climb	MaxTakeoff	25	1 000			
MD11PW	DEFAULT	4	3	Accelerate	MaxTakeoff	0/EXT		1 500	205	
MD11PW	DEFAULT	4	4	Climb	MaxClimb	0/EXT	2 000			
MD11PW	DEFAULT	4	5	Climb	MaxClimb	0/EXT	3 000			
MD11PW	DEFAULT	4	6	Accelerate	MaxClimb	0/RET		1 500	250	
MD11PW	DEFAULT	4	7	Climb	MaxClimb	0/RET	10 000			
MD11PW	DEFAULT	5	1	Takeoff	MaxTakeoff	25				
MD11PW	DEFAULT	5	2	Climb	MaxTakeoff	25	1 000			
MD11PW	DEFAULT	5	3	Accelerate	MaxTakeoff	0/EXT		1 500	205	
MD11PW	DEFAULT	5	4	Climb	MaxClimb	0/EXT	2 000			
MD11PW	DEFAULT	5	5	Climb	MaxClimb	0/EXT	3 000			

ACFTID	Profile_ID	Stage Length	Step Number	Step Type	Thrust Rating	Flap_ID	End Point Altitude (ft)	Rate Of Climb (ft/min)	End Point CAS (kt)	Accelerate_Percent (%)
MD11PW	DEFAULT	5	6	Accelerate	MaxClimb	0/RET		1 500	250	
MD11PW	DEFAULT	5	7	Climb	MaxClimb	0/RET	10 000			
MD11PW	DEFAULT	6	1	Takeoff	MaxTakeoff	25				
MD11PW	DEFAULT	6	2	Climb	MaxTakeoff	25	1 000			
MD11PW	DEFAULT	6	3	Accelerate	MaxTakeoff	0/EXT		1 500	206	
MD11PW	DEFAULT	6	4	Climb	MaxClimb	0/EXT	2 000			
MD11PW	DEFAULT	6	5	Climb	MaxClimb	0/EXT	3 000			
MD11PW	DEFAULT	6	6	Accelerate	MaxClimb	0/RET		1 500	250	
MD11PW	DEFAULT	6	7	Climb	MaxClimb	0/RET	10 000			
MD11PW	DEFAULT	7	1	Takeoff	MaxTakeoff	25				
MD11PW	DEFAULT	7	2	Climb	MaxTakeoff	25	1 000			
MD11PW	DEFAULT	7	3	Accelerate	MaxTakeoff	0/EXT		1 500	207	
MD11PW	DEFAULT	7	4	Climb	MaxClimb	0/EXT	2 000			
MD11PW	DEFAULT	7	5	Climb	MaxClimb	0/EXT	3 000			
MD11PW	DEFAULT	7	6	Accelerate	MaxClimb	0/RET		1 500	250	
MD11PW	DEFAULT	7	7	Climb	MaxClimb	0/RET	10 000			
MD81	DEFAULT	1	1	Takeoff	MaxTakeoff	T_15				
MD81	DEFAULT	1	2	Climb	MaxTakeoff	T_15	1 000			
MD81	DEFAULT	1	3	Accelerate	MaxClimb	T_INT		1 434,2	214,1	
MD81	DEFAULT	1	4	Climb	MaxClimb	T_ZERO	3 000			

ACFTID	Profile_ID	Stage Length	Step Number	Step Type	Thrust Rating	Flap_ID	End Point Altitude (ft)	Rate Of Climb (ft/min)	End Point CAS (kt)	Accelerate_Percent (%)
MD81	DEFAULT	1	5	Accelerate	MaxClimb	T_ZERO		1 866,9	250	
MD81	DEFAULT	1	6	Climb	MaxClimb	T_ZERO	5 500			
MD81	DEFAULT	1	7	Climb	MaxClimb	T_ZERO	7 500			
MD81	DEFAULT	1	8	Climb	MaxClimb	T_ZERO	10 000			
MD81	DEFAULT	2	1	Takeoff	MaxTakeoff	T_15				
MD81	DEFAULT	2	2	Climb	MaxTakeoff	T_15	1 000			
MD81	DEFAULT	2	3	Accelerate	MaxClimb	T_INT		1 346,9	218,7	
MD81	DEFAULT	2	4	Climb	MaxClimb	T_ZERO	3 000			
MD81	DEFAULT	2	5	Accelerate	MaxClimb	T_ZERO		1 745	250	
MD81	DEFAULT	2	6	Climb	MaxClimb	T_ZERO	5 500			
MD81	DEFAULT	2	7	Climb	MaxClimb	T_ZERO	7 500			
MD81	DEFAULT	2	8	Climb	MaxClimb	T_ZERO	10 000			
MD81	DEFAULT	3	1	Takeoff	MaxTakeoff	T_15				
MD81	DEFAULT	3	2	Climb	MaxTakeoff	T_15	1 000			
MD81	DEFAULT	3	3	Accelerate	MaxClimb	T_INT		1 266	223,2	
MD81	DEFAULT	3	4	Climb	MaxClimb	T_ZERO	3 000			
MD81	DEFAULT	3	5	Accelerate	MaxClimb	T_ZERO		1 643,2	250	
MD81	DEFAULT	3	6	Climb	MaxClimb	T_ZERO	5 500			
MD81	DEFAULT	3	7	Climb	MaxClimb	T_ZERO	7 500			
MD81	DEFAULT	3	8	Climb	MaxClimb	T_ZERO	10 000			

ACFTID	Profile_ID	Stage Length	Step Number	Step Type	Thrust Rating	Flap_ID	End Point Altitude (ft)	Rate Of Climb (ft/min)	End Point CAS (kt)	Accelerate_Percent (%)
MD81	DEFAULT	4	1	Takeoff	MaxTakeoff	T_15				
MD81	DEFAULT	4	2	Climb	MaxTakeoff	T_15	1 000			
MD81	DEFAULT	4	3	Accelerate	MaxClimb	T_INT		1 211,7	226,3	
MD81	DEFAULT	4	4	Climb	MaxClimb	T_ZERO	3 000			
MD81	DEFAULT	4	5	Accelerate	MaxClimb	T_ZERO		1 577,9	250	
MD81	DEFAULT	4	6	Climb	MaxClimb	T_ZERO	5 500			
MD81	DEFAULT	4	7	Climb	MaxClimb	T_ZERO	7 500			
MD81	DEFAULT	4	8	Climb	MaxClimb	T_ZERO	10 000			
MD81	ICAO_A	1	1	Takeoff	MaxTakeoff	T_15				
MD81	ICAO_A	1	2	Climb	MaxTakeoff	T_15	1 500			
MD81	ICAO_A	1	3	Climb	MaxClimb	T_15	3 000			
MD81	ICAO_A	1	4	Accelerate	MaxClimb	T_ZERO		1 169,8	250	
MD81	ICAO_A	1	5	Climb	MaxClimb	T_ZERO	5 500			
MD81	ICAO_A	1	6	Climb	MaxClimb	T_ZERO	7 500			
MD81	ICAO_A	1	7	Climb	MaxClimb	T_ZERO	10 000			
MD81	ICAO_A	2	1	Takeoff	MaxTakeoff	T_15				
MD81	ICAO_A	2	2	Climb	MaxTakeoff	T_15	1 500			
MD81	ICAO_A	2	3	Climb	MaxClimb	T_15	3 000			
MD81	ICAO_A	2	4	Accelerate	MaxClimb	T_ZERO		1 089,3	250	
MD81	ICAO_A	2	5	Climb	MaxClimb	T_ZERO	5 500			

ACFTID	Profile_ID	Stage Length	Step Number	Step Type	Thrust Rating	Flap_ID	End Point Altitude (ft)	Rate Of Climb (ft/min)	End Point CAS (kt)	Accelerate_Percent (%)
MD81	ICAO_A	2	6	Climb	MaxClimb	T_ZERO	7 500			
MD81	ICAO_A	2	7	Climb	MaxClimb	T_ZERO	10 000			
MD81	ICAO_A	3	1	Takeoff	MaxTakeoff	T_15				
MD81	ICAO_A	3	2	Climb	MaxTakeoff	T_15	1 500			
MD81	ICAO_A	3	3	Climb	MaxClimb	T_15	3 000			
MD81	ICAO_A	3	4	Accelerate	MaxClimb	T_ZERO		1 049,8	250	
MD81	ICAO_A	3	5	Climb	MaxClimb	T_ZERO	5 500			
MD81	ICAO_A	3	6	Climb	MaxClimb	T_ZERO	7 500			
MD81	ICAO_A	3	7	Climb	MaxClimb	T_ZERO	10 000			
MD81	ICAO_A	4	1	Takeoff	MaxTakeoff	T_15				
MD81	ICAO_A	4	2	Climb	MaxTakeoff	T_15	1 500			
MD81	ICAO_A	4	3	Climb	MaxClimb	T_15	3 000			
MD81	ICAO_A	4	4	Accelerate	MaxClimb	T_ZERO		998,8	250	
MD81	ICAO_A	4	5	Climb	MaxClimb	T_ZERO	5 500			
MD81	ICAO_A	4	6	Climb	MaxClimb	T_ZERO	7 500			
MD81	ICAO_A	4	7	Climb	MaxClimb	T_ZERO	10 000			
MD81	ICAO_B	1	1	Takeoff	MaxTakeoff	T_15				
MD81	ICAO_B	1	2	Climb	MaxTakeoff	T_15	1 000			
MD81	ICAO_B	1	3	Accelerate	MaxTakeoff	T_INT		1 434,8	218,8	
MD81	ICAO_B	1	4	Climb	MaxClimb	T_ZERO	3 000			

ACFTID	Profile_ID	Stage Length	Step Number	Step Type	Thrust Rating	Flap_ID	End Point Altitude (ft)	Rate Of Climb (ft/min)	End Point CAS (kt)	Accelerate_Percent (%)
MD81	ICAO_B	1	5	Accelerate	MaxClimb	T_ZERO		1 900,5	250	
MD81	ICAO_B	1	6	Climb	MaxClimb	T_ZERO	5 500			
MD81	ICAO_B	1	7	Climb	MaxClimb	T_ZERO	7 500			
MD81	ICAO_B	1	8	Climb	MaxClimb	T_ZERO	10 000			
MD81	ICAO_B	2	1	Takeoff	MaxTakeoff	T_15				
MD81	ICAO_B	2	2	Climb	MaxTakeoff	T_15	1 000			
MD81	ICAO_B	2	3	Accelerate	MaxTakeoff	T_INT		1 345,2	223	
MD81	ICAO_B	2	4	Climb	MaxClimb	T_ZERO	3 000			
MD81	ICAO_B	2	5	Accelerate	MaxClimb	T_ZERO		1 779,8	250	
MD81	ICAO_B	2	6	Climb	MaxClimb	T_ZERO	5 500			
MD81	ICAO_B	2	7	Climb	MaxClimb	T_ZERO	7 500			
MD81	ICAO_B	2	8	Climb	MaxClimb	T_ZERO	10 000			
MD81	ICAO_B	3	1	Takeoff	MaxTakeoff	T_15				
MD81	ICAO_B	3	2	Climb	MaxTakeoff	T_15	1 000			
MD81	ICAO_B	3	3	Accelerate	MaxTakeoff	T_INT		1 264,5	227,4	
MD81	ICAO_B	3	4	Climb	MaxClimb	T_ZERO	3 000			
MD81	ICAO_B	3	5	Accelerate	MaxClimb	T_ZERO		1 664,2	250	
MD81	ICAO_B	3	6	Climb	MaxClimb	T_ZERO	5 500			
MD81	ICAO_B	3	7	Climb	MaxClimb	T_ZERO	7 500			
MD81	ICAO_B	3	8	Climb	MaxClimb	T_ZERO	10 000			

ACFTID	Profile_ID	Stage Length	Step Number	Step Type	Thrust Rating	Flap_ID	End Point Altitude (ft)	Rate Of Climb (ft/min)	End Point CAS (kt)	Accelerate_Percent (%)
MD81	ICAO_B	4	1	Takeoff	MaxTakeoff	T_15				
MD81	ICAO_B	4	2	Climb	MaxTakeoff	T_15	1 000			
MD81	ICAO_B	4	3	Accelerate	MaxTakeoff	T_INT		1 211,1	230,2	
MD81	ICAO_B	4	4	Climb	MaxClimb	T_ZERO	3 000			
MD81	ICAO_B	4	5	Accelerate	MaxClimb	T_ZERO		1 594,3	250	
MD81	ICAO_B	4	6	Climb	MaxClimb	T_ZERO	5 500			
MD81	ICAO_B	4	7	Climb	MaxClimb	T_ZERO	7 500			
MD81	ICAO_B	4	8	Climb	MaxClimb	T_ZERO	10 000			
MD82	DEFAULT	1	1	Takeoff	MaxTakeoff	T_15				
MD82	DEFAULT	1	2	Climb	MaxTakeoff	T_15	1 000			
MD82	DEFAULT	1	3	Accelerate	MaxClimb	INT4		1 247,7	216,4	
MD82	DEFAULT	1	4	Climb	MaxClimb	INT3	3 000			
MD82	DEFAULT	1	5	Accelerate	MaxClimb	T_ZERO		1 933	250	
MD82	DEFAULT	1	6	Climb	MaxClimb	T_ZERO	5 500			
MD82	DEFAULT	1	7	Climb	MaxClimb	T_ZERO	7 500			
MD82	DEFAULT	1	8	Climb	MaxClimb	T_ZERO	10 000			
MD82	DEFAULT	2	1	Takeoff	MaxTakeoff	T_15				
MD82	DEFAULT	2	2	Climb	MaxTakeoff	T_15	1 000			
MD82	DEFAULT	2	3	Accelerate	MaxClimb	INT4		1 169,5	220,7	
MD82	DEFAULT	2	4	Climb	MaxClimb	INT3	3 000			

ACFTID	Profile_ID	Stage Length	Step Number	Step Type	Thrust Rating	Flap_ID	End Point Altitude (ft)	Rate Of Climb (ft/min)	End Point CAS (kt)	Accelerate_Percent (%)
MD82	DEFAULT	2	5	Accelerate	MaxClimb	T_ZERO		1 805,5	250	
MD82	DEFAULT	2	6	Climb	MaxClimb	T_ZERO	5 500			
MD82	DEFAULT	2	7	Climb	MaxClimb	T_ZERO	7 500			
MD82	DEFAULT	2	8	Climb	MaxClimb	T_ZERO	10 000			
MD82	DEFAULT	3	1	Takeoff	MaxTakeoff	T_15				
MD82	DEFAULT	3	2	Climb	MaxTakeoff	T_15	1 000			
MD82	DEFAULT	3	3	Accelerate	MaxClimb	INT4		1 099,1	225,1	
MD82	DEFAULT	3	4	Climb	MaxClimb	INT3	3 000			
MD82	DEFAULT	3	5	Accelerate	MaxClimb	T_ZERO		1 710,9	250	
MD82	DEFAULT	3	6	Climb	MaxClimb	T_ZERO	5 500			
MD82	DEFAULT	3	7	Climb	MaxClimb	T_ZERO	7 500			
MD82	DEFAULT	3	8	Climb	MaxClimb	T_ZERO	10 000			
MD82	DEFAULT	4	1	Takeoff	MaxTakeoff	T_15				
MD82	DEFAULT	4	2	Climb	MaxTakeoff	T_15	1 000			
MD82	DEFAULT	4	3	Accelerate	MaxClimb	INT4		989,5	231,9	
MD82	DEFAULT	4	4	Climb	MaxClimb	INT3	3 000			
MD82	DEFAULT	4	5	Accelerate	MaxClimb	T_ZERO		1 563,6	250	
MD82	DEFAULT	4	6	Climb	MaxClimb	T_ZERO	5 500			
MD82	DEFAULT	4	7	Climb	MaxClimb	T_ZERO	7 500			
MD82	DEFAULT	4	8	Climb	MaxClimb	T_ZERO	10 000			

ACFTID	Profile_ID	Stage Length	Step Number	Step Type	Thrust Rating	Flap_ID	End Point Altitude (ft)	Rate Of Climb (ft/min)	End Point CAS (kt)	Accelerate_Percent (%)
MD82	DEFAULT	5	1	Takeoff	MaxTakeoff	T_15				
MD82	DEFAULT	5	2	Climb	MaxTakeoff	T_15	1 000			
MD82	DEFAULT	5	3	Accelerate	MaxClimb	INT4		950,4	234,2	
MD82	DEFAULT	5	4	Climb	MaxClimb	INT3	3 000			
MD82	DEFAULT	5	5	Accelerate	MaxClimb	T_ZERO		1 518,1	250	
MD82	DEFAULT	5	6	Climb	MaxClimb	T_ZERO	5 500			
MD82	DEFAULT	5	7	Climb	MaxClimb	T_ZERO	7 500			
MD82	DEFAULT	5	8	Climb	MaxClimb	T_ZERO	10 000			
MD82	ICAO_A	1	1	Takeoff	MaxTakeoff	T_15				
MD82	ICAO_A	1	2	Climb	MaxTakeoff	T_15	1 500			
MD82	ICAO_A	1	3	Climb	MaxClimb	T_INT	3 000			
MD82	ICAO_A	1	4	Accelerate	MaxClimb	T_ZERO		1 200	250	
MD82	ICAO_A	1	5	Climb	MaxClimb	T_ZERO	5 500			
MD82	ICAO_A	1	6	Climb	MaxClimb	T_ZERO	7 500			
MD82	ICAO_A	1	7	Climb	MaxClimb	T_ZERO	10 000			
MD82	ICAO_A	2	1	Takeoff	MaxTakeoff	T_15				
MD82	ICAO_A	2	2	Climb	MaxTakeoff	T_15	1 500			
MD82	ICAO_A	2	3	Climb	MaxClimb	T_15	3 000			
MD82	ICAO_A	2	4	Accelerate	MaxClimb	T_ZERO		1 120,6	250	
MD82	ICAO_A	2	5	Climb	MaxClimb	T_ZERO	5 500			

ACFTID	Profile_ID	Stage Length	Step Number	Step Type	Thrust Rating	Flap_ID	End Point Altitude (ft)	Rate Of Climb (ft/min)	End Point CAS (kt)	Accelerate_Percent (%)
MD82	ICAO_A	2	6	Climb	MaxClimb	T_ZERO	7 500			
MD82	ICAO_A	2	7	Climb	MaxClimb	T_ZERO	10 000			
MD82	ICAO_A	3	1	Takeoff	MaxTakeoff	T_15				
MD82	ICAO_A	3	2	Climb	MaxTakeoff	T_15	1 500			
MD82	ICAO_A	3	3	Climb	MaxClimb	T_15	3 000			
MD82	ICAO_A	3	4	Accelerate	MaxClimb	T_ZERO		1 051,4	250	
MD82	ICAO_A	3	5	Climb	MaxClimb	T_ZERO	5 500			
MD82	ICAO_A	3	6	Climb	MaxClimb	T_ZERO	7 500			
MD82	ICAO_A	3	7	Climb	MaxClimb	T_ZERO	10 000			
MD82	ICAO_A	4	1	Takeoff	MaxTakeoff	T_15				
MD82	ICAO_A	4	2	Climb	MaxTakeoff	T_15	1 500			
MD82	ICAO_A	4	3	Climb	MaxClimb	T_15	3 000			
MD82	ICAO_A	4	4	Accelerate	MaxClimb	T_ZERO		939,4	250	
MD82	ICAO_A	4	5	Climb	MaxClimb	T_ZERO	5 500			
MD82	ICAO_A	4	6	Climb	MaxClimb	T_ZERO	7 500			
MD82	ICAO_A	4	7	Climb	MaxClimb	T_ZERO	10 000			
MD82	ICAO_A	5	1	Takeoff	MaxTakeoff	T_15				
MD82	ICAO_A	5	2	Climb	MaxTakeoff	T_15	1 500			
MD82	ICAO_A	5	3	Climb	MaxClimb	T_15	3 000			
MD82	ICAO_A	5	4	Accelerate	MaxClimb	T_ZERO		900	250	

ACFTID	Profile_ID	Stage Length	Step Number	Step Type	Thrust Rating	Flap_ID	End Point Altitude (ft)	Rate Of Climb (ft/min)	End Point CAS (kt)	Accelerate_Percent (%)
MD82	ICAO_A	5	5	Climb	MaxClimb	T_ZERO	5 500			
MD82	ICAO_A	5	6	Climb	MaxClimb	T_ZERO	7 500			
MD82	ICAO_A	5	7	Climb	MaxClimb	T_ZERO	10 000			
MD82	ICAO_B	1	1	Takeoff	MaxTakeoff	T_15				
MD82	ICAO_B	1	2	Climb	MaxTakeoff	T_15	1 000			
MD82	ICAO_B	1	3	Accelerate	MaxTakeoff	T_INT		1 447,7	218,7	
MD82	ICAO_B	1	4	Climb	MaxClimb	T_ZERO	3 000			
MD82	ICAO_B	1	5	Accelerate	MaxClimb	T_ZERO		1 952,8	250	
MD82	ICAO_B	1	6	Climb	MaxClimb	T_ZERO	5 500			
MD82	ICAO_B	1	7	Climb	MaxClimb	T_ZERO	7 500			
MD82	ICAO_B	1	8	Climb	MaxClimb	T_ZERO	10 000			
MD82	ICAO_B	2	1	Takeoff	MaxTakeoff	T_15				
MD82	ICAO_B	2	2	Climb	MaxTakeoff	T_15	1 000			
MD82	ICAO_B	2	3	Accelerate	MaxTakeoff	T_INT		1 360,4	222,9	
MD82	ICAO_B	2	4	Climb	MaxClimb	T_ZERO	3 000			
MD82	ICAO_B	2	5	Accelerate	MaxClimb	T_ZERO		1 838,2	250	
MD82	ICAO_B	2	6	Climb	MaxClimb	T_ZERO	5 500			
MD82	ICAO_B	2	7	Climb	MaxClimb	T_ZERO	7 500			
MD82	ICAO_B	2	8	Climb	MaxClimb	T_ZERO	10 000			
MD82	ICAO_B	3	1	Takeoff	MaxTakeoff	T_15				

ACFTID	Profile_ID	Stage Length	Step Number	Step Type	Thrust Rating	Flap_ID	End Point Altitude (ft)	Rate Of Climb (ft/min)	End Point CAS (kt)	Accelerate_Percent (%)
MD82	ICAO_B	3	2	Climb	MaxTakeoff	T_15	1 000			
MD82	ICAO_B	3	3	Accelerate	MaxTakeoff	T_INT		1 279,8	227,2	
MD82	ICAO_B	3	4	Climb	MaxClimb	T_ZERO	3 000			
MD82	ICAO_B	3	5	Accelerate	MaxClimb	T_ZERO		1 732,3	250	
MD82	ICAO_B	3	6	Climb	MaxClimb	T_ZERO	5 500			
MD82	ICAO_B	3	7	Climb	MaxClimb	T_ZERO	7 500			
MD82	ICAO_B	3	8	Climb	MaxClimb	T_ZERO	10 000			
MD82	ICAO_B	4	1	Takeoff	MaxTakeoff	T_15				
MD82	ICAO_B	4	2	Climb	MaxTakeoff	T_15	1 000			
MD82	ICAO_B	4	3	Accelerate	MaxTakeoff	T_INT		1 160,8	233,9	
MD82	ICAO_B	4	4	Climb	MaxClimb	T_ZERO	3 000			
MD82	ICAO_B	4	5	Accelerate	MaxClimb	T_ZERO		1 564,9	250	
MD82	ICAO_B	4	6	Climb	MaxClimb	T_ZERO	5 500			
MD82	ICAO_B	4	7	Climb	MaxClimb	T_ZERO	7 500			
MD82	ICAO_B	4	8	Climb	MaxClimb	T_ZERO	10 000			
MD82	ICAO_B	5	1	Takeoff	MaxTakeoff	T_15				
MD82	ICAO_B	5	2	Climb	MaxTakeoff	T_15	1 000			
MD82	ICAO_B	5	3	Accelerate	MaxTakeoff	T_INT		1 131,1	236,1	
MD82	ICAO_B	5	4	Climb	MaxClimb	T_ZERO	3 000			
MD82	ICAO_B	5	5	Accelerate	MaxClimb	T_ZERO		1 522,4	250	

ACFTID	Profile_ID	Stage Length	Step Number	Step Type	Thrust Rating	Flap_ID	End Point Altitude (ft)	Rate Of Climb (ft/min)	End Point CAS (kt)	Accelerate_Percent (%)
MD82	ICAO_B	5	6	Climb	MaxClimb	T_ZERO	5 500			
MD82	ICAO_B	5	7	Climb	MaxClimb	T_ZERO	7 500			
MD82	ICAO_B	5	8	Climb	MaxClimb	T_ZERO	10 000			
MD83	DEFAULT	1	1	Takeoff	MaxTakeoff	T_15				
MD83	DEFAULT	1	2	Climb	MaxTakeoff	T_15	1 000			
MD83	DEFAULT	1	3	Accelerate	MaxClimb	T_INT		1 319	218,1	
MD83	DEFAULT	1	4	Climb	MaxClimb	T_ZERO	3 000			
MD83	DEFAULT	1	5	Accelerate	MaxClimb	T_ZERO		2 033,2	250	
MD83	DEFAULT	1	6	Climb	MaxClimb	T_ZERO	5 500			
MD83	DEFAULT	1	7	Climb	MaxClimb	T_ZERO	7 500			
MD83	DEFAULT	1	8	Climb	MaxClimb	T_ZERO	10 000			
MD83	DEFAULT	2	1	Takeoff	MaxTakeoff	T_15				
MD83	DEFAULT	2	2	Climb	MaxTakeoff	T_15	1 000			
MD83	DEFAULT	2	3	Accelerate	MaxClimb	T_INT		1 239,2	222,2	
MD83	DEFAULT	2	4	Climb	MaxClimb	T_ZERO	3 000			
MD83	DEFAULT	2	5	Accelerate	MaxClimb	T_ZERO		1 921,8	250	
MD83	DEFAULT	2	6	Climb	MaxClimb	T_ZERO	5 500			
MD83	DEFAULT	2	7	Climb	MaxClimb	T_ZERO	7 500			
MD83	DEFAULT	2	8	Climb	MaxClimb	T_ZERO	10 000			
MD83	DEFAULT	3	1	Takeoff	MaxTakeoff	T_15				

ACFTID	Profile_ID	Stage Length	Step Number	Step Type	Thrust Rating	Flap_ID	End Point Altitude (ft)	Rate Of Climb (ft/min)	End Point CAS (kt)	Accelerate_Percent (%)
MD83	DEFAULT	3	2	Climb	MaxTakeoff	T_15	1 000			
MD83	DEFAULT	3	3	Accelerate	MaxClimb	T_INT		1 158,7	226,6	
MD83	DEFAULT	3	4	Climb	MaxClimb	T_ZERO	3 000			
MD83	DEFAULT	3	5	Accelerate	MaxClimb	T_ZERO		1 810	250	
MD83	DEFAULT	3	6	Climb	MaxClimb	T_ZERO	5 500			
MD83	DEFAULT	3	7	Climb	MaxClimb	T_ZERO	7 500			
MD83	DEFAULT	3	8	Climb	MaxClimb	T_ZERO	10 000			
MD83	DEFAULT	4	1	Takeoff	MaxTakeoff	T_15				
MD83	DEFAULT	4	2	Climb	MaxTakeoff	T_15	1 000			
MD83	DEFAULT	4	3	Accelerate	MaxClimb	T_INT		1 049,7	233,6	
MD83	DEFAULT	4	4	Climb	MaxClimb	T_ZERO	3 000			
MD83	DEFAULT	4	5	Accelerate	MaxClimb	T_ZERO		1 649	250	
MD83	DEFAULT	4	6	Climb	MaxClimb	T_ZERO	5 500			
MD83	DEFAULT	4	7	Climb	MaxClimb	T_ZERO	7 500			
MD83	DEFAULT	4	8	Climb	MaxClimb	T_ZERO	10 000			
MD83	DEFAULT	5	1	Takeoff	MaxTakeoff	T_15				
MD83	DEFAULT	5	2	Climb	MaxTakeoff	T_15	1 000			
MD83	DEFAULT	5	3	Accelerate	MaxClimb	T_INT		929,7	241,3	
MD83	DEFAULT	5	4	Climb	MaxClimb	T_ZERO	3 000			
MD83	DEFAULT	5	5	Accelerate	MaxClimb	T_ZERO		1 482,4	250	

ACFTID	Profile_ID	Stage Length	Step Number	Step Type	Thrust Rating	Flap_ID	End Point Altitude (ft)	Rate Of Climb (ft/min)	End Point CAS (kt)	Accelerate_Percent (%)
MD83	DEFAULT	5	6	Climb	MaxClimb	T_ZERO	5 500			
MD83	DEFAULT	5	7	Climb	MaxClimb	T_ZERO	7 500			
MD83	DEFAULT	5	8	Climb	MaxClimb	T_ZERO	10 000			
MD83	ICAO_A	1	1	Takeoff	MaxTakeoff	T_15				
MD83	ICAO_A	1	2	Climb	MaxTakeoff	T_15	1 500			
MD83	ICAO_A	1	3	Climb	MaxClimb	T_15	3 000			
MD83	ICAO_A	1	4	Accelerate	MaxClimb	T_INT		1 269,6	250	
MD83	ICAO_A	1	5	Climb	MaxClimb	T_ZERO	5 500			
MD83	ICAO_A	1	6	Climb	MaxClimb	T_ZERO	7 500			
MD83	ICAO_A	1	7	Climb	MaxClimb	T_ZERO	10 000			
MD83	ICAO_A	2	1	Takeoff	MaxTakeoff	T_15				
MD83	ICAO_A	2	2	Climb	MaxTakeoff	T_15	1 500			
MD83	ICAO_A	2	3	Climb	MaxClimb	T_15	3 000			
MD83	ICAO_A	2	4	Accelerate	MaxClimb	T_INT		1 188,7	250	
MD83	ICAO_A	2	5	Climb	MaxClimb	T_ZERO	5 500			
MD83	ICAO_A	2	6	Climb	MaxClimb	T_ZERO	7 500			
MD83	ICAO_A	2	7	Climb	MaxClimb	T_ZERO	10 000			
MD83	ICAO_A	3	1	Takeoff	MaxTakeoff	T_15				
MD83	ICAO_A	3	2	Climb	MaxTakeoff	T_15	1 500			
MD83	ICAO_A	3	3	Climb	MaxClimb	T_15	3 000			

ACFTID	Profile_ID	Stage Length	Step Number	Step Type	Thrust Rating	Flap_ID	End Point Altitude (ft)	Rate Of Climb (ft/min)	End Point CAS (kt)	Accelerate_Percent (%)
MD83	ICAO_A	3	4	Accelerate	MaxClimb	T_INT		1 109,5	250	
MD83	ICAO_A	3	5	Climb	MaxClimb	T_ZERO	5 500			
MD83	ICAO_A	3	6	Climb	MaxClimb	T_ZERO	7 500			
MD83	ICAO_A	3	7	Climb	MaxClimb	T_ZERO	10 000			
MD83	ICAO_A	4	1	Takeoff	MaxTakeoff	T_15				
MD83	ICAO_A	4	2	Climb	MaxTakeoff	T_15	1 500			
MD83	ICAO_A	4	3	Climb	MaxClimb	T_15	3 000			
MD83	ICAO_A	4	4	Accelerate	MaxClimb	T_INT		989,8	250	
MD83	ICAO_A	4	5	Climb	MaxClimb	T_ZERO	5 500			
MD83	ICAO_A	4	6	Climb	MaxClimb	T_ZERO	7 500			
MD83	ICAO_A	4	7	Climb	MaxClimb	T_ZERO	10 000			
MD83	ICAO_A	5	1	Takeoff	MaxTakeoff	T_15				
MD83	ICAO_A	5	2	Climb	MaxTakeoff	T_15	1 500			
MD83	ICAO_A	5	3	Climb	MaxClimb	T_15	3 000			
MD83	ICAO_A	5	4	Accelerate	MaxClimb	T_INT		880,1	250	
MD83	ICAO_A	5	5	Climb	MaxClimb	T_ZERO	5 500			
MD83	ICAO_A	5	6	Climb	MaxClimb	T_ZERO	7 500			
MD83	ICAO_A	5	7	Climb	MaxClimb	T_ZERO	10 000			
MD83	ICAO_B	1	1	Takeoff	MaxTakeoff	T_15				
MD83	ICAO_B	1	2	Climb	MaxTakeoff	T_15	1 000			

ACFTID	Profile_ID	Stage Length	Step Number	Step Type	Thrust Rating	Flap_ID	End Point Altitude (ft)	Rate Of Climb (ft/min)	End Point CAS (kt)	Accelerate_Percent (%)
MD83	ICAO_B	1	3	Accelerate	MaxTakeoff	T_INT		1 546,8	221,1	
MD83	ICAO_B	1	4	Climb	MaxClimb	T_ZERO	3 000			
MD83	ICAO_B	1	5	Accelerate	MaxClimb	T_ZERO		2 056,2	250	
MD83	ICAO_B	1	6	Climb	MaxClimb	T_ZERO	5 500			
MD83	ICAO_B	1	7	Climb	MaxClimb	T_ZERO	7 500			
MD83	ICAO_B	1	8	Climb	MaxClimb	T_ZERO	10 000			
MD83	ICAO_B	2	1	Takeoff	MaxTakeoff	T_15				
MD83	ICAO_B	2	2	Climb	MaxTakeoff	T_15	1 000			
MD83	ICAO_B	2	3	Accelerate	MaxTakeoff	T_INT		1 462	225,1	
MD83	ICAO_B	2	4	Climb	MaxClimb	T_ZERO	3 000			
MD83	ICAO_B	2	5	Accelerate	MaxClimb	T_ZERO		1 941,6	250	
MD83	ICAO_B	2	6	Climb	MaxClimb	T_ZERO	5 500			
MD83	ICAO_B	2	7	Climb	MaxClimb	T_ZERO	7 500			
MD83	ICAO_B	2	8	Climb	MaxClimb	T_ZERO	10 000			
MD83	ICAO_B	3	1	Takeoff	MaxTakeoff	T_15				
MD83	ICAO_B	3	2	Climb	MaxTakeoff	T_15	1 000			
MD83	ICAO_B	3	3	Accelerate	MaxTakeoff	T_INT		1 376,3	229,2	
MD83	ICAO_B	3	4	Climb	MaxClimb	T_ZERO	3 000			
MD83	ICAO_B	3	5	Accelerate	MaxClimb	T_ZERO		1 837,5	250	
MD83	ICAO_B	3	6	Climb	MaxClimb	T_ZERO	5 500			

ACFTID	Profile_ID	Stage Length	Step Number	Step Type	Thrust Rating	Flap_ID	End Point Altitude (ft)	Rate Of Climb (ft/min)	End Point CAS (kt)	Accelerate_Percent (%)
MD83	ICAO_B	3	7	Climb	MaxClimb	T_ZERO	7 500			
MD83	ICAO_B	3	8	Climb	MaxClimb	T_ZERO	10 000			
MD83	ICAO_B	4	1	Takeoff	MaxTakeoff	T_15				
MD83	ICAO_B	4	2	Climb	MaxTakeoff	T_15	1 000			
MD83	ICAO_B	4	3	Accelerate	MaxTakeoff	T_INT		1 249,5	236,1	
MD83	ICAO_B	4	4	Climb	MaxClimb	T_ZERO	3 000			
MD83	ICAO_B	4	5	Accelerate	MaxClimb	T_ZERO		1 671,1	250	
MD83	ICAO_B	4	6	Climb	MaxClimb	T_ZERO	5 500			
MD83	ICAO_B	4	7	Climb	MaxClimb	T_ZERO	7 500			
MD83	ICAO_B	4	8	Climb	MaxClimb	T_ZERO	10 000			
MD83	ICAO_B	5	1	Takeoff	MaxTakeoff	T_15				
MD83	ICAO_B	5	2	Climb	MaxTakeoff	T_15	1 000			
MD83	ICAO_B	5	3	Accelerate	MaxTakeoff	T_INT		1 130,3	243,6	
MD83	ICAO_B	5	4	Climb	MaxClimb	T_ZERO	3 000			
MD83	ICAO_B	5	5	Accelerate	MaxClimb	T_ZERO		1 504,9	250	
MD83	ICAO_B	5	6	Climb	MaxClimb	T_ZERO	5 500			
MD83	ICAO_B	5	7	Climb	MaxClimb	T_ZERO	7 500			
MD83	ICAO_B	5	8	Climb	MaxClimb	T_ZERO	10 000			
MD9025	DEFAULT	1	1	Takeoff	MaxTakeoff	EXT/11				
MD9025	DEFAULT	1	2	Climb	MaxTakeoff	EXT/11	1 000			

ACFTID	Profile_ID	Stage Length	Step Number	Step Type	Thrust Rating	Flap_ID	End Point Altitude (ft)	Rate Of Climb (ft/min)	End Point CAS (kt)	Accelerate_Percent (%)
MD9025	DEFAULT	1	3	Accelerate	MaxTakeoff	RET/0		2 280	194	
MD9025	DEFAULT	1	4	Climb	MaxClimb	RET/0	3 000			
MD9025	DEFAULT	1	5	Accelerate	MaxClimb	RET/0		1 000	250	
MD9025	DEFAULT	1	6	Climb	MaxClimb	RET/0	10 000			
MD9025	DEFAULT	2	1	Takeoff	MaxTakeoff	EXT/11				
MD9025	DEFAULT	2	2	Climb	MaxTakeoff	EXT/11	1 000			
MD9025	DEFAULT	2	3	Accelerate	MaxTakeoff	RET/0		2 150	193	
MD9025	DEFAULT	2	4	Climb	MaxClimb	RET/0	3 000			
MD9025	DEFAULT	2	5	Accelerate	MaxClimb	RET/0		1 000	250	
MD9025	DEFAULT	2	6	Climb	MaxClimb	RET/0	10 000			
MD9025	DEFAULT	3	1	Takeoff	MaxTakeoff	EXT/11				
MD9025	DEFAULT	3	2	Climb	MaxTakeoff	EXT/11	1 000			
MD9025	DEFAULT	3	3	Accelerate	MaxTakeoff	RET/0		2 031	192	
MD9025	DEFAULT	3	4	Climb	MaxClimb	RET/0	3 000			
MD9025	DEFAULT	3	5	Accelerate	MaxClimb	RET/0		1 000	250	
MD9025	DEFAULT	3	6	Climb	MaxClimb	RET/0	10 000			
MD9025	DEFAULT	4	1	Takeoff	MaxTakeoff	EXT/11				
MD9025	DEFAULT	4	2	Climb	MaxTakeoff	EXT/11	1 000			
MD9025	DEFAULT	4	3	Accelerate	MaxTakeoff	RET/0		1 916	191	
MD9025	DEFAULT	4	4	Climb	MaxClimb	RET/0	3 000			

ACFTID	Profile_ID	Stage Length	Step Number	Step Type	Thrust Rating	Flap_ID	End Point Altitude (ft)	Rate Of Climb (ft/min)	End Point CAS (kt)	Accelerate_Percent (%)
MD9025	DEFAULT	4	5	Accelerate	MaxClimb	RET/0		1 000	250	
MD9025	DEFAULT	4	6	Climb	MaxClimb	RET/0	10 000			
MD9025	DEFAULT	5	1	Takeoff	MaxTakeoff	EXT/11				
MD9025	DEFAULT	5	2	Climb	MaxTakeoff	EXT/11	1 000			
MD9025	DEFAULT	5	3	Accelerate	MaxTakeoff	RET/0		1 840	190	
MD9025	DEFAULT	5	4	Climb	MaxClimb	RET/0	3 000			
MD9025	DEFAULT	5	5	Accelerate	MaxClimb	RET/0		1 000	250	
MD9025	DEFAULT	5	6	Climb	MaxClimb	RET/0	10 000			
MD9028	DEFAULT	1	1	Takeoff	MaxTakeoff	EXT/11				
MD9028	DEFAULT	1	2	Climb	MaxTakeoff	EXT/11	1 000			
MD9028	DEFAULT	1	3	Accelerate	MaxTakeoff	RET/0		2 666	196	
MD9028	DEFAULT	1	4	Climb	MaxClimb	RET/0	3 000			
MD9028	DEFAULT	1	5	Accelerate	MaxClimb	RET/0		1 000	250	
MD9028	DEFAULT	1	6	Climb	MaxClimb	RET/0	10 000			
MD9028	DEFAULT	2	1	Takeoff	MaxTakeoff	EXT/11				
MD9028	DEFAULT	2	2	Climb	MaxTakeoff	EXT/11	1 000			
MD9028	DEFAULT	2	3	Accelerate	MaxTakeoff	RET/0		2 525	194	
MD9028	DEFAULT	2	4	Climb	MaxClimb	RET/0	3 000			
MD9028	DEFAULT	2	5	Accelerate	MaxClimb	RET/0		1 000	250	
MD9028	DEFAULT	2	6	Climb	MaxClimb	RET/0	10 000			

ACFTID	Profile_ID	Stage Length	Step Number	Step Type	Thrust Rating	Flap_ID	End Point Altitude (ft)	Rate Of Climb (ft/min)	End Point CAS (kt)	Accelerate_Percent (%)
MD9028	DEFAULT	3	1	Takeoff	MaxTakeoff	EXT/11				
MD9028	DEFAULT	3	2	Climb	MaxTakeoff	EXT/11	1 000			
MD9028	DEFAULT	3	3	Accelerate	MaxTakeoff	RET/0		2 391	193	
MD9028	DEFAULT	3	4	Climb	MaxClimb	RET/0	3 000			
MD9028	DEFAULT	3	5	Accelerate	MaxClimb	RET/0		1 000	250	
MD9028	DEFAULT	3	6	Climb	MaxClimb	RET/0	10 000			
MD9028	DEFAULT	4	1	Takeoff	MaxTakeoff	EXT/11				
MD9028	DEFAULT	4	2	Climb	MaxTakeoff	EXT/11	1 000			
MD9028	DEFAULT	4	3	Accelerate	MaxTakeoff	RET/0		2 263	192	
MD9028	DEFAULT	4	4	Climb	MaxClimb	RET/0	3 000			
MD9028	DEFAULT	4	5	Accelerate	MaxClimb	RET/0		1 000	250	
MD9028	DEFAULT	4	6	Climb	MaxClimb	RET/0	10 000			
MD9028	DEFAULT	5	1	Takeoff	MaxTakeoff	EXT/11				
MD9028	DEFAULT	5	2	Climb	MaxTakeoff	EXT/11	1 000			
MD9028	DEFAULT	5	3	Accelerate	MaxTakeoff	RET/0		2 180	189	
MD9028	DEFAULT	5	4	Climb	MaxClimb	RET/0	3 000			
MD9028	DEFAULT	5	5	Accelerate	MaxClimb	RET/0		1 000	250	
MD9028	DEFAULT	5	6	Climb	MaxClimb	RET/0	10 000			
MU3001	DEFAULT	1	1	Takeoff	MaxTakeoff	10				
MU3001	DEFAULT	1	2	Accelerate	MaxTakeoff	10		1 130	142	

ACFTID	Profile_ID	Stage Length	Step Number	Step Type	Thrust Rating	Flap_ID	End Point Altitude (ft)	Rate Of Climb (ft/min)	End Point CAS (kt)	Accelerate_Percent (%)
MU3001	DEFAULT	1	3	Climb	MaxTakeoff	1	1 500			
MU3001	DEFAULT	1	4	Accelerate	MaxTakeoff	1		1 130	200	
MU3001	DEFAULT	1	5	Climb	MaxClimb	ZERO	3 000			
MU3001	DEFAULT	1	6	Accelerate	MaxClimb	ZERO		1 555	250	
MU3001	DEFAULT	1	7	Climb	MaxClimb	ZERO	5 500			
MU3001	DEFAULT	1	8	Climb	MaxClimb	ZERO	7 500			
MU3001	DEFAULT	1	9	Climb	MaxClimb	ZERO	10 000			
PA30	DEFAULT	1	1	Takeoff	MaxTakeoff	15-D				
PA30	DEFAULT	1	2	Accelerate	MaxTakeoff	15-D		415	79	
PA30	DEFAULT	1	3	Accelerate	MaxTakeoff	15-D		500	113	
PA30	DEFAULT	1	4	Climb	MaxTakeoff	ZERO-D	1 500			
PA30	DEFAULT	1	5	Climb	MaxTakeoff	ZERO-D	3 000			
PA30	DEFAULT	1	6	Climb	MaxClimb	ZERO-D	5 500			
PA30	DEFAULT	1	7	Climb	MaxClimb	ZERO-D	7 500			
PA30	DEFAULT	1	8	Climb	MaxClimb	ZERO-D	10 000			
PA42	DEFAULT	1	1	Takeoff	MaxTakeoff	ZER-DN				
PA42	DEFAULT	1	2	Accelerate	MaxTakeoff	ZER-DN		1 000	118	
PA42	DEFAULT	1	3	Climb	MaxTakeoff	ZER-DN	1 000			
PA42	DEFAULT	1	4	Accelerate	MaxClimb	ZERO		1 000	154	
PA42	DEFAULT	1	5	Climb	MaxClimb	ZERO	3 000			

ACFTID	Profile_ID	Stage Length	Step Number	Step Type	Thrust Rating	Flap_ID	End Point Altitude (ft)	Rate Of Climb (ft/min)	End Point CAS (kt)	Accelerate_Percent (%)
PA42	DEFAULT	1	6	Climb	MaxClimb	ZERO	4 000			
PA42	DEFAULT	1	7	Climb	MaxClimb	ZERO	6 000			
PA42	DEFAULT	1	8	Climb	MaxClimb	ZERO	8 000			
PA42	DEFAULT	1	9	Climb	MaxClimb	ZERO	10 000			
SD330	DEFAULT	1	1	Takeoff	MaxTakeoff	10				
SD330	DEFAULT	1	2	Climb	MaxTakeoff	10	1 000			
SD330	DEFAULT	1	3	Accelerate	MaxTakeoff	10		971	117	
SD330	DEFAULT	1	4	Accelerate	MaxClimb	INTR		728	137	
SD330	DEFAULT	1	5	Climb	MaxClimb	ZERO	3 000			
SD330	DEFAULT	1	6	Climb	MaxClimb	ZERO	5 500			
SD330	DEFAULT	1	7	Climb	MaxClimb	ZERO	7 500			
SD330	DEFAULT	1	8	Climb	MaxClimb	ZERO	10 000			
SF340	DEFAULT	1	1	Takeoff	MaxTakeoff	15				
SF340	DEFAULT	1	2	Climb	MaxTakeoff	15	1 000			
SF340	DEFAULT	1	3	Accelerate	MaxTakeoff	15		1 821	127	
SF340	DEFAULT	1	4	Accelerate	MaxClimb	5		1 366	147	
SF340	DEFAULT	1	5	Climb	MaxClimb	ZERO	3 000			
SF340	DEFAULT	1	6	Climb	MaxClimb	ZERO	5 500			
SF340	DEFAULT	1	7	Climb	MaxClimb	ZERO	7 500			
SF340	DEFAULT	1	8	Climb	MaxClimb	ZERO	10 000			

ACFTID	Profile_ID	Stage Length	Step Number	Step Type	Thrust Rating	Flap_ID	End Point Altitude (ft)	Rate Of Climb (ft/min)	End Point CAS (kt)	Accelerate_Percent (%)
SF340	DEFAULT	2	1	Takeoff	MaxTakeoff	15				
SF340	DEFAULT	2	2	Climb	MaxTakeoff	15	1 000			
SF340	DEFAULT	2	3	Accelerate	MaxTakeoff	15		1 450	133	
SF340	DEFAULT	2	4	Accelerate	MaxClimb	5		1 088	153	
SF340	DEFAULT	2	5	Climb	MaxClimb	ZERO	3 000			
SF340	DEFAULT	2	6	Climb	MaxClimb	ZERO	5 500			
SF340	DEFAULT	2	7	Climb	MaxClimb	ZERO	7 500			
SF340	DEFAULT	2	8	Climb	MaxClimb	ZERO	10 000			

Table L-5

Default fixed points profiles

ACFTID	Description	Engine type	Numb of Engines	Weight Class	Owner Category	MGTOW (lb)	MCLW (lb)	Max Landing Dist (ft)	Max Sea Level Static Thrust (lb)	Noise Chapter	NPD_ID	Power Parameter	Approach Spectral Class ID	Departure Spectral Class ID	Lateral Directivity Identifier
1900D	Beech 1900D/PT6A67	Turbo-prop	2	Large	Commercial	16 950	14 940	1 696	3 367	1	PT6A67	CNT (lb)	213	109	Prop
707	Boeing 707-120/JT3C	Jet	4	Heavy	Commercial	302 400	188 900	6 682	10 120	1	JT4A	CNT (lb)	208	107	Wing
707120	Boeing 707-120B/JT3D-3	Jet	4	Heavy	Commercial	302 400	188 900	6 893	14 850	1	JT3D	CNT (lb)	208	107	Wing
707320	Boeing 707-320B/JT3D-7	Jet	4	Heavy	Commercial	334 000	247 000	5 622	19 000	1	JT3D	CNT (lb)	208	107	Wing
707QN	Boeing 707-320B/JT3D-7QN	Jet	4	Heavy	Commercial	334 000	247 000	5 622	19 000	2	JT3DQ	CNT (lb)	208	106	Wing
717200	Boeing 717-200/BR 715	Jet	2	Large	Commercial	121 000	110 000	4 600	18 000	3	BR715	CNT (lb)	203	105	Fuselage
720	Boeing 720/JT3C	Jet	4	Large	Commercial	223 500	155 600	4 871	10 120	1	JT4A	CNT (lb)	208	107	Wing
720B	Boeing 720B/JT3D-3	Jet	4	Large	Commercial	234 000	175 000	5 717	18 000	1	JT3D	CNT (lb)	208	107	Wing
727100	Boeing 727-100/JT8D-7	Jet	3	Large	Commercial	169 500	142 500	4 867	14 000	1	3JT8D	CNT (lb)	201	101	Fuselage
727200	Boeing 727-200/JT8D-7	Jet	3	Large	Commercial	217 600	163 300	5 571	11 895	1	3JT8D	CNT (lb)	201	101	Fuselage
727D15	Boeing 727-200/JT8D-15	Jet	3	Large	Commercial	208 000	169 000	4 922	15 500	1	3JT8D	CNT (lb)	201	101	Fuselage
727D17	Boeing 727-200/JT8D-17	Jet	3	Large	Commercial	208 000	169 000	5 444	16 000	2	3JT8DQ	CNT (lb)	201	101	Fuselage
727EM1	FEDX 727-100/JT8D-7	Jet	3	Large	Commercial	169 500	142 500	4 867	14 000	3	3JT8E7	CNT (lb)	201	101	Fuselage

ACFTID	Description	Engine Type	Numb of Engines	Weight Class	Owner Category	MGTOW (lb)	MCLW (lb)	Max Landing Dist (ft)	Max Sea Level Static Thrust (lb)	Noise Chapter	NPD_ID	Power Parameter	Approach Spectral Class ID	Departure Spectral Class ID	Lateral Directivity Identifier
727EM2	FEDX 727-200/JT8D-15	Jet	3	Large	Commercial	208 000	169 000	4 922	15 500	3	3JT8E5	CNT (lb)	201	101	Fuselage
727Q15	Boeing 727-200/JT8D-15QN	Jet	3	Large	Commercial	208 000	169 000	4 922	15 500	2	3JT8DQ	CNT (lb)	201	101	Fuselage
727Q7	Boeing 727-100/JT8D-7QN	Jet	3	Large	Commercial	169 500	142 500	4 867	14 000	2	3JT8DQ	CNT (lb)	201	101	Fuselage
727Q9	Boeing 727-200/JT8D-9	Jet	3	Large	Commercial	191 000	160 000	5 444	14 500	2	3JT8DQ	CNT (lb)	201	101	Fuselage
727QF	UPS 727-100 22C 25C	Jet	3	Large	Commercial	169 000	142 500	4 448	15 380	3	TAY651	CNT (lb)	201	101	Fuselage
737	Boeing 737/JT8D-9	Jet	2	Large	Commercial	109 000	98 000	3 900	14 500	1	2JT8DW	CNT (lb)	201	101	Wing
737300	Boeing 737-300/CFM56-3B-1	Jet	2	Large	Commercial	135 000	114 000	4 580	20 000	3	CFM563	CNT (lb)	202	102	Wing
7373B2	Boeing 737-300/CFM56-3B-2	Jet	2	Large	Commercial	139 500	114 000	4 580	22 000	3	CFM563	CNT (lb)	202	102	Wing
737400	Boeing 737-400/CFM56-3C-1	Jet	2	Large	Commercial	150 000	124 000	5 062	23 500	3	CFM563	CNT (lb)	202	102	Wing
737500	Boeing 737-500/CFM56-3C-1	Jet	2	Large	Commercial	133 500	111 000	4 551	20 000	3	CFM563	CNT (lb)	202	102	Wing
737700	Boeing 737-700/CFM56-7B24	Jet	2	Large	Commercial	154 500	129 200	4 445	24 000	3	CF567B	CNT (lb)	203	104	Wing
737800	Boeing 737-800/CFM56-7B26	Jet	2	Large	Commercial	174 200	146 300	5 435	26 300	3	CF567B	CNT (lb)	203	104	Wing
737D17	Boeing 737-200/JT8D-17	Jet	2	Large	Commercial	124 000	107 000	4 244	16 000	2	2JT8QW	CNT (lb)	201	101	Wing

ACFTID	Description	Engine Type	Numb of Engines	Weight Class	Owner Category	MGTOW (lb)	MGLW (lb)	Max Landing Dist (ft)	Max Sea Level Static Thrust (lb)	Noise Chapter	NPD_ID	Power Parameter	Approach Spectral Class ID	Departure Spectral Class ID	Lateral Directivity Identifier
737N17	Boeing 737-200/JT8D-17 Nordam B737 LGW Hushkit	Jet	2	Large	Commercial	124 000	107 000	4 244	16 000	3	2JT8DN	CNT (lb)	202	104	Wing
737N9	Boeing 737/JT8D-9 Nordam B737 LGW Hushkit	Jet	2	Large	Commercial	109 000	98 000	3 900	14 500	3	2JT8DN	CNT (lb)	202	104	Wing
737QN	Boeing 737/JT8D-9QN	Jet	2	Large	Commercial	109 000	98 000	3 900	14 500	2	2JT8QW	CNT (lb)	201	101	Wing
747100	Boeing 747-100/JT9D8D	Jet	4	Heavy	Commercial	733 000	516 600	5 727	33 042	2	JT9D8D	CNT (lb)	209	107	Wing
74710Q	Boeing 747-100/JT9D-7QN	Jet	4	Heavy	Commercial	733 000	564 000	6 200	45 500	3	JT9DFL	CNT (lb)	207	107	Wing
747200	Boeing 747-200/JT9D-7	Jet	4	Heavy	Commercial	775 000	564 000	6 200	45 500	3	JT9DFL	CNT (lb)	207	107	Wing
74720A	Boeing 747-200/JT9D-7A	Jet	4	Heavy	Commercial	785 000	564 000	6 200	46 300	3	JT9D7Q	CNT (lb)	207	107	Wing
74720B	Boeing 747-200/JT9D-7Q	Jet	4	Heavy	Commercial	800 000	630 000	6 200	53 000	3	JT9D7Q	CNT (lb)	207	107	Wing
747400	Boeing 747-400/PW4056	Jet	4	Heavy	Commercial	875 000	652 000	6 989	56 800	3	PW4056	CNT (lb)	207	107	Wing
7478	Boeing 747-8F/G/Enx-2B67	Jet	4	Heavy	Commercial	987 000	757 000	7 900	68 000	4	GENX67	CNT (lb)	205	107	Wing
747SP	Boeing 747SP/JT9D-7	Jet	4	Heavy	Commercial	702 000	475 000	5 911	45 500	3	JT9DFL	CNT (lb)	207	107	Wing
757300	Boeing 757-300/RB211-535E-4B	Jet	2	Large	Commercial	275 000	224 000	5 651	43 100	3	RR535E	CNT (lb)	203	103	Wing
757PW	Boeing 757-200/PW2037	Jet	2	Large	Commercial	255 000	210 000	4 790	38 300	3	PW2037	CNT (lb)	203	103	Wing

ACFTID	Description	Engine Type	Numb of Engines	Weight Class	Owner Category	MCTOW (lb)	MCLW (lb)	Max Landing Dist (ft)	Max Sea Level Static Thrust (lb)	Noise Chapter	NPD_ID	Power Parameter	Approach Spectral Class ID	Departure Spectral Class ID	Lateral Directivity Identifier
757RR	Boeing 757-200/RB211-535E4	Jet	2	Large	Commercial	255 000	210 000	4 640	40 100	3	RR535E	CNT (lb)	203	103	Wing
767300	Boeing 767-300/PW4060	Jet	2	Heavy	Commercial	407 000	320 000	4 710	60 000	3	2CF680	CNT (lb)	203	103	Wing
767400	Boeing 767-400ER/CF6-80C2B(f)	Jet	2	Heavy	Commercial	450 000	340 000	6 000	58 685	3	CF680C	CNT (lb)	205	102	Wing
767CF6	Boeing 767-200/CF6-80A	Jet	2	Heavy	Commercial	315 500	270 000	4 700	48 000	3	2CF680	CNT (lb)	203	103	Wing
767JT9	Boeing 767-200/JT9D-7R4D	Jet	2	Heavy	Commercial	351 000	270 000	4 744	48 000	3	2CF680	CNT (lb)	203	103	Wing
777200	Boeing 777-200/GE90-76B	Jet	2	Heavy	Commercial	656 000	470 000	4 450	90 000	3	GE90	CNT (lb)	205	105	Wing
777300	Boeing 777-300/Trent 892	Jet	2	Heavy	Commercial	660 000	524 000	6 012	77 000	0	TRENT8	CNT (lb)	203	105	Wing
7773ER	Boeing 777-300ER/GE90-115B-EIS	Jet	2	Heavy	Commercial	775 000	554 000	5 805	115 000	3	GE9015	CNT (lb)	204	107	Wing
7878R	Boeing 787-8/TI1000-C/01 Family Plan Cert	Jet	2	Heavy	Commercial	502 500	380 000	5 090	70 000	4	TIKBFP	CNT (lb)	205	103	Wing
A300-622R	Airbus A300-622R/PW4158	Jet	2	Heavy	Commercial	378 533	308 647	4 735	58 000	3	PW4158	CNT (lb)	202	103	Wing
A300B4-203	Airbus A300B4-200/CF6-50C2	Jet	2	Heavy	Commercial	364 000	295 000	5 367	52 500	3	2CF650	CNT (lb)	203	103	Wing
A310-304	Airbus A310-304/GE CF6-80C2A2	Jet	2	Heavy	Commercial	346 126	273 373	4 682	53 500	3	A310	CNT (lb)	204	103	Wing
A319-131	Airbus A319-131/V2522-A5	Jet	2	Large	Commercial	166 449	137 789	4 364	22 000	3	V2522A	CNT (lb)	205	103	Wing

ACFTID	Description	Engine Type	Numb of Engines	Weight Class	Owner Category	MGTOW (lb)	MCLW (lb)	Max Landing Dist (ft)	Max Sea Level Static Thrust (lb)	Noise Chapter	NPD_ID	Power Parameter	Approach Spectral Class ID	Departure Spectral Class ID	Lateral Directivity Identifier
A320-211	Airbus A320-211/ CFM56-5A1	Jet	2	Large	Commercial	169 756	142 198	4 753	25 000	3	CFM565	CNT (lb)	202	103	Wing
A320-232	Airbus A320-232/ V2527-A5	Jet	2	Large	Commercial	169 756	145 505	4 917	26 500	3	V2527A	CNT (lb)	205	103	Wing
A321-232	Airbus A321-232/IAE V2530-A5	Jet	2	Large	Commercial	196 211	166 449	5 587	30 000	3	V2530	CNT (lb)	202	103	Wing
A330-301	Airbus A330-301/GE CF6-80 E1A2	Jet	2	Heavy	Commercial	478 400	383 604	5 966	67 500	3	CF680E	CNT (lb)	202	102	Wing
A330-343	Airbus A330-343/RR Trent 772B	Jet	2	Heavy	Commercial	513 677	412 264	5 512	71 100	3	TRENT7	CNT (lb)	205	102	Wing
A340-211	Airbus A340-211/ CFM56-5C2	Jet	4	Heavy	Commercial	573 200	399 036	5 900	31 200	3	CF565C	CNT (lb)	206	107	Wing
A340-642	Airbus A340-642/RR Trent 556	Jet	4	Heavy	Commercial	804 687	564 383	6 919	56 000	4	TRENT5	CNT (lb)	205	102	Wing
A380-841	Airbus A380-841/RR Trent 970	Jet	4	Heavy	Commercial	1 254 430	862 007	6 752	70 000	4	TRENT9	CNT (lb)	205	105	Wing
A380-861	Airbus A380-861/EA GP7270	Jet	4	Heavy	Commercial	1 254 430	862 007	6 837	70 000	4	GP7270	CNT (lb)	206	105	Wing
BAC111	BAC 111/SPEY MK511- 14	Jet	2	Large	Commercial	89 600	82 000	4 449	11 400	2	2J78D	CNT (lb)	201	101	Fuselage
BAE146	BAe 146-200/ALF502R- 5	Jet	4	Large	Commercial	93 000	81 000	3 770	6 970	3	AL502R	CNT (lb)	206	108	Wing
BAE300	BAe 146-300/ALF502R- 5	Jet	4	Large	Commercial	97 500	84 500	3 960	6 970	3	AL502R	CNT (lb)	206	108	Wing
BEC58P	Raytheon BARON 58P/ TS10-520-L	Piston	2	Small	General Aviation	6 100	6 100	2 733	779	0	TSIO52	CNT (% of Max Static Thrust)	215	109	Prop

ACFTID	Description	Engine Type	Numb of Engines	Weight Class	Owner Category	MGTOW (lb)	MCLW (lb)	Max Landing Dist (ft)	Max Sea Level Static Thrust (lb)	Noise Chapter	NPD_ID	Power Parameter	Approach Spectral Class ID	Departure Spectral Class ID	Lateral Directivity Identifier
CIT3	Cessna Citation III/ TFE731-3-100S	Jet	2	Large	General Aviation	20 000	17 000	2 770	3 650	3	TF7313	CNT (lb)	216	113	Fuselage
CL600	Canadair CL-600/ ALF502L	Jet	2	Large	General Aviation	36 000	33 000	3 300	7 500	3	AL502L	CNT (lb)	216	113	Fuselage
CL601	Canadair CL-601/CF34-3A	Jet	2	Large	General Aviation	43 100	36 000	3 550	9 220	3	CF34	CNT (lb)	216	113	Fuselage
CNA172	Cessna 172R/Lycoming IO-360-12A	Piston	1	Small	General Aviation	2 450	2 450	1 695	436	0	IO360L	CNT (% of Max Static Thrust)	215	109	Prop
CNA182	Cessna 182H/Continental O-470-R	Piston	1	Small	General Aviation	2 800	2 800	1 544	965	2	O470R	CNT (lb)	215	113	Prop
CNA206	Cessna 206H/Lycoming IO-540-AC	Piston	1	Small	General Aviation	3 600	3 600	1 880	798	0	IO540	Other (RPM)	215	109	Prop
CNA208	Cessna 208/PT6A-114	Turbo-prop	1	Small	General Aviation	8 750	8 500	1 740	2 300	3	PT6-A114	CNT (lb)	210	109	Prop
CNA20T	Cessna T206H/Lycoming TIO-540-AJ1A	Piston	1	Small	General Aviation	3 600	3 600	1 880	825	0	TIO540	Other (RPM)	215	109	Prop
CNA441	Cessna CONQUEST II /TPE331-8	Turbo-prop	2	Small	Commercial	9 900	9 400	1 939	1 535	0	TPE331	CNT (% of Max Static Thrust)	210	111	Prop
CNA500	Cessna Citation II/JT15D-4	Jet	2	Large	General Aviation	14 700	14 000	3 050	2 500	3	JT15D1	CNT (lb)	216	113	Fuselage
CNA510	Cessna Mustang Model 510/PW615F	Jet	2	Small	Commercial	8 645	7 200	3 010	1 466	0	PW615F	CNT (lb)	203	113	Fuselage
CNA525C	Cessna Citation CJ4 525C /FJ44-4A	Jet	2	Small	Commercial	16 950	15 500	3 010	3 600	4	FJ44-4	CNT (lb)	235	136	Fuselage

ACFTID	Description	Engine Type	Numb of Engines	Weight Class	Owner Category	MGTOW (lb)	MGIW (lb)	Max Landing Dist (ft)	Max Sea Level Static Thrust (lb)	Noise Chapter	NPD_ID	Power Parameter	Approach Spectral Class ID	Departure Spectral Class ID	Lateral Directivity Identifier
CNA55B	Cessna 550 Citation Bravo/PW530A	Jet	2	Large	General Aviation	14 800	13 500	3 010	2 863	0	PW530A	CNT (lb)	203	113	Fuselage
CNA560E	Cessna Citation Encore 560/PW535A	Jet	2	Small	Commercial	16 300	13 680	3 000	3 313	3	2PW535	CNT (lb)	238	138	Fuselage
CNA560U	Cessna Citation Ultra 560/JT15D-5D	Jet	2	Small	Commercial	16 300	13 680	2 700	3 029	3	2J155D	CNT (lb)	237	113	Fuselage
CNA560XL	Cessna Citation Excel 560/PW545A	Jet	2	Small	Commercial	20 000	16 830	3 000	3 824	3	PW545A	CNT (lb)	238	137	Fuselage
CNA680	Cessna Citation Sovereign 680/PW306C	Jet	2	Small	Commercial	30 000	24 390	3 010	5 749	3	PW306C	CNT (lb)	236	136	Fuselage
CNA750	Cessna Citation X/Rolls Royce Allison AE3007C	Jet	2	Large	General Aviation	35 700	31 800	3 500	6 407	3	AE300C	CNT (lb)	202	105	Fuselage
CONCRD	Concorde(OLY593	Jet	4	Heavy	Commercial	400 000	245 000	10 600	38 100	0	OLY593	CNT (lb)	206	106	Wing
CRJ9-ER	Bombardier CRJ-600-2D15/CL-600-2D24/CF34-8C5	Jet	2	Large	Commercial	82 500	73 500	5 779	13 525	3	CF34-8C5	CNT (lb)	216	113	Fuselage
CRJ9-LR	Bombardier CRJ-600-2D15/CL-600-2D24/CF34-8C5	Jet	2	Large	Commercial	84 500	75 100	5 680	13 525	3	CF34-8C5	CNT (lb)	216	113	Fuselage
CVR580	Convair CV-580/ALL 501-D15	Turbo-prop	2	Large	Commercial	58 000	52 000	4 256	8 100	0	501D13	CNT (% of Max Static Thrust)	214	112	Prop
DC1010	McDonnell Douglas DC10-10/CF6-6D	Jet	3	Heavy	Commercial	455 000	363 000	5 820	40 000	3	CF66D	CNT (lb)	203	101	Wing
DC1030	McDonnell Douglas DC10-30/CF6-50C2	Jet	3	Heavy	Commercial	572 000	403 000	5 418	53 200	3	CF66D	CNT (lb)	203	101	Wing

ACFTID	Description	Engine Type	Numb of Engines	Weight Class	Owner Category	MGTOW (lb)	MGLW (lb)	Max Landing Dist (ft)	Max Sea Level Static Thrust (lb)	Noise Chapter	NPD_ID	Power Parameter	Approach Spectral Class ID	Departure Spectral Class ID	Lateral Directivity Identifier
DC1040	McDonnell Douglas DC10-40/JT9D-20	Jet	3	Heavy	Commercial	555 000	403 000	6 020	49 400	3	CF66D	CNT (lb)	203	101	Wing
DC3	Douglas DC-3/R1820-86	Piston	2	Large	Commercial	28 000	24 500	2 222	3 120	0	2R2800	CNT (% of Max Static Thrust)	213	110	Prop
DC6	Douglas DC-6/R2800-CB17	Piston	4	Large	Commercial	106 000	95 000	3 010	4 180	0	4R2800	CNT (% of Max Static Thrust)	213	110	Prop
DC820	Douglas DC-8-20/JT4A	Jet	4	Heavy	Commercial	317 600	194 400	6 527	11 850	1	JT4A	CNT (lb)	208	107	Wing
DC850	Douglas DC-8-50/JT3D-3B	Jet	4	Heavy	Commercial	325 000	240 000	5 400	18 000	1	JT3D	CNT (lb)	208	107	Wing
DC860	Douglas DC-8-60/JT3D-7	Jet	4	Heavy	Commercial	355 000	275 000	5 310	19 000	1	JT3D	CNT (lb)	208	107	Wing
DC870	Douglas DC-8-70/CFM56-2C-5	Jet	4	Heavy	Commercial	355 000	258 000	6 500	22 000	3	CFM562	CNT (lb)	206	106	Wing
DC8QN	Douglas DC-8-60/JT8D-7QN	Jet	4	Heavy	Commercial	355 000	275 000	5 310	19 000	2	JT3DQ	CNT (lb)	208	106	Wing
DC910	McDonnell Douglas DC-9-10/JT8D-7	Jet	2	Large	Commercial	90 700	81 700	5 030	14 000	1	2JT8D	CNT (lb)	201	101	Fuselage
DC930	McDonnell Douglas DC-9-30/JT8D-9	Jet	2	Large	Commercial	114 000	102 000	4 680	14 500	1	2JT8D	CNT (lb)	201	101	Fuselage
DC931W	McDonnell Douglas DC-9-30/JT8D-9 w/ABS Lightweight hushkit	Jet	2	Large	Commercial	114 000	102 000	4 680	14 500	3	2JT8DL	CNT (lb)	201	101	Fuselage
DC950	McDonnell Douglas DC-9-50/JT8D-17	Jet	2	Large	Commercial	121 000	110 000	4 880	16 000	2	2JT8DQ	CNT (lb)	201	101	Fuselage

ACFTID	Description	Engine Type	Numb of Engines	Weight Class	Owner Category	MGTOW (lb)	MGIW (lb)	Max Landing Dist (ft)	Max Sea Level Static Thrust (lb)	Noise Chapter	NPD_ID	Power Parameter	Approach Spectral Class ID	Departure Spectral Class ID	Lateral Directivity Identifier
DC95HW	McDonnell Douglas DC-9-50/T8D17 w/ ABS Heavyweight hushkit	Jet	2	Large	Commercial	121 000	110 000	4 880	16 000	3	2JT8DH	CNT (lb)	201	101	Fuselage
DC9Q7	McDonnell Douglas DC-9-10/T8D-7QN	Jet	2	Large	Commercial	90 700	81 700	5 030	14 000	2	2JT8DQ	CNT (lb)	201	101	Fuselage
DC9Q9	McDonnell Douglas DC-9-30/T8D-9QN	Jet	2	Large	Commercial	114 000	102 000	4 680	14 500	2	2JT8DQ	CNT (lb)	201	101	Fuselage
DHC6	De Havilland DASH 6/PT6A-27	Turbo-prop	2	Small	Commercial	12 500	12 300	1 500	2 000	0	PT6A27	CNT (% of Max Static Thrust)	210	109	Prop
DHC6QP	De Havilland DASH 6/PT6A-27 Raisbeck Quiet PropMod	Turbo-prop	2	Small	Commercial	12 500	12 300	1 500	2 000	0	RAISQP	CNT (% of Max Static Thrust)	210	109	Prop
DHC7	De Havilland DASH 7/PT6A-50	Turbo-prop	4	Large	Commercial	41 000	39 000	2 150	2 850	3	PT6A50	CNT (% of Max Static Thrust)	213	112	Prop
DHC8	Bombardier de Havilland DASH 8-100/PW121	Turbo-prop	2	Large	Commercial	34 500	33 900	3 000	4 750	3	PW120	CNT (% of Max Static Thrust)	213	112	Prop
DHC830	Bombardier de Havilland DASH 8-300/PW123	Turbo-prop	2	Large	Commercial	43 000	42 000	3 500	4 918	3	PW120	CNT (% of Max Static Thrust)	213	112	Prop
DO228	Dornier 228-202/TPE 311-5	Turbo-prop	2	Large	Commercial	13 669	13 448	2 375	2 240	3	TPE331-5	CNT (lb)	216	110	Prop
DO328	Dornier 328-100/PW119C	Turbo-prop	2	Large	Commercial	30 843	29 167	3 825	6 745	3	PW119C	CNT (lb)	214	109	Prop

ACFTID	Description	Engine Type	Numb of Engines	Weight Class	Owner Category	MGTOW (lb)	MGLW (lb)	Max Landing Dist (ft)	Max Sea Level Static Thrust (lb)	Noise Chapter	NPD_ID	Power Parameter	Approach Spectral Class ID	Departure Spectral Class ID	Lateral Directivity Identifier
ECLIPS-E500	Eclipse 500/PW610F	Jet	2	Small	General Aviation	6 000	5 600	2 389	1 031	3	PW610F	CNT (lb)	201	103	Fuselage
EMB120	Embraer 120 ER/Pratt & Whitney PW118	Turbo-prop	2	Large	Commercial	26 433	25 794	5 571	4 000	3	EPW118	CNT (lb)	213	109	Prop
EMB145	Embraer 145 ER/Allison AE3007	Jet	2	Large	Commercial	45 420	41 230	4 232	7 500	3	AE3007	CNT (lb)	216	113	Fuselage
EMB14L	Embraer 145 LR/Allison AE3007A1	Jet	2	Large	Commercial	48 500	42 550	4 232	7 500	3	AE3007	CNT (lb)	216	113	Fuselage
EMB170	Embraer ERJ170-100	Jet	2	Large	Commercial	82 012	72 312	4 029	13 800	3	CF348E	CNT (lb)	216	113	Wing
EMB175	Embraer ERJ170-200	Jet	2	Large	Commercial	85 517	74 957	4 130	13 800	3	CF348E	CNT (lb)	216	113	Wing
EMB190	Embraer ERJ190-100	Jet	2	Large	Commercial	114 199	97 003	4 081	18 500	3	CF3410E	CNT (lb)	205	105	Wing
EMB195	Embraer ERJ190-200	Jet	2	Large	Commercial	115 280	100 972	4 183	18 500	3	CF3410E	CNT (lb)	205	105	Wing
F10062	Fokker 100/TAY 620-15	Jet	2	Large	Commercial	95 000	85 500	4 560	13 900	3	TAY620	CNT (lb)	201	101	Fuselage
F10065	Fokker 100/TAY 650-15	Jet	2	Large	Commercial	98 000	88 000	4 704	15 100	3	TAY650	CNT (lb)	201	101	Fuselage
F28MK2	Fokker F-28-2000/ RB183MK555	Jet	2	Large	Commercial	65 000	59 000	3 540	9 850	2	RB183	CNT (lb)	216	104	Fuselage
F28MK4	Fokker F-28-4000/ RB183MK555	Jet	2	Large	Commercial	73 000	64 000	3 546	9 900	2	RB183P	CNT (lb)	216	104	Fuselage
FAL20	Dassault FALCON 20/ CF700-2D-2	Jet	2	Large	General Aviation	28 700	27 300	2 490	4 500	2	CF700	CNT (lb)	203	113	Fuselage

ACFTID	Description	Engine Type	Numb of Engines	Weight Class	Owner Category	MGTOW (lb)	MCLW (lb)	Max Landing Dist (ft)	Max Sea Level Static Thrust (lb)	Noise Chapter	NPD_ID	Power Parameter	Approach Spectral Class ID	Departure Spectral Class ID	Lateral Directivity Identifier
GII	Gulfstream GII/SPEY 511-8	Jet	2	Large	General Aviation	64 800	58 500	3 200	11 400	2	SPEYHK	CNT (lb)	216	104	Fuselage
GIIIB	Gulfstream GIIIB/GIII — SPEY 511-8	Jet	2	Large	General Aviation	69 700	58 500	3 250	11 400	2	SPEYHK	CNT (lb)	216	104	Fuselage
GIV	Gulfstream GIV-SP/TAY 611-8	Jet	2	Large	General Aviation	74 600	66 000	3 190	13 850	3	TAYGIV	CNT (lb)	203	113	Fuselage
GV	Gulfstream GV/BR 710	Jet	2	Large	General Aviation	90 500	75 300	2 760	14 750	3	BR710	CNT (lb)	205	105	Fuselage
HS748A	Hawker Siddeley HS-748/DART MK532-2	Turbo-prop	2	Large	Commercial	46 500	43 000	3 360	5 150	2	RDA532	CNT (% of Max Static Thrust)	212	110	Prop
IA1125	IAI-1125 AS/TRA/TFE731-3A	Jet	2	Large	General Aviation	23 500	20 700	3 689	3 700	3	TF7313	CNT (lb)	216	113	Fuselage
L1011	Lockheed Martin L-1011/RB211-22B	Jet	3	Heavy	Commercial	430 000	358 000	5 693	42 000	3	RB2112	CNT (lb)	203	101	Wing
L10115	Lockheed Martin L-1011-500/RB211-224B	Jet	3	Heavy	Commercial	510 000	368 000	6 800	50 000	3	RB2112	CNT (lb)	203	101	Wing
L188	Lockheed L-188C/ALL 501-D13	Turbo-prop	4	Large	Commercial	116 000	98 100	4 960	8 000	0	T56A7	CNT (% of Max Static Thrust)	214	112	Prop
LEAR25	Learjet 25/CJ610-8	Jet	2	Large	General Aviation	15 000	13 500	2 620	2 950	2	CJ610	CNT (lb)	202	113	Fuselage
LEAR35	Learjet 36/TFE731-2	Jet	2	Large	General Aviation	18 300	15 300	3 076	3 500	3	TF7312	CNT (lb)	216	113	Fuselage
MD11GE	McDonnell Douglas MD-11/CF6-80C2D1F	Jet	3	Heavy	Commercial	682 400	433 300	5 131	61 500	3	2CF68D	CNT (lb)	203	103	Wing
MD11PW	McDonnell Douglas MD-11/PW 4460	Jet	3	Heavy	Commercial	682 400	433 300	4 681	60 000	3	PW4460	CNT (lb)	203	103	Wing

ACFTID	Description	Engine Type	Numb of Engines	Weight Class	Owner Category	MGTOW (lb)	MCLW (lb)	Max Landing Dist (ft)	Max Sea Level Static Thrust (lb)	Noise Chapter	NPD_ID	Power Parameter	Approach Spectral Class ID	Departure Spectral Class ID	Lateral Directivity Identifier
MD81	McDonnell Douglas MD-81/JT8D-209	Jet	2	Large	Commercial	140 000	128 000	4 860	19 300	3	2JT8D2	CNT (lb)	204	104	Fuselage
MD82	McDonnell Douglas MD-82/JT8D-217A	Jet	2	Large	Commercial	149 500	130 000	4 920	20 900	3	2JT8D2	CNT (lb)	204	104	Fuselage
MD83	McDonnell Douglas MD-83/JT8D-219	Jet	2	Large	Commercial	160 000	139 500	5 200	21 700	3	2JT8D2	CNT (lb)	204	104	Fuselage
MD9025	McDonnell Douglas MD-90/V2525-D5	Jet	2	Large	Commercial	156 000	142 000	3 000	25 000	3	V2525	CNT (lb)	205	105	Fuselage
MD9028	McDonnell Douglas MD-90/V2528-D5	Jet	2	Large	Commercial	156 000	142 000	3 000	28 000	3	V2525	CNT (lb)	205	105	Fuselage
MU3001	Mitsubishi MU300-10 Diamond II/JT15D-5	Jet	2	Large	General Aviation	14 100	13 200	2 800	2 500	3	JT15D5	CNT (lb)	203	113	Fuselage
PA28	Piper Warrior PA-28-161/O-320-D3G	Piston	1	Small	General Aviation	2 325	2 325	1 695	400	0	O320D3	Other (RPM)	213	113	Prop
PA30	Piper Twin Comanche PA-30/IO-320-B1A	Piston	2	Small	General Aviation	3 600	3 600	1 654	777	0	IO320B	CNT (lb)	213	113	Prop
PA31	Piper Navajo Chieftrain PA-31-350/TIO-5	Piston	2	Small	General Aviation	7 000	7 000	1 850	1 481	0	TIO542	Other (RPM)	213	109	Prop
PA42	Piper PA-42/PT6A-41	Turbo-prop	2	Small	General Aviation	11 200	10 330	3 300	1 800	3	PT6A41	CNT (lb)	213	109	Prop
SABR80	NA Sabreliner 80	Jet	2	Large	General Aviation	33 720	27 290	2 490	3 962	2	CF700	CNT (lb)	203	113	Fuselage
SD330	Short SD3-30/PT6A-45AR	Turbo-prop	2	Large	Commercial	22 900	22 600	3 650	2 670	3	PT6A45	CNT (% of Max Static Thrust)	211	109	Prop
SF340	Saab SF340B/CT7-9B	Turbo-prop	2	Large	Commercial	27 300	26 500	3 470	4 067	3	CT75	CNT (% of Max Static Thrust)	211	110	Prop

Table I-6
Default weights

ACFTID	Stage Length	Weight (lb)
1900D	1	15 500
1900D	2	16 950
707	1	175 000
707	2	185 000
707	3	200 000
707	4	220 000
707	5	245 000
707	6	257 000
707120	1	175 000
707120	2	185 000
707120	3	200 000
707120	4	220 000
707120	5	245 000
707120	6	257 000
707320	1	214 000
707320	2	228 000
707320	3	240 000
707320	4	260 000
707320	5	286 000
707320	6	312 000
707320	7	330 000
707QN	1	214 000
707QN	2	228 000
707QN	3	240 000
707QN	4	260 000
707QN	5	286 000
707QN	6	312 000
707QN	7	330 000
717200	1	94 900
717200	2	99 700
717200	3	104 900
717200	4	110 400

ACFTID	Stage Length	Weight (lb)
717200	5	112 700
717200	6	121 000
720	1	145 000
720	2	155 000
720	3	165 000
720	4	180 000
720	5	190 000
720B	1	165 000
720B	2	175 000
720B	3	185 000
720B	4	200 000
720B	5	210 000
727100	1	136 000
727100	2	143 000
727100	3	150 000
727100	4	158 000
727200	1	152 000
727200	2	163 000
727200	3	174 000
727200	4	185 000
727D15	1	156 000
727D15	2	164 000
727D15	3	175 000
727D15	4	189 000
727D15	5	204 000
727D17	1	157 000
727D17	2	169 000
727D17	3	180 000
727D17	4	189 000
727EM1	1	136 000
727EM1	2	143 000
727EM1	3	150 000

ACFTID	Stage Length	Weight (lb)
727EM1	4	158 000
727EM2	1	156 000
727EM2	2	164 000
727EM2	3	175 000
727EM2	4	189 000
727EM2	5	204 000
727Q15	1	156 000
727Q15	2	164 000
727Q15	3	175 000
727Q15	4	189 000
727Q15	5	204 000
727Q7	1	136 000
727Q7	2	143 000
727Q7	3	150 000
727Q7	4	158 000
727Q9	1	156 000
727Q9	2	168 000
727Q9	3	180 000
727Q9	4	191 000
727QF	1	136 000
727QF	2	143 000
727QF	3	150 000
727QF	4	158 000
737	1	82 000
737	2	85 000
737	3	92 000
737	4	100 000
737300	1	108 800
737300	2	114 100
737300	3	119 900
737300	4	131 800
7373B2	1	108 800

ACFTID	Stage Length	Weight (lb)
7373B2	2	114 100
7373B2	3	119 900
7373B2	4	131 800
7373B2	M	139 500
737400	1	115 800
737400	2	121 400
737400	3	127 700
737400	4	138 200
737400	M	150 000
737500	1	103 400
737500	2	108 500
737500	3	114 100
737500	4	125 700
737500	5	126 900
737500	M	128 500
737700	1	120 000
737700	2	125 000
737700	3	130 300
737700	4	141 100
737700	5	154 400
737700	6	154 500
737800	1	133 300
737800	2	139 200
737800	3	145 500
737800	4	156 700
737800	5	167 600
737800	6	172 300
737D17	1	90 000
737D17	2	95 000
737D17	3	100 000
737D17	4	105 000
737N17	1	90 000

ACFTID	Stage Length	Weight (lb)
737N17	2	95 000
737N17	3	100 000
737N17	4	105 000
737N9	1	82 000
737N9	2	85 000
737N9	3	92 000
737N9	4	100 000
737QN	1	82 000
737QN	2	85 000
737QN	3	92 000
737QN	4	100 000
747100	1	475 000
747100	2	495 000
747100	3	520 000
747100	4	550 000
747100	5	625 000
747100	6	635 000
74710Q	1	475 000
74710Q	2	495 000
74710Q	3	520 000
74710Q	4	550 000
74710Q	5	625 000
74710Q	6	635 000
747200	1	525 000
747200	2	545 000
747200	3	565 000
747200	4	610 000
747200	5	665 000
747200	6	725 000
747200	7	775 000
74720A	1	475 000
74720A	2	500 000

ACFTID	Stage Length	Weight (lb)
74720A	3	520 000
74720A	4	560 000
74720A	5	610 000
74720A	6	675 000
74720A	7	725 000
74720B	1	525 000
74720B	2	545 000
74720B	3	565 000
74720B	4	610 000
74720B	5	665 000
74720B	6	725 000
74720B	7	775 000
747400	1	545 000
747400	2	563 800
747400	3	583 100
747400	4	621 500
747400	5	669 500
747400	6	720 900
747400	7	776 600
747400	8	836 200
747400	9	875 000
7478	1	671 100
7478	2	691 200
7478	3	713 300
7478	4	752 400
7478	5	801 000
7478	6	853 400
7478	7	909 300
7478	8	969 000
7478	9	987 000
747SP	1	400 000
747SP	2	422 000

ACFTID	Stage Length	Weight (lb)
747SP	3	443 000
747SP	4	475 000
747SP	5	518 000
747SP	6	560 000
747SP	7	625 000
757300	1	203 900
757300	2	212 700
757300	3	222 100
757300	4	239 100
757300	5	260 700
757300	6	269 400
757PW	1	183 200
757PW	2	190 000
757PW	3	197 500
757PW	4	212 600
757PW	5	230 900
757PW	6	243 200
757PW	7	255 000
757RR	1	183 900
757RR	2	191 200
757RR	3	199 100
757RR	4	215 200
757RR	5	234 800
757RR	6	243 200
757RR	7	255 000
767300	1	265 000
767300	2	275 500
767300	3	286 400
767300	4	305 700
767300	5	330 000
767300	6	355 900
767300	7	367 700

ACFTID	Stage Length	Weight (lb)
767400	1	288 818
767400	2	299 037
767400	3	310 125
767400	4	329 861
767400	5	354 427
767400	6	380 906
767400	7	422 420
767CF6	1	227 000
767CF6	2	236 000
767CF6	3	245 300
767CF6	4	261 400
767CF6	5	281 600
767CF6	6	303 300
767CF6	7	315 500
767JT9	1	228 500
767JT9	2	237 600
767JT9	3	247 000
767JT9	4	263 600
767JT9	5	284 600
767JT9	6	306 900
767JT9	7	317 100
777200	1	429 900
777200	2	442 400
777200	3	456 100
777200	4	483 100
777200	5	516 400
777200	6	551 700
777200	7	589 400
777200	8	629 500
777200	9	656 000
777300	1	435 100
777300	2	449 700

ACFTID	Stage Length	Weight (lb)
777300	3	465 300
777300	4	493 100
777300	5	527 700
777300	6	564 500
777300	7	636 100
7773ER	1	503 600
7773ER	2	519 100
7773ER	3	536 100
7773ER	4	565 800
7773ER	5	602 700
7773ER	6	642 600
7773ER	7	684 500
7773ER	8	728 900
7773ER	9	775 000
7878R	1	343 400
7878R	2	353 200
7878R	3	363 900
7878R	4	382 600
7878R	5	405 700
7878R	6	430 100
7878R	7	455 900
7878R	8	483 600
7878R	9	502 500
A300-622R	1	278 700
A300-622R	2	290 300
A300-622R	3	302 400
A300-622R	4	324 100
A300-622R	5	353 300
A300-622R	6	378 500
A300B4-203	1	262 000
A300B4-203	2	280 000
A300B4-203	3	295 000

ACFTID	Stage Length	Weight (lb)
A300B4-203	4	324 000
A300B4-203	5	357 000
A310-304	1	243 300
A310-304	2	253 000
A310-304	3	262 900
A310-304	4	280 700
A310-304	5	304 400
A310-304	6	346 100
A319-131	1	125 900
A319-131	2	131 000
A319-131	3	136 500
A319-131	4	146 100
A319-131	5	166 400
A320-211	1	133 400
A320-211	2	139 200
A320-211	3	145 200
A320-211	4	155 900
A320-211	5	169 800
A320-232	1	132 900
A320-232	2	138 500
A320-232	3	144 200
A320-232	4	154 300
A320-232	5	172 000
A321-232	1	156 800
A321-232	2	163 300
A321-232	3	170 000
A321-232	4	182 100
A321-232	5	206 100
A330-301	1	367 000
A330-301	2	378 500
A330-301	3	390 500
A330-301	4	411 700

ACFTID	Stage Length	Weight (lb)
A330-301	5	439 200
A330-301	6	469 100
A330-301	7	478 400
A330-343	1	369 200
A330-343	2	380 800
A330-343	3	392 900
A330-343	4	414 300
A330-343	5	441 900
A330-343	6	472 000
A330-343	7	513 700
A340-211	1	369 500
A340-211	2	381 600
A340-211	3	394 100
A340-211	4	416 600
A340-211	5	446 000
A340-211	6	477 600
A340-211	7	573 200
A340-642	1	524 100
A340-642	2	540 700
A340-642	3	557 800
A340-642	4	588 000
A340-642	5	628 600
A340-642	6	671 300
A340-642	7	811 300
A380-841	1	799 160
A380-841	2	822 921
A380-841	3	847 265
A380-841	4	890 164
A380-841	5	945 893
A380-841	6	1 006 106
A380-841	7	1 066 266
A380-841	8	1 254 430

ACFTID	Stage Length	Weight (lb)
A380-861	1	798 928
A380-861	2	822 613
A380-861	3	846 941
A380-861	4	889 750
A380-861	5	943 737
A380-861	6	1 003 582
A380-861	7	1 066 266
A380-861	8	1 254 430
BAC111	1	74 000
BAC111	2	79 000
BAC111	3	85 000
BAE146	1	76 000
BAE146	2	84 000
BAE146	3	91 000
BAE300	1	80 000
BAE300	2	88 000
BAE300	3	96 000
BEC58P	1	5 500
CIT3	1	20 000
CL600	1	36 000
CL601	1	43 100
CNA172	1	2 450
CNA182	1	2 800
CNA206	1	3 000
CNA206	2	3 300
CNA206	3	3 600
CNA208	1	8 750
CNA20T	1	3 000
CNA20T	2	3 300
CNA20T	3	3 600
CNA441	1	9 850
CNA500	1	14 700

ACFTID	Stage Length	Weight (lb)
CNA510	1	8 645
CNA525C	1	16 950
CNA55B	1	14 800
CNA560E	1	16 300
CNA560U	1	16 300
CNA560XL	1	20 000
CNA680	1	30 000
CNA750	1	35 700
CONCRD	1	340 000
CONCRD	2	340 000
CONCRD	3	375 000
CONCRD	4	375 000
CONCRD	5	400 000
CONCRD	6	400 000
CRJ9-ER	1	67 500
CRJ9-ER	2	71 000
CRJ9-ER	3	75 000
CRJ9-ER	4	80 000
CRJ9-ER	5	82 500
CRJ9-LR	1	65 500
CRJ9-LR	2	69 000
CRJ9-LR	3	73 000
CRJ9-LR	4	78 000
CRJ9-LR	5	84 500
CVR580	1	49 000
CVR580	2	54 000
CVR580	3	58 000
DC1010	1	325 000
DC1010	2	340 000
DC1010	3	360 000
DC1010	4	390 000
DC1010	5	420 000

ACFTID	Stage Length	Weight (lb)
DC1010	6	450 000
DC1030	1	375 000
DC1030	2	390 000
DC1030	3	405 000
DC1030	4	436 000
DC1030	5	476 000
DC1030	6	517 000
DC1030	7	561 000
DC1040	1	364 000
DC1040	2	379 000
DC1040	3	393 000
DC1040	4	423 000
DC1040	5	462 000
DC1040	6	502 000
DC1040	7	544 000
DC3	1	24 000
DC3	2	26 000
DC3	3	28 000
DC6	1	85 000
DC6	2	95 000
DC6	3	105 000
DC820	1	180 000
DC820	2	190 000
DC820	3	205 000
DC820	4	225 000
DC820	5	250 000
DC820	6	270 000
DC850	1	185 000
DC850	2	195 000
DC850	3	210 000
DC850	4	230 000
DC850	5	255 000

ACFTID	Stage Length	Weight (lb)
DC850	6	275 000
DC860	1	220 000
DC860	2	230 000
DC860	3	245 000
DC860	4	265 000
DC860	5	290 000
DC860	6	305 000
DC860	7	325 000
DC870	1	220 000
DC870	2	230 000
DC870	3	245 000
DC870	4	265 000
DC870	5	290 000
DC870	6	305 000
DC870	7	325 000
DC8QN	1	220 000
DC8QN	2	230 000
DC8QN	3	245 000
DC8QN	4	265 000
DC8QN	5	290 000
DC8QN	6	305 000
DC8QN	7	325 000
DC910	1	70 000
DC910	2	78 000
DC910	3	85 000
DC930	1	93 500
DC930	2	103 000
DC930	3	112 000
DC93LW	1	93 500
DC93LW	2	103 000
DC93LW	3	112 000
DC950	1	100 000

ACFTID	Stage Length	Weight (lb)
DC950	2	107 000
DC950	3	115 000
DC95HW	1	100 000
DC95HW	2	107 000
DC95HW	3	115 000
DC9Q7	1	70 000
DC9Q7	2	78 000
DC9Q7	3	85 000
DC9Q9	1	93 500
DC9Q9	2	103 000
DC9Q9	3	112 000
DHC6	1	12 500
DHC6QP	1	12 500
DHC7	1	38 950
DHC8	1	31 000
DHC830	1	38 700
DO228	1	13 669
DO328	1	30 843
ECLIPSE500	1	5 500
ECLIPSE500	2	5 891
ECLIPSE500	3	6 000
EMB120	1	22 475
EMB145	1	35 500
EMB145	2	39 500
EMB145	3	41 800
EMB145	4	44 000
EMB14L	1	35 275
EMB14L	2	39 675
EMB14L	3	41 900
EMB14L	4	44 100
EMB14L	5	46 300
EMB14L	6	48 500

ACFTID	Stage Length	Weight (lb)
EMB170	1	63 070
EMB170	2	66 599
EMB170	3	70 484
EMB175	1	65 698
EMB175	2	69 459
EMB175	3	73 518
EMB190	1	83 520
EMB190	2	87 757
EMB190	3	92 363
EMB190	4	100 656
EMB195	1	87 096
EMB195	2	91 558
EMB195	3	96 388
EMB195	4	105 138
F10062	1	78 000
F10062	2	86 000
F10062	3	93 000
F10065	1	80 000
F10065	2	88 000
F10065	3	96 000
F28MK2	1	58 000
F28MK2	2	64 000
F28MK4	1	61 000
F28MK4	2	66 000
F28MK4	3	73 000
FAL20	1	28 660
GII	1	56 000
GIB	1	59 245
GIV	1	63 410
GV	1	76 925
HS748A	1	46 500
IA1125	1	23 500

ACFTID	Stage Length	Weight (lb)
L1011	1	330 000
L1011	2	340 000
L1011	3	355 000
L1011	4	370 000
L1011	5	400 000
L1011	6	430 000
L10115	1	345 000
L10115	2	355 000
L10115	3	370 000
L10115	4	385 000
L10115	5	413 000
L10115	6	441 000
L10115	7	470 000
L188	1	93 000
L188	2	102 000
L188	3	115 000
LEAR25	1	15 000
LEAR35	1	18 300
MD11GE	1	395 000
MD11GE	2	410 000
MD11GE	3	425 000
MD11GE	4	460 000
MD11GE	5	495 000
MD11GE	6	535 000
MD11GE	7	580 000
MD11PW	1	395 000
MD11PW	2	410 000
MD11PW	3	425 000
MD11PW	4	460 000
MD11PW	5	495 000
MD11PW	6	535 000
MD11PW	7	580 000

ACFTID	Stage Length	Weight (lb)
MD81	1	120 680
MD81	2	127 804
MD81	3	135 134
MD81	4	140 000
MD82	1	120 383
MD82	2	127 379
MD82	3	134 584
MD82	4	145 838
MD82	5	149 500
MD83	1	121 555
MD83	2	128 361
MD83	3	135 456
MD83	4	147 079
MD83	5	160 000
MD9025	1	131 021
MD9025	2	137 490
MD9025	3	144 181
MD9025	4	151 107
MD9025	5	156 000
MD9028	1	131 021
MD9028	2	137 490
MD9028	3	144 181
MD9028	4	151 107
MD9028	5	156 000
MU3001	1	14 100
PA28	1	2 325
PA30	1	3 600
PA31	1	7 000
PA42	1	11 200
SABR80	1	28 660
SD330	1	21 800
SF340	1	24 548
SF340	2	27 275

Table I-7

Jet engine coefficients

ACFTID	Thrust rating	E (lb)	F (lb/kt)	Ga (lb/ft)	Gb (lb/ft ²)	H (lb/ °C)	K1 (lb/EPR)	K2 (lb/EPR ²)	K3 (lb/(N1/√θ))	K4 (lb/(N1/√θ) ²)
1900D	MaxClimb	2 548,8	- 6,7075	- 0,014	0	- 0,72				
1900D	MaxTakeoff	3 374,6	- 9,6869	- 0,0046	0	- 0,504				
707320	General	- 25 447,4	- 6,79039	- 0,01775	0	0	33 299,8	- 5 817		
707320	MaxClimb	15 943,8	- 13,9584	0,1672	5,7074E-06	0				
707320	MaxTakeoff	18 044,7	- 15,7976	0,1893	6,4595E-06	0				
707QN	General	- 25 447,4	- 6,79039	- 0,01775	0	0	33 299,8	- 5 817		
707QN	MaxClimb	15 943,8	- 13,9584	0,1672	5,7074E-06	0				
707QN	MaxTakeoff	18 044,7	- 15,7976	0,1893	6,4595E-06	0				
717200	MaxClimb	15 541,5	- 17,8282	0,253495	0	0				
717200	MaxClimbHi-Temp	22 232	- 18,025	- 0,201	0	- 218				
717200	MaxTakeoff	17 542,7	- 19,588	0,234981	0	0				
717200	MaxTkoffHi-Temp	22 280,7	- 19,819	- 0,097	0	- 154,5				
720B	General	- 27 419,9	- 5,81791	- 0,01175	0	0	35 654,5	- 6 560,9		
720B	MaxClimb	14 540,1	- 13,4149	0,121548	1,78264E-06	0				
720B	MaxTakeoff	16 768,6	- 15,471	0,140178	2,0559E-06	0				
727100	General	- 14 205,5	- 4,53212	0	0	0	16 602,8	- 1 403,02		
727100	MaxClimb	12 029,2	- 7,99864	- 0,05203	5,44617E-06	0				
727100	MaxTakeoff	13 218,9	- 8,78972	- 0,05717	5,9848E-06	0				
727D15	General	- 14 773,7	- 5,09534	0	0	0	17 717,3	- 1 845,07		
727D15	MaxClimb	14 249,6	- 8,103	- 0,0436	0	- 103				
727D15	MaxTakeoff	14 935,3	- 7,459	0,3337	0	- 14,78				
727D15	MaxTkoffHi-Temp	15 524,3	- 7,066	0	0	- 32,38				
727D17	General	- 14 773,7	- 5,09534	0	0	0	17 717,3	- 1 845,07		

ACFTID	Thrust rating	E (lb)	F (lb/kt)	Ga (lb/ft)	Gb (lb/ft ²)	H (lb/ °C)	K1 (lb/EPR)	K2 (lb/EPR ²)	K3 (lb/(N1/√θ))	K4 (lb/(N1/√θ) ²)
727D17	MaxClimb	13 812,7	- 7,52948	0,207702	- 0,000025939	0				
727D17	MaxTakeoff	15 519,8	- 8,46009	0,233373	- 0,000029145	0				
727EM1	MaxClimb	12 029,2	- 7,99864	- 0,05203	5,44617E-06	0				
727EM1	MaxTakeoff	13 218,9	- 8,78972	- 0,05717	5,9848E-06	0				
727EM2	General	- 14 773,7	- 5,09534	0	0	0	17 717,3	- 1 845,07		
727EM2	MaxClimb	14 249,6	- 8,103	- 0,0436	0	- 103				
727EM2	MaxTakeoff	14 935,3	- 7,459	0,3337	0	- 14,78				
727EM2	MaxTkooffHi-Temp	15 524,3	- 7,066	0	0	- 32,38				
727Q15	General	- 14 773,7	- 5,09534	0	0	0	17 717,3	- 1 845,07		
727Q15	MaxClimb	14 249,6	- 8,103	- 0,0436	0	- 103				
727Q15	MaxTakeoff	14 935,3	- 7,459	0,3337	0	- 14,78				
727Q15	MaxTkooffHi-Temp	15 524,3	- 7,066	0	0	- 32,38				
727Q7	General	- 14 205,5	- 4,53212	0	0	0	16 602,8	- 1 403,02		
727Q7	MaxClimb	12 029,2	- 7,99864	- 0,05203	5,44617E-06	0				
727Q7	MaxTakeoff	13 218,9	- 8,78972	- 0,05717	5,9848E-06	0				
727Q9	General	- 14 095,4	- 4,77532	0	0	0	16 666,2	- 1 490,42		
727Q9	MaxClimb	12 746,2	- 8,11613	- 0,00049	- 4,53384E-06	0				
727Q9	MaxTakeoff	13 705,6	- 8,72702	- 0,00053	- 4,8751E-06	0				
727QF	General	- 10 908	- 23,3571	- 0,0723	- 0,00000138	0	10 929,8	2 380,86		
727QF	MaxClimb	11 266	- 9,335	0,169297	- 4,70391E-06	0				
727QF	MaxClimbHi-Temp	13 966	- 9,335	0	0	- 90				
727QF	MaxContHi-Temp	14 687	- 9,335	0	0	- 90				
727QF	MaxContinuous	11 987	- 9,335	0,158001	- 4,70391E-06	0				
727QF	MaxTakeoff	14 100	- 12,25	0,1495	- 0,00001175	0				

ACFTID	Thrust rating	E (lb)	F (lb/kt)	Ga (lb/ft)	Gb (lb/ft ²)	H (lb/ °C)	K1 (lb/EPR)	K2 (lb/EPR ²)	K3 (lb/(N1/√θ))	K4 (lb/(N1/√θ) ²)
727QF	MaxTkoffHi-Temp	16 800	- 12,25	0	0	- 90				
737	General	- 14 095,4	- 4,77532	0	0	0	16 666,2	- 1 490,42		
737	MaxClimb	12 740,1	- 7,93589	- 0,02662	- 4,2762E-07	0				
737	MaxTakeoff	13 847,9	- 8,62596	- 0,02894	- 4,648E-07	0				
737300	General	11 106	- 10,09	- 0,0409	0	0			- 369,8	4,835
737300	MaxClimb	17 383,1	- 15,6072	0,148043	- 0,000001	- 24,2				
737300	MaxClimbHi-Temp	20 363,9	- 17,0452	- 0,06578	- 0,000001	- 119				
737300	MaxTakeoff	19 347	- 25,8689	0,456499	- 0,0000112	- 14,78				
737300	MaxTkoffHi-Temp	21 143,7	- 26,2402	0,398451	- 0,000014	- 79,95				
7373B2	General	11 106	- 10,09	- 0,0409	0	0			- 369,8	4,835
7373B2	MaxClimb	18 623,5	- 16,4797	0,169674	0	- 9,126				
7373B2	MaxClimbHi-Temp	21 906,6	- 17,4327	- 0,07536	0	- 132,5				
7373B2	MaxTakeoff	21 480,7	- 25,888	0,225791	0	- 8,441				
7373B2	MaxTkoffHi-Temp	25 393,2	- 25,7175	- 0,0246	0	- 141,3				
737400	General	21 384	- 13,79	- 0,0435	0	0			- 615,8	6,409
737400	MaxClimb	19 662,2	- 18,221	0,207237	0	0				
737400	MaxClimbHi-Temp	22 875,1	- 18,001	- 0,07615	0	- 124,7				
737400	MaxTakeoff	22 116,3	- 26,0175	0,259442	0	0				
737400	MaxTkoffHi-Temp	26 883,2	- 26,1707	- 0,04324	0	- 159,7				
737500	General	11 106	- 10,09	0,0409	0	0			- 369,8	4,835
737500	MaxClimb	17 530,9	- 16,3556	0,153997	- 0,0000013	- 23,39				
737500	MaxClimbHi-Temp	20 510,5	- 17,1336	- 0,07687	- 0,0000004	- 122,3				

ACFTID	Thrust rating	E (lb)	F (lb/kt)	Ga (lb/ft)	Gb (lb/ft ²)	H (lb/ °C)	K1 (lb/EPR)	K2 (lb/EPR ²)	K3 (lb/(N1/√θ))	K4 (lb/(N1/√θ) ²)
737500	MaxTakeoff	19 629,4	- 26,7504	0,550433	- 0,0000217	- 7,999				
737500	MaxTkoffHi-Temp	22 636,2	- 28,0937	0,225263	0,0000409	- 105,6				
737700	MaxClimb	22 106,7	- 23,7147	0,165546	0,0000065	0				
737700	MaxClimbHi-Temp	29 618,1	- 24,596	- 0,273	0	- 249,1				
737700	MaxTakeoff	23 534,8	- 29,3547	0,308407	0	0				
737700	MaxTkoffHi-Temp	29 335,5	- 28,632	- 0,105	0	- 195,6				
737800	MaxClimb	22 403,5	- 27,2645	0,305603	0	0				
737800	MaxClimbHi-Temp	26 593,3	- 26,293	- 0,078	0	- 174,4				
737800	MaxTakeoff	26 089,1	- 29,1098	0,143559	0	0				
737800	MaxTkoffHi-Temp	30 143,2	- 29,773	- 0,029	0	- 145,2				
737D17	General	- 14 773,7	- 5,09534	0	0	0	17 717,3	- 1 845,07		
737D17	MaxClimb	13 083,2	- 7,13185	0,196733	- 0,000024569	0				
737D17	MaxTakeoff	15 519,8	- 8,46009	0,233373	- 0,000029145	0				
737N17	General	- 14 773,7	- 5,09534	0	0	0	17 717,3	- 1 845,07		
737N17	MaxClimb	13 083,2	- 7,13185	0,196733	- 0,000024569	0				
737N17	MaxTakeoff	15 519,8	- 8,46009	0,233373	- 0,000029145	0				
737N9	General	- 14 095,4	- 4,77532	0	0	0	16 666,2	- 1 490,42		
737N9	MaxClimb	12 740,1	- 7,93589	- 0,02662	- 4,2762E-07	0				
737N9	MaxTakeoff	13 847,9	- 8,62596	- 0,02894	- 4,648E-07	0				
737QN	General	- 14 095,4	- 4,77532	0	0	0	16 666,2	- 1 490,42		
737QN	MaxClimb	12 740,1	- 7,93589	- 0,02662	- 4,2762E-07	0				
737QN	MaxTakeoff	13 847,9	- 8,62596	- 0,02894	- 4,648E-07	0				
74710Q	General	- 141 079	- 11,7298	- 0,02833	0	0	201 105	- 53 843		
74710Q	MaxClimb	36 791,4	- 43,5074	0,3004	- 0,0000092	0				

ACFTID	Thrust rating	E (lb)	F (lb/kt)	Ga (lb/ft)	Gb (lb/ft ²)	H (lb/°C)	K1 (lb/EPR)	K2 (lb/EPR ²)	K3 (lb/(N1/√θ))	K4 (lb/(N1/√θ) ²)
74710Q	MaxTakeoff	42 780,7	- 50,59	0,349279	- 0,000010697	0				
747200	General	- 141 079	- 11,7298	- 0,02833	0	0	201 105	- 53 843		
747200	MaxClimb	36 791,4	- 43,5074	0,3004	- 0,0000092	0				
747200	MaxTakeoff	42 780,7	- 50,59	0,349279	- 0,000010697	0				
74720A	General	- 32 370	- 7,83	- 0,02105	0	0	47 590	0		
74720A	MaxClimb	34 860	- 35	0,4962	0	0				
74720A	MaxTakeoff	40 870	- 40,11	0,4435	0	0				
74720B	General	- 28 110	- 10,05	- 0,03543	0	0	46 375	0		
74720B	MaxClimb	39 594	- 38,08	0,5262	0	0				
74720B	MaxTakeoff	48 866	- 43,68	0,6641	0	0				
747400	General	- 49 250	0	0	0	0	62 210	0		
747400	MaxClimb	44 157,4	- 42,6142	0,635772	0	0				
747400	MaxClimbHi-Temp	56 826,2	- 45,4912	- 0,20856	0	- 392,3				
747400	MaxTakeoff	53 290,5	- 53,434	0,606283	0	0				
747400	MaxTkooffHi-Temp	66 921,4	- 54,5627	- 0,1278	0	- 410,2				
7478	IdleApproach	5 920	- 19,02	0,225	0	0				
7478	MaxClimb	50 523	- 39,8663	0,842437	- 0,000015	0				
7478	MaxClimbHi-Temp	56 739,2	- 27,469	- 0,1411	- 0,000015	- 343,137				
7478	MaxTakeoff	64 247,2	- 66,0662	0,481932	0,000004	0				
7478	MaxTkooffHi-Temp	80 923,7	- 71,3162	- 0,30655	- 0,00001	- 520,464				
747SP	General	- 141 079	- 11,7298	- 0,02833	0	0	201 105	- 53 843		
747SP	MaxClimb	36 791,4	- 43,5074	0,3004	- 0,0000092	0				
747SP	MaxTakeoff	42 780,7	- 50,59	0,349279	- 0,000010697	0				
757300	MaxClimb	29 549,2	- 30,6086	0,398179	0	0				

ACFTID	Thrust rating	E (lb)	F (lb/kt)	Ga (lb/ft)	Gb (lb/ft ²)	H (lb/ °C)	K1 (lb/EPR)	K2 (lb/EPR ²)	K3 (lb/(N1/√θ))	K4 (lb/(N1/√θ) ²)
757300	MaxClimbHi-Temp	36 157	- 30,9643	- 0,16465	0	- 250,7				
757300	MaxTakeoff	40 175,5	- 35,323	- 0,11328	0	0				
757300	MaxTkoffHi-Temp	46 892,4	- 35,6127	- 0,53031	0	- 241,7				
757PW	General	- 44 951	- 0,83	0,0198	0	0	52 972	0		
757PW	MaxClimb	27 775,1	- 27,6876	0,381725	0	0				
757PW	MaxClimbHi-Temp	34 748,3	- 29,9467	- 0,16641	0	- 250,7				
757PW	MaxTakeoff	36 214,8	- 48,2704	0,908044	0	0				
757PW	MaxTkoffHi-Temp	45 592,5	- 49,7383	0,213208	0	- 290,6				
757RR	General	- 44 907	- 21,97	- 0,0589	0	0	46 999	0		
757RR	MaxClimb	30 065,2	- 32,4779	0,397321	0	0				
757RR	MaxClimbHi-Temp	36 735,1	- 32,445	- 0,16871	0	- 258,4				
757RR	MaxTakeoff	37 802,1	- 38,2839	0,527181	0	0				
757RR	MaxTkoffHi-Temp	45 336,5	- 39,1302	- 0,00514	0	- 257,4				
767300	General	- 49 250	0	0	0	0	62 210	0		
767300	MaxClimb	45 480	- 41,9	0,559	0	0				
767300	MaxTakeoff	56 370	- 53	0,251	0	0				
767400	MaxClimb	45 902,7	- 39,5895	0,633446	0	0				
767400	MaxClimbHi-Temp	63 647,5	- 41,082	- 0,55	0	- 562,3				
767400	MaxTakeoff	60 475,4	- 56,8041	0,478788	0	0				
767400	MaxTkoffHi-Temp	72 425,5	- 55,569	- 0,236	0	- 416,2				
767CF6	General	62 790	- 35,03	- 0,1177	0	0			- 1 610,37	14
767CF6	MaxClimb	38 057	- 43,24	0,705	0	0				
767CF6	MaxTakeoff	44 769	- 48,34	0,5	0	0				

ACFTID	Thrust rating	E (lb)	F (lb/kt)	Ga (lb/ft)	Gb (lb/ft ²)	H (lb/°C)	K1 (lb/EPR)	K2 (lb/EPR ²)	K3 (lb/(N1/√θ))	K4 (lb/(N1/√θ) ²)
767JT9	General	- 39 777	- 17,367	- 0,0467	0	0	56 550	0		
767JT9	MaxClimb	38 700	- 34,5	0,49	0	0				
767JT9	MaxTakeoff	43 190	- 38,3	0,876	0	0				
777200	General	32 710	0	0	0	0			- 1 258	16,16
777200	MaxClimb	67 093,7	- 85,7553	1,8498	- 0,000076	0				
777200	MaxClimbHi-Temp	82 096,7	- 72,2859	- 0,32818	- 0,0000179	- 637				
777200	MaxTakeoff	93 672,6	- 122,251	1,1818	- 0,0000806	0				
777200	MaxTkoffHi-Temp	114 758,6	- 125,38	- 0,159	- 0,0000261	- 702,4				
777300	MaxClimb	64 636,2	- 70,833	0,880073	0	0				
777300	MaxClimbHi-Temp	90 015,1	- 70,745	- 0,852	0	- 823				
777300	MaxTakeoff	87 833,8	- 97,7894	0,27543	0	0				
777300	MaxTkoffHi-Temp	103 835,2	- 97,831	- 0,632	0	- 549,1				
7773ER	IdleApproach	8 950	- 27,25	0,131	0	0				
7773ER	MaxClimb	92 110	- 119	1,14	- 0,000007	0				
7773ER	MaxClimbHi-Temp	96 550	- 69,4	- 0,542	- 0,00005	- 533				
7773ER	MaxTakeoff	112 250	- 120	0,713	- 0,00011	0				
7878R	IdleApproach	3 425	- 12,03	0,0955	0	0				
7878R	MaxClimb	61 142,6	- 78,8116	1,219801	- 0,000039	0				
7878R	MaxClimbHi-Temp	65 000	- 55	0,1	- 0,00002	- 404,274				
7878R	MaxTakeoff	71 214,6	- 93,4796	0,652462	0,000002	0				
7878R	MaxTkoffHi-Temp	86 784,2	- 92	- 0,27021	- 0,00001	- 520,488				
A300-622R	General	- 148 952	- 6,71	- 0,03	0	0	203 740	- 50 104,7		

ACFTID	Thrust rating	E (lb)	F (lb/kt)	Ga (lb/ft)	Gb (lb/ft ²)	H (lb/ °C)	K1 (lb/EPR)	K2 (lb/EPR ²)	K3 (lb/(N1/√θ))	K4 (lb/(N1/√θ) ²)
A300-622R	IdleApproach	8 432,8	- 47,7662	0,750523	- 0,000059071	0				
A300-622R	IdleApproachHi-Temp	8 432,8	- 47,7662	0,750523	- 0,000059071	0				
A300-622R	MaxClimb	44 457,2	- 45,778	0,735506	- 0,000015775	0				
A300-622R	MaxClimbHi-Temp	52 183,7	- 44,1929	0	0	- 271				
A300-622R	MaxTakeoff	56 307,1	- 50,9157	0,405632	- 2,0986E-06	0				
A300-622R	MaxTkoffHi-Temp	61 250,3	- 51,5373	0	0	- 192				
A300B4-203	General	- 132 687	- 30,4092	- 0,10796	4,02686E-07	0			2 535,75	- 8,23842
A300B4-203	MaxClimb	43 416,5	- 35	- 0,12523	6,27209E-07	0				
A300B4-203	MaxTakeoff	49 336,9	- 39,8243	- 0,14231	7,12738E-07	0				
A310-304	General	41 317	- 32,9	- 0,0857	- 0,0000016	0	- 1 131,6	11,8		
A310-304	IdleApproach	4 613,2	- 22,0136	0,082133	- 2,7376E-06	0				
A310-304	IdleApproachHi-Temp	4 613,2	- 22,0136	0,082133	- 2,7376E-06	0				
A310-304	MaxClimb	42 008	- 49,5706	1,64076	- 0,000043059	0				
A310-304	MaxClimbHi-Temp	55 143,3	- 37,4839	0	0	- 505				
A310-304	MaxTakeoff	50 530,5	- 51,1538	1,26398	- 0,000012839	0				
A310-304	MaxTkoffHi-Temp	71 457,7	- 50,7768	0	0	- 608				
A319-131	General	- 105 513	- 6,58	0,006828	- 8,055E-07	0	149 900	- 42 300		
A319-131	IdleApproach	1 219,5	- 7,22737	0,154266	- 0,000007955	0				
A319-131	IdleApproachHi-Temp	1 219,5	- 7,22737	0,154266	- 0,000007955	0				
A319-131	MaxClimb	14 957,2	1,71654	0,442593	- 0,000013824	0				
A319-131	MaxClimbHi-Temp	12 977,6	18,59062	0	0	- 78,7				
A319-131	MaxTakeoff	21 435,4	- 21,3236	0,309465	1,26125E-05	0				

ACFTID	Thrust rating	E (lb)	F (lb/kt)	Ga (lb/ft)	Gb (lb/ft ²)	H (lb/ °C)	K1 (lb/EPR)	K2 (lb/EPR ²)	K3 (lb/(N1/√θ))	K4 (lb/(N1/√θ) ²)
A319-131	MaxTkoffHi-Temp	23 853,8	- 18,7311	0	0	- 76,8				
A320-211	General	24 380	- 18,534	- 0,07842	- 2,509E-07	0			- 669,457	6,9451
A320-211	IdleApproach	2 858,8	- 14,7325	0,096537	- 6,7861E-06	0				
A320-211	IdleApproachHi-Temp	2 858,8	- 14,7325	0,096537	- 6,7861E-06	0				
A320-211	MaxClimb	16 859,1	- 4,3786	0,183576	2,9851E-06	0				
A320-211	MaxClimbHi-Temp	19 148,5	- 6,50173	0	0	- 95				
A320-211	MaxTakeoff	23 652,9	- 22,9338	0,295879	- 5,4631E-06	0				
A320-211	MaxTkoffHi-Temp	27 385	- 23,3	0	0	- 132				
A320-232	General	- 65 083,3	- 7,25	- 0,01918	2,575E-08	0	87 817,6	- 18 693,1		
A320-232	IdleApproach	1 138,9	- 6,52566	0,1667	- 9,2579E-06	0				
A320-232	IdleApproachHi-Temp	1 138,9	- 6,52566	0,1667	- 9,2579E-06	0				
A320-232	MaxClimb	15 539,2	- 4,08932	0,438331	- 0,00001439	0				
A320-232	MaxClimbHi-Temp	14 111,4	10,67953	0	0	- 82,2				
A320-232	MaxTakeoff	24 746,2	- 25,2473	0,304165	9,2451E-06	0				
A320-232	MaxTkoffHi-Temp	29 506,5	- 24,4165	0	0	- 139				
A321-232	General	- 26 190,2	- 6,6	- 0,0197	- 3,408E-07	0	33 032,2	0		
A321-232	IdleApproach	1 274,1	- 7,34054	0,175187	- 0,000011478	0				
A321-232	IdleApproachHi-Temp	1 274,1	- 7,34054	0,175187	- 0,000011478	0				
A321-232	MaxClimb	21 870,8	- 21,4867	0,380647	- 5,5566E-06	0				
A321-232	MaxClimbHi-Temp	24 158,5	- 16,8504	0	0	- 147				
A321-232	MaxTakeoff	28 636,4	- 26,7318	0,249782	- 3,9163E-06	0				

ACFTID	Thrust rating	E (lb)	F (lb/kt)	Ga (lb/ft)	Gb (lb/ft ²)	H (lb/ °C)	K1 (lb/EPR)	K2 (lb/EPR ²)	K3 (lb/(N1/√θ))	K4 (lb/(N1/√θ) ²)
A321-232	MaxTkoffHi-Temp	31 608,2	- 25,9736	0	0	- 114				
A330-301	General	- 36 339,3	- 31,32	- 0,1297	0	0			484,645	4,0056
A330-301	IdleApproach	4 572,4	- 26,0005	0,013461	2,8669E-06	0				
A330-301	IdleApproachHi-Temp	4 572,4	- 26,0005	0,013461	2,8669E-06	0				
A330-301	MaxClimb	34 249,9	25,9859	0,764157	- 8,1437E-07	0				
A330-301	MaxClimbHi-Temp	46 667,8	10,51272	0	0	- 346				
A330-301	MaxTakeoff	61 384,5	- 48,4678	0,582821	- 6,2628E-06	0				
A330-301	MaxTkoffHi-Temp	69 058	- 46,465	0	0	- 288				
A330-343	General	- 127 410	- 9,31	- 0,0386	0,000000569	0	162 922	- 29 498,6		
A330-343	IdleApproach	3 134,3	- 13,0338	0,085938	1,7155E-06	0				
A330-343	IdleApproachHi-Temp	3 134,3	- 13,0338	0,085938	1,7155E-06	0				
A330-343	MaxClimb	44 462	- 12,031	0,711026	5,12762E-06	0				
A330-343	MaxClimbHi-Temp	63 522,4	- 50,7504	0	0	- 411				
A330-343	MaxTakeoff	69 831	- 77,9676	0,882955	- 0,000026894	0				
A330-343	MaxTkoffHi-Temp	85 732,2	- 78,8957	0	0	- 451				
A340-211	General	19 716	- 17,65	- 0,0878	0	0			- 590,77	7,341
A340-211	IdleApproach	4 019,5	- 20,508	- 0,02271	1,16972E-05	0				
A340-211	IdleApproachHi-Temp	4 019,5	- 20,508	- 0,02271	1,16972E-05	0				
A340-211	MaxClimb	26 802,9	- 28,8264	0,31673	3,50144E-06	0				
A340-211	MaxClimbHi-Temp	31 091,8	- 31,4492	0	0	- 160				
A340-211	MaxTakeoff	29 929,8	- 30,7732	0,29922	- 4,1757E-06	0				

ACFTID	Thrust rating	E (lb)	F (lb/kt)	Ga (lb/ft)	Gb (lb/ft ²)	H (lb/ °C)	K1 (lb/EPR)	K2 (lb/EPR ²)	K3 (lb/(N1/√θ))	K4 (lb/(N1/√θ) ²)
A340-211	MaxTkoffHi-Temp	34 594,4	- 30,094	0	0	- 175				
A340-642	IdleApproach	6 529,4	- 29,9521	0,272155	- 0,000020281	0				
A340-642	IdleApproachHi-Temp	6 529,4	- 29,9521	0,272155	- 0,000020281	0				
A340-642	MaxClimb	42 621,6	- 44,2784	0,484124	2,668E-07	0				
A340-642	MaxClimbHi-Temp	50 112	- 60,5262	0	0	- 212				
A340-642	MaxTakeoff	55 248,1	- 61,4744	0,506968	- 9,6324E-06	0				
A340-642	MaxTkoffHi-Temp	63 276,8	- 59,6458	0	0	- 300				
A380-841	IdleApproach	10 914,8	- 31,2899	- 2,1424	0,000260636	0				
A380-841	IdleApproachHi-Temp	10 914,8	- 31,2899	- 2,1424	0,000260636	0				
A380-841	MaxClimb	63 586,2	- 53,9292	1,23082	- 0,00003343	0				
A380-841	MaxClimbHi-Temp	72 974,3	- 52,6993	0	0	- 420				
A380-841	MaxTakeoff	71 176,1	- 84,4052	0,220679	0,000428339	0				
A380-841	MaxTkoffHi-Temp	90 820,8	- 94,5354	0	0	- 610				
A380-861	IdleApproach	8 921,7	- 30,2153	- 0,87777	0,000104691	0				
A380-861	IdleApproachHi-Temp	8 921,7	- 30,2153	- 0,87777	0,000104691	0				
A380-861	MaxClimb	66 053,2	- 61,754	0,977183	- 0,000025178	0				
A380-861	MaxClimbHi-Temp	73 729,7	- 65,1895	0	0	- 324				
A380-861	MaxTakeoff	70 053,6	- 76,0931	0,838794	- 0,000010766	0				
A380-861	MaxTkoffHi-Temp	83 320,5	- 82,3362	0	0	- 432				
BAC111	MaxClimb	9 827,9	- 5,89674	- 0,01966	0	0				

ACFTID	Thrust rating	E (lb)	F (lb/kt)	Ga (lb/ft)	Gb (lb/ft ²)	H (lb/ °C)	K1 (lb/EPR)	K2 (lb/EPR ²)	K3 (lb/(N1/√θ))	K4 (lb/(N1/√θ) ²)
BAC111	MaxTakeoff	11 168,1	- 6,70084	- 0,02234	0	0				
BAE146	General	- 13 783	- 9,9585	0,056057	- 1,23124E-05	0			304,295	- 0,84327
BAE146	MaxClimb	6 339,4	- 9,9585	0,056057	- 0,0000035	0				
BAE146	MaxTakeoff	6 542,4	- 9,9585	0,056057	- 0,0000035	0				
BAE300	General	- 13 783	- 9,9585	0,056057	- 1,23124E-05	0			304,295	- 0,84327
BAE300	MaxClimb	6 339,4	- 9,9585	0,056057	- 0,0000035	0				
BAE300	MaxTakeoff	6 542,4	- 9,9585	0,056057	- 0,0000035	0				
CIT3	MaxClimb	2 987,4	- 3,4992	0,06123	- 1,1664E-06	0				
CIT3	MaxTakeoff	3 319,3	- 3,888	0,068032	- 0,000001296	0				
CL600	MaxClimb	5 543,3	- 5,6542	0,08442	0	0				
CL600	MaxTakeoff	6 159,2	- 6,2824	0,0938	0	0				
CL601	MaxClimb	6 517,3	- 6,6476	0,09776	0	0				
CL601	MaxTakeoff	7 241,4	- 7,3862	0,10862	0	0				
CNA208	MaxClimb	2 953,9	- 8,581	- 0,00453	- 7,2035E-07	- 1,44				
CNA208	MaxTakeoff	3 245,2	- 11,69	- 0,01053	- 6,777E-07	- 1,62				
CNA500	General	1 743,1	- 1,64678	- 0,00201	- 1,5642E-07	0			- 49,6794	0,545
CNA500	MaxClimb	1 919,5	- 1,99614	0,0615	- 2,40502E-06	0				
CNA500	MaxTakeoff	2 132,8	- 2,21793	0,068333	- 2,67224E-06	0				
CNA510	General	4 234,6	- 1,68388	0,001047	- 5,78019E-08	0			- 103,817	0,811333
CNA510	MaxClimb	1 486	- 1,60533	0	- 1,04748E-07	0				
CNA510	MaxTakeoff	1 492,8	- 1,87734	0	- 2,55208E-06	0				
CNA525C	General	1 528,4	- 2,83667	- 0,00013	2,55648E-07	0			- 51,50512788	0,724013467

ACFTID	Thrust rating	E (lb)	F (lb/kt)	Ga (lb/ft)	Gb (lb/ft ²)	H (lb/ °C)	K1 (lb/EPR)	K2 (lb/EPR ²)	K3 (lb/(N1/√θ))	K4 (lb/(N1/√θ) ²)
CNA525C	MaxClimb	3 001,7	- 2,38854	0,004585	- 1,4045E-07	0				
CNA525C	MaxTakeoff	3 464,1	- 2,5254	0,001981	- 1,46353E-06	0				
CNA55B	General	1 373,8	- 2,2903	- 8,9E-05	3,2273E-08	0			- 44,861	0,66327
CNA55B	MaxClimb	2 323,1	- 2,4386	0,002159	- 2,1456E-07	0				
CNA55B	MaxTakeoff	2 658,7	- 2,6269	- 0,00359	1,7262E-07	0				
CNA560E	General	1 533,4	- 2,49247	0,011973	- 6,90894E-07	0			- 53,9835	0,839574
CNA560E	MaxClimb	3 194,3	- 2,53358	0,028038	2,70832E-07	0				
CNA560E	MaxTakeoff	3 316,5	- 2,7005	0,04349	- 6,52616E-07	0				
CNA560U	MaxClimb	2 597,5	- 2,22178	0,023781	6,12239E-08	0				
CNA560U	MaxTakeoff	2 920	- 2,0264	0,025133	2,95314E-07	0				
CNA560XL	MaxClimb	3 454,5	- 3,98132	- 0,0704	0	0				
CNA560XL	MaxTakeoff	3 838,3	- 4,42368	- 0,07823	0	0				
CNA680	General	2 904,8	- 4,80092	- 0,00174	5,62892E-07	0			- 101,327	1,3401
CNA680	MaxClimb	5 520,2	- 5,32711	- 0,02377	1,89918E-06	0				
CNA680	MaxTakeoff	5 683	- 6,55907	- 0,00159	8,72971E-07	0				
CNA750	General	4 778,6	- 6,56521	0,000671	- 4,11321E-07	0			- 146,712	1,9748
CNA750	MaxClimb	6 097,8	- 7,0102	- 0,00528	3,74689E-08	0				
CNA750	MaxTakeoff	6 127,8	- 7,07624	- 0,00394	3,95764E-08	0				
CONCRD	MaxClimb	33 252,1	- 26,6	0,2328	0	0				
CONCRD	MaxTakeoff	39 653	- 31,722	0,2776	0	0				
CRJ9-ER	General	6 087,3	- 9,35507	- 0,04736	1,55476E-07	- 1,4767			- 183,9266	2,785981
CRJ9-ER	IdleApproach	1 163,1	- 4,5855	- 0,0238	1,63611E-06	- 0,0249				
CRJ9-ER	MaxClimb	10 438,3	- 9,64192	0,15855	- 3,00077E-07	- 1,3095				
CRJ9-ER	MaxClimbHi-Temp	12 973,4	- 9,57675	- 0,05589	3,05523E-07	- 100,415				
CRJ9-ER	MaxTakeoff	13 260,6	- 16,6244	0,19849	- 7,00045E-06	- 1,6224				

ACFTID	Thrust rating	E (lb)	F (lb/kt)	Ga (lb/ft)	Gb (lb/ft ²)	H (lb/ °C)	K1 (lb/EPR)	K2 (lb/EPR ²)	K3 (lb/(N1/√θ))	K4 (lb/(N1/√θ) ²)
CRJ9-ER	MaxTkooffHi-Temp	16 247,3	- 17,4575	0,077341	- 1,06353E-05	- 109,219				
CRJ9-LR	General	6 087,3	- 9,35507	- 0,04736	1,55476E-07	- 1,4767			- 183,9266	2,785981
CRJ9-LR	IdleApproach	1 163,1	- 4,5855	- 0,0238	1,63611E-06	- 0,0249				
CRJ9-LR	MaxClimb	10 438,3	- 9,64192	0,15855	- 3,00077E-07	- 1,3095				
CRJ9-LR	MaxClimbHi-Temp	12 973,4	- 9,57675	- 0,05589	3,05523E-07	- 100,415				
CRJ9-LR	MaxTakeoff	13 260,6	- 16,6244	0,19849	- 7,00045E-06	- 1,6224				
CRJ9-LR	MaxTkooffHi-Temp	16 247,3	- 17,4575	0,077341	- 1,06353E-05	- 109,219				
DC1010	General	25 027,6	- 27,4313	- 0,07828	0	0			- 694,556	8,02362
DC1010	MaxClimb	30 596	- 28,4416	- 0,10164	5,0902E-07	0				
DC1010	MaxTakeoff	35 985,4	- 30,9909	- 0,11075	5,5465E-07	0				
DC1030	MaxClimb	38 520	- 29,38	0,49	0	0				
DC1030	MaxTakeoff	49 310	- 42,42	0,61	0	0				
DC1040	General	- 143 602	- 14,4996	- 0,05026	0	0	204 567	- 54 761,9		
DC1040	MaxClimb	34 087,9	- 12,9859	- 0,04641	2,3241E-07	0				
DC1040	MaxTakeoff	41 594,9	- 22,3071	- 0,07971	3,9923E-07	0				
DC850	General	- 22 582,8	- 6,58409	- 0,02081	0	0	29 070,9	- 4 341,84		
DC850	MaxClimb	14 243,5	- 5,6565	- 0,02021	1,0123E-07	0				
DC850	MaxTakeoff	15 670,3	- 5,8955	- 0,02107	1,0551E-07	0				
DC860	General	- 27 959,5	- 6,35297	- 0,01835	0	0	35 850,3	- 6 157,74		
DC860	MaxClimb	15 558,7	- 7,2339	- 0,02585	1,2947E-07	0				
DC860	MaxTakeoff	16 740,5	- 4,9394	- 0,01765	8,8401E-08	0				
DC870	General	11 106	- 10,09	- 0,0409	0	0			- 369,8	4,835
DC870	MaxClimb	18 859	- 17,91	0,1953	0	- 2,034				
DC870	MaxTakeoff	20 758	- 20,65	0,2173	0	0				

ACFTID	Thrust rating	E (lb)	F (lb/kt)	Ga (lb/ft)	Gb (lb/ft ²)	H (lb/°C)	K1 (lb/EPR)	K2 (lb/EPR ²)	K3 (lb/(N1/√θ))	K4 (lb/(N1/√θ) ²)
DC8QN	General	- 27 959,5	- 6,35297	- 0,01835	0	0	35 850,3	- 6 157,74		
DC8QN	MaxClimb	15 558,7	- 7,2339	- 0,02585	1,2947E-07	0				
DC8QN	MaxTakeoff	16 740,5	- 4,9394	- 0,01765	8,8401E-08	0				
DC910	General	- 10 596,5	- 1,51369	- 0,00525	0	0	11 541,7	162,698		
DC910	MaxClimb	11 194,3	- 3,0274	- 0,01082	5,4181E-08	0				
DC910	MaxTakeoff	12 308,2	- 0,478	0,001708	8,55E-09	0				
DC930	General	- 13 523,2	- 2,66888	- 0,00925	0	0	15 803,6	- 1 257,94		
DC930	MaxClimb	11 561,8	- 2,94773	- 0,01053	5,2756E-08	0				
DC930	MaxTakeoff	12 972	- 2,31038	- 0,00826	4,1349E-08	0				
DC93LW	General	- 13 523,2	- 2,66888	- 0,00925	0	0	15 803,6	- 1 257,94		
DC93LW	MaxClimb	11 561,8	- 2,94773	- 0,01053	5,2756E-08	0				
DC93LW	MaxTakeoff	12 972	- 2,31038	- 0,00826	4,1349E-08	0				
DC950	General	- 13 523,2	- 2,66888	- 0,00925	0	0	15 803,6	- 1 257,94		
DC950	MaxClimb	12 365,4	- 2,54939	- 0,00911	4,5627E-08	0				
DC950	MaxTakeoff	14 698,5	- 2,13511	- 0,00763	3,8212E-08	0				
DC95HW	General	- 13 523,2	- 2,66888	- 0,00925	0	0	15 803,6	- 1 257,94		
DC95HW	MaxClimb	12 365,4	- 2,54939	- 0,00911	4,5627E-08	0				
DC95HW	MaxTakeoff	14 698,5	- 2,13511	- 0,00763	3,8212E-08	0				
DC9Q7	General	- 10 596,5	- 1,51369	- 0,00525	0	0	11 541,7	162,698		
DC9Q7	MaxClimb	11 194,3	- 3,0274	- 0,01082	5,4181E-08	0				
DC9Q7	MaxTakeoff	12 308,2	- 0,478	0,001708	8,55E-09	0				
DC9Q9	General	- 13 523,2	- 2,66888	- 0,00925	0	0	15 803,6	- 1 257,94		
DC9Q9	MaxClimb	11 561,8	- 2,94773	- 0,01053	5,2756E-08	0				
DC9Q9	MaxTakeoff	12 972	- 2,31038	- 0,00826	4,1349E-08	0				
DHC8	General	2 010,7	- 19,409	0,07743	0	0			54,6666	- 0,0828
DHC8	MaxClimb	6 323,6	- 21,4445	0,088232	0	0				

ACFTID	Thrust rating	E (lb)	F (lb/kt)	Ga (lb/ft)	Gb (lb/ft ²)	H (lb/ °C)	K1 (lb/EPR)	K2 (lb/EPR ²)	K3 (lb/(N1/√θ))	K4 (lb/(N1/√θ) ²)
DHC8	MaxTakeoff	7 026,2	- 23,8272	0,098036	0	0				
DHC830	General	1 623,1	- 18,411	0,075104	0	0			72,6356	- 0,17951
DHC830	MaxClimb	6 679	- 21,9919	0,090305	0	0				
DHC830	MaxTakeoff	7 421,1	- 24,4354	0,100339	0	0				
DO228	MaxClimb	2 571	- 7,9721	0,07004	- 4,9292E-06	0				
DO228	MaxTakeoff	2 524,3	- 8,067	0,06042	- 6,8678E-06	0				
DO328	MaxClimb	7 752,5	- 23,2	0,225	- 0,0000158	0				
DO328	MaxTakeoff	8 138,2	- 28,1	0,199	- 0,000021	0				
ECLIPSE500	MaxClimb	947,7	- 0,73662	0,018307	2,63346E-07	- 0,0571				
ECLIPSE500	MaxClimbHi-Temp	1 077,4	- 1,20966	- 0,00912	1,28125E-07	- 9,84248				
ECLIPSE500	MaxTakeoff	1 039,2	- 1,57439	0,034769	- 0,000002274	- 0,0323				
ECLIPSE500	MaxTkooffHi-Temp	1 258,9	- 1,6144	- 0,00748	3,13285E-08	- 10,7499				
ECLIPSE500	ReduceClimb	1 084,2	- 1,38862	0,009974	7,08687E-08	0,048579				
ECLIPSE500	ReduceClimbHi-Temp	1 168,6	- 1,50732	- 0,01586	3,07776E-07	- 11,2558				
EMB120	MaxClimb	4 668	- 11,932	0,0664	0	- 5,663				
EMB120	MaxTakeoff	5 212	- 12,45	0,0728	0	- 6,87				
EMB145	MaxClimb	5 554,3	- 6,86092	0,065416	0	- 4,036				
EMB145	MaxTakeoff	7 499,5	- 9,12812	0,045563	0	- 22,89				
EMB14L	MaxClimb	6 432,5	- 7,56929	0,069004	0	- 5,419				
EMB14L	MaxTakeoff	7 246,1	- 8,61031	0,232825	0	- 0,9689				
EMB170	IdleApproach	945	- 3,5	- 0,01	0	0				
EMB170	MaxClimb	11 716	- 13,423	0,25	- 0,000019	0				

ACFTID	Thrust rating	E (lb)	F (lb/kt)	Ga (lb/ft)	Gb (lb/ft ²)	H (lb/ °C)	K1 (lb/EPR)	K2 (lb/EPR ²)	K3 (lb/(N1/√θ))	K4 (lb/(N1/√θ) ²)
EMB170	MaxTakeoff	13 350	- 17,43	0,1875	- 0,000013	- 4,47				
EMB175	IdleApproach	945	- 3,5	- 0,01	0	0				
EMB175	MaxClimb	11 716	- 13,423	0,25	- 0,000019	0				
EMB175	MaxTakeoff	13 350	- 17,43	0,1875	- 0,000013	- 4,47				
EMB190	IdleApproach	1 080	- 3,65	0,011	0	0				
EMB190	MaxClimb	15 137	- 14,3	0,239	- 0,0000187	0				
EMB190	MaxTakeoff	17 499	- 18,99	0,3207	- 0,000021	- 4,29				
EMB195	IdleApproach	1 080	- 3,65	0,011	0	0				
EMB195	MaxClimb	15 137	- 14,3	0,239	- 0,0000187	0				
EMB195	MaxTakeoff	17 499	- 18,99	0,3207	- 0,000021	- 4,29				
F10062	MaxClimb	10 472	- 9,57	0,137	0	0				
F10062	MaxTakeoff	13 551	- 16,56	0,2804	0	0				
F10065	MaxClimb	10 970	- 10,52	0,1238	0	0				
F10065	MaxTakeoff	14 814	- 16,72	0,065	0	0				
F28MK2	MaxClimb	8 408	- 4,72	0,1048	0	0				
F28MK2	MaxTakeoff	9 851	- 7,68	0,0889	0	0				
F28MK4	MaxClimb	8 459	- 4,874	0,0997	0	0				
F28MK4	MaxTakeoff	9 905	- 7,445	0,0765	0	0				
FAL20	MaxClimb	4 102	- 2,3831	- 0,11465	1,02126E-05	0				
FAL20	MaxTakeoff	4 017,4	- 3,4567	0,058024	- 2,49247E-06	0				
GII	MaxClimb	9 827,9	- 5,89674	- 0,01966	0	0				
GII	MaxTakeoff	11 324	- 9,697	0,1539	- 0,000004	0				

ACFTID	Thrust rating	E (lb)	F (lb/kt)	Ga (lb/ft)	Gb (lb/ft ²)	H (lb/ °C)	K1 (lb/EPR)	K2 (lb/EPR ²)	K3 (lb/(N1/√θ))	K4 (lb/(N1/√θ) ²)
GII	MaxTkoffHi-Temp	12 833	- 8,35	0,0346	- 0,000004	- 74,58				
GII	ReduceClimb	6 030	0	- 0,0081	0,0000002	0				
GII	ReduceTakeoff	9 060	- 7,27	0,121	- 0,000003	0				
GII	ReduTkoffHi-Temp	10 266	- 6,25	0,0277	- 0,0000003	- 59,7				
GIB	MaxClimb	9 827,9	- 5,89674	- 0,01966	0	0				
GIB	MaxTakeoff	11 324	- 9,697	0,1539	- 0,000004	0				
GIB	MaxTkoffHi-Temp	12 833	- 8,35	0,0346	- 0,000004	- 74,58				
GIB	ReduceClimb	5 369	0	- 0,0081	0	0				
GIB	ReduceTakeoff	9 060	- 7,27	0,121	- 0,000003	0				
GIB	ReduTkoffHi-Temp	10 266	- 6,25	0,0277	- 0,0000003	- 59,7				
GIV	MaxClimb	10 770	- 10,96	0,1784	- 0,000001	0				
GIV	MaxClimbHi-Temp	11 805	- 9,4	- 0,0624	0	- 89				
GIV	MaxTakeoff	13 725	- 18,2	0,3189	- 0,00002	0				
GIV	MaxTkoffHi-Temp	17 129	- 17,6	- 0,0472	0,0000003	- 114				
GV	MaxClimb	12 400	- 11,6	0,12	0	0				
GV	MaxClimbHi-Temp	14 900	- 11,2	- 0,11	0	- 107				
GV	MaxTakeoff	14 600	- 18,86	0,1649	0	0				
GV	MaxTkoffHi-Temp	18 970	- 18,4	- 0,115	0	- 126,5				
IA1125	MaxClimb	3 114,4	- 3,4992	0,04125	- 2,81988E-06	0				
IA1125	MaxTakeoff	3 460,5	- 3,888	0,045834	- 3,1332E-06	0				
L1011	General	- 80 222,2	- 25,0263	0	0	0	92 893,5	- 10 186,1		

ACFTID	Thrust rating	E (lb)	F (lb/kt)	Ga (lb/ft)	Gb (lb/ft ²)	H (lb/°C)	K1 (lb/EPR)	K2 (lb/EPR ²)	K3 (lb/(N1/√θ))	K4 (lb/(N1/√θ) ²)
L1011	MaxClimb	34 204,8	- 43,8172	0,270193	2,0153E-06	0				
L1011	MaxTakeoff	40 720	- 52,1633	0,321659	2,3992E-06	0				
L10115	MaxClimb	39 532,9	- 44,0258	0,27148	2,02494E-06	0				
L10115	MaxTakeoff	46 840	- 52,1633	0,321659	2,3992E-06	0				
LEAR25	MaxClimb	2 560,9	- 1,8352	- 0,01509	1,95912E-06	0				
LEAR25	MaxTakeoff	2 845,4	- 2,03911	- 0,01677	2,1768E-06	0				
LEAR35	MaxClimb	3 071	- 3,4992	- 0,00397	1,38915E-06	0				
LEAR35	MaxTakeoff	3 412,2	- 3,888	- 0,00441	1,5435E-06	0				
MD11GE	MaxClimb	47 037	- 45,71	0,854	0	- 368,1				
MD11GE	MaxTakeoff	57 156	- 42,73	0,303	0	- 357,5				
MD11PW	MaxClimb	51 197	- 59,27	0,416	0	- 357				
MD11PW	MaxTakeoff	57 661	- 51,3	0,513	0	- 426,6				
MD81	General	- 15 384	- 10	0,019	0	0	17 917	0		
MD81	MaxClimb	18 040,9	- 8,83022	- 0,02993	0	- 114,3				
MD81	MaxClimbHi-Temp	21 047,1	- 12,8373	- 0,07163	0	- 151,8				
MD81	MaxTakeoff	18 810,5	- 11,1271	0,092622	0	- 2,101				
MD81	MaxTkooffHi-Temp	22 678,5	- 14,546	- 0,05823	0	- 138,4				
MD82	General	- 13 488	- 10	0,025	0	0	16 750	0		
MD82	MaxClimb	16 810,1	- 5,36467	0,048334	0	- 60,8				
MD82	MaxClimbHi-Temp	22 606,4	- 13,9975	- 0,09177	0	- 168,1				
MD82	MaxTakeoff	19 344,5	- 15,5531	0,333164	0	- 1,031				
MD82	MaxTkooffHi-Temp	24 452	- 16,6869	0,005711	0	- 162,5				

ACFTID	Thrust rating	E (lb)	F (lb/kt)	Ga (lb/ft)	Gb (lb/ft ²)	H (lb/ °C)	K1 (lb/EPR)	K2 (lb/EPR ²)	K3 (lb/(N1/√θ))	K4 (lb/(N1/√θ) ²)
MD83	General	- 13 845	- 13,33	0,019	0	0	17 500	0		
MD83	MaxClimb	18 075,2	- 7,63873	0,058915	0	- 64,7				
MD83	MaxClimbHi-Temp	23 181,6	- 13,4908	- 0,09344	0	- 164				
MD83	MaxTakeoff	20 080,8	- 11,9047	0,191099	0	- 4,078				
MD83	MaxTkoffHi-Temp	25 460,4	- 15,5681	- 0,05468	0	- 176,1				
MD9025	General	- 31 899	- 8,5718	- 0,0276	0	0	37 206	0		
MD9025	MaxClimb	23 881	- 30,625	0,2551	0	0				
MD9025	MaxClimbHi-Temp	27 078,4	- 30,625	0	0	- 213,2				
MD9025	MaxTakeoff	23 066	- 23,5769	0,3147	0	0				
MD9025	MaxTkoffHi-Temp	28 697,1	- 23,5769	0	0	- 225,2				
MD9028	General	- 31 899	- 8,5718	- 0,0276	0	0	37 206	0		
MD9028	MaxClimb	23 421	- 26,5453	0,2599	0	0				
MD9028	MaxClimbHi-Temp	26 678,6	- 26,5453	0	0	- 217,2				
MD9028	MaxTakeoff	25 656	- 25,3418	0,2419	0	0				
MD9028	MaxTkoffHi-Temp	30 520	- 25,3418	0	0	- 194,6				
MU3001	General	1 743,1	- 1,64678	- 0,00201	- 1,5642E-07	0			- 49,6794	0,545
MU3001	MaxClimb	1 919,5	- 1,99614	0,0615	- 2,40502E-06	0				
MU3001	MaxTakeoff	2 132,8	- 2,21793	0,068333	- 2,67224E-06	0				
PA42	MaxClimb	2 295,2	- 6,6307	0,041917	5,8567E-07	0				
PA42	MaxTakeoff	2 219,6	- 5,9898	0,044468	2,8008E-07	0				

Table I-8

Propeller engine coefficients

ACFT_ID	Thrust rating	Propeller Efficiency	Installed Net Propulsive Power (hp)
BEC58P	MaxClimb	0,90	261,3
BEC58P	MaxTakeoff	0,90	310,0
CNA172	MaxClimb	0,69	140,0
CNA172	MaxTakeoff	0,67	155,0
CNA182	MaxClimb	0,78	189,8
CNA182	MaxTakeoff	0,75	222,4
CNA206	MaxClimb	0,77	234,0
CNA206	MaxTakeoff	0,70	300,0
CNA20T	MaxClimb	0,77	238,0
CNA20T	MaxTakeoff	0,69	310,0
CNA441	MaxClimb	0,90	620,0
CNA441	MaxTakeoff	0,90	635,5
CVR580	MaxClimb	0,85	3 344,0
CVR580	MaxTakeoff	0,85	3 800,0
DC3	MaxClimb	0,85	1 130,0
DC3	MaxTakeoff	0,85	1 302,0
DC6	MaxClimb	0,90	1 750,0
DC6	MaxTakeoff	0,90	1 900,0
DHC6	MaxClimb	0,90	557,5
DHC6	MaxTakeoff	0,90	587,0
DHC6QP	MaxClimb	0,90	557,5
DHC6QP	MaxTakeoff	0,90	587,0
DHC7	MaxClimb	0,90	846,0
DHC7	MaxTakeoff	0,90	940,0
HS748A	MaxClimb	0,90	1 805,0
HS748A	MaxTakeoff	0,90	2 006,0
L188	MaxClimb	0,90	3 180,0
L188	MaxTakeoff	0,90	3 460,0
PA30	MaxClimb	0,80	130,5
PA30	MaxTakeoff	0,80	139,5
SD330	MaxClimb	0,90	972,0
SD330	MaxTakeoff	0,90	1 080,0
SF340	MaxClimb	0,90	1 587,0
SF340	MaxTakeoff	0,90	1 763,0

Table I-9

Noise power distance data (NPD data)

NPD_ID	Noise metric	Op type	Power setting (the 'Power Parameter' field in the 'Aircraft' table specifies the power setting type and unit)	L_200ft	L_400ft	L_630ft	L_1000ft	L_2000ft	L_4000ft	L_6300ft	L_10000ft	L_16000ft	L_25000ft
2CF650	LAmx	A	10 000,0	99,2	91,9	86,7	81,0	72,1	63,0	56,7	49,6	41,6	33,1
2CF650	LAmx	A	25 000,0	105,3	98,3	93,4	88,0	79,5	70,5	64,3	57,4	49,7	41,5
2CF650	LAmx	D	25 000,0	105,3	98,3	93,4	88,0	79,5	70,5	64,3	57,4	49,7	41,5
2CF650	LAmx	D	40 000,0	109,1	102,3	97,6	92,5	84,3	75,4	69,3	62,6	55,1	47,2
2CF650	SEL	A	10 000,0	99,9	95,0	91,4	87,5	81,3	74,6	69,7	64,2	57,7	50,7
2CF650	SEL	A	25 000,0	103,7	99,3	96,1	92,7	87,1	80,6	75,8	70,5	64,3	57,5
2CF650	SEL	D	25 000,0	103,7	99,3	96,1	92,7	87,1	80,6	75,8	70,5	64,3	57,5
2CF650	SEL	D	40 000,0	106,8	102,9	100,1	97,1	92,0	85,8	81,0	75,9	69,9	63,4
2CF680	LAmx	A	7 000,0	96,3	89,8	85,2	80,2	71,9	63,2	56,9	50,8	44,1	37,7
2CF680	LAmx	A	12 000,0	97,5	90,9	86,3	81,3	73,0	64,4	58,3	52,3	45,8	39,6
2CF680	LAmx	D	17 000,0	98,2	91,5	87,0	82,1	74,2	65,8	59,7	53,6	46,9	40,4
2CF680	LAmx	D	25 000,0	98,5	92,6	88,3	83,7	76,4	68,0	62,0	55,6	48,7	41,8
2CF680	LAmx	D	33 000,0	101,5	95,8	91,7	87,3	80,2	71,8	65,8	59,4	52,5	45,5
2CF680	LAmx	D	41 000,0	104,4	99,0	95,2	91,0	84,1	75,8	69,7	63,2	56,0	48,8
2CF680	SEL	A	7 000,0	98,1	93,9	90,8	87,4	81,4	75,0	70,3	65,7	60,6	55,7
2CF680	SEL	A	12 000,0	99,3	95,0	91,9	88,5	82,5	76,2	71,7	67,2	62,3	57,6
2CF680	SEL	D	17 000,0	100,0	95,6	92,6	89,3	83,7	77,6	73,1	68,5	63,4	58,4
2CF680	SEL	D	25 000,0	100,3	96,7	93,9	90,9	85,9	79,8	75,4	70,5	65,2	59,8
2CF680	SEL	D	33 000,0	103,3	99,9	97,3	94,5	89,7	83,6	79,2	74,3	69,0	63,5

NPD_ID	Noise metric	Op type	Power setting (the 'Power Parameter' field in the 'Aircraft' table specifies the power setting type and unit)	L_200ft	L_400ft	L_630ft	L_1000ft	L_2000ft	L_4000ft	L_6300ft	L_10000ft	L_16000ft	L_25000ft
2CF680	SEL	D	41 000,0	106,2	103,1	100,8	98,2	93,6	87,6	83,1	78,1	72,5	66,8
2CF68D	LAmx	A	10 020,0	97,7	91,0	85,8	81,1	73,0	64,5	58,5	51,7	44,8	38,3
2CF68D	LAmx	A	23 190,0	103,3	96,5	91,5	86,5	77,5	68,3	61,7	54,6	47,5	40,4
2CF68D	LAmx	D	25 940,0	101,9	94,6	89,8	85,0	77,5	68,9	62,6	55,3	47,5	37,2
2CF68D	LAmx	D	39 180,0	104,2	97,6	93,1	89,0	81,7	73,4	66,8	60,1	52,2	42,2
2CF68D	LAmx	D	51 530,0	108,4	102,1	97,8	93,5	86,7	78,9	72,8	66,3	58,7	49,2
2CF68D	LAmx	D	55 500,0	111,4	105,1	100,8	96,5	88,7	82,4	76,3	70,3	62,7	54,0
2CF68D	SEL	A	10 020,0	99,5	95,1	91,4	88,3	82,5	76,3	71,9	66,6	61,3	56,3
2CF68D	SEL	A	23 190,0	105,1	100,6	97,1	93,7	87,0	80,1	75,1	69,5	64,0	58,4
2CF68D	SEL	D	25 940,0	103,7	98,7	95,4	92,2	87,0	80,7	76,0	70,2	64,0	55,2
2CF68D	SEL	D	39 180,0	106,0	101,7	98,7	96,2	91,2	85,2	80,2	75,0	68,7	60,2
2CF68D	SEL	D	51 530,0	110,2	106,2	103,4	100,7	96,2	90,7	86,2	81,2	75,2	67,2
2CF68D	SEL	D	55 500,0	113,2	109,2	106,4	103,7	98,2	94,2	89,7	85,2	79,2	72,0
2J155D	LAmx	A	500,0	87,0	79,3	74,0	68,2	59,0	49,2	42,4	35,2	27,6	20,0
2J155D	LAmx	A	1 000,0	92,9	85,4	80,2	74,6	65,6	56,0	49,4	42,4	35,0	27,6
2J155D	LAmx	D	1 500,0	98,3	90,9	85,7	80,1	71,2	61,7	55,1	48,1	40,7	33,4
2J155D	LAmx	D	2 400,0	103,2	97,1	92,5	87,5	79,2	70,0	63,4	56,3	48,7	41,1
2J155D	LAmx	D	2 800,0	107,7	101,4	96,9	91,8	83,5	74,2	67,7	60,6	53,0	45,4
2J155D	SEL	A	500,0	87,3	81,9	78,1	73,8	66,9	59,3	54,0	48,3	42,3	36,2
2J155D	SEL	A	1 000,0	93,3	88,1	84,4	80,3	73,6	66,3	61,1	55,6	49,7	43,8

NPD_ID	Noise metric	Op type	Power setting (the 'Power Parameter' field in the 'Aircraft' table specifies the power setting type and unit)	L_200ft	L_400ft	L_630ft	L_1000ft	L_2000ft	L_4000ft	L_6300ft	L_10000ft	L_16000ft	L_25000ft
2/J155D	SEL	D	1 500,0	99,5	94,3	90,6	86,5	79,9	72,6	67,5	62,0	56,1	50,3
2/J155D	SEL	D	2 400,0	106,2	102,4	99,3	95,8	89,8	82,8	77,8	72,2	66,1	59,9
2/J155D	SEL	D	2 800,0	109,9	106,0	102,9	99,4	93,3	86,4	81,3	75,7	69,6	63,4
2/JT8D	LAmix	A	3 000,0	102,6	94,6	88,6	82,3	73,8	64,5	58,0	51,0	42,8	34,4
2/JT8D	LAmix	A	6 000,0	105,4	97,9	91,5	85,8	77,2	68,5	61,9	55,1	47,1	38,5
2/JT8D	LAmix	D	8 000,0	108,6	100,7	95,6	89,9	81,8	73,2	66,5	59,9	52,0	43,8
2/JT8D	LAmix	D	10 000,0	111,6	104,3	99,5	94,6	86,3	77,7	71,8	64,9	57,2	48,9
2/JT8D	LAmix	D	12 000,0	115,9	108,9	104,3	99,4	91,1	82,8	76,8	70,1	62,8	54,6
2/JT8D	LAmix	D	14 000,0	120,8	113,4	109,4	104,5	96,4	88,2	82,3	75,8	68,6	60,9
2/JT8D	SEL	A	3 000,0	102,3	97,2	92,9	88,5	82,8	75,6	70,9	65,4	58,8	51,8
2/JT8D	SEL	A	6 000,0	106,1	100,5	96,7	93,0	87,2	80,9	76,1	70,7	64,1	56,9
2/JT8D	SEL	D	8 000,0	108,8	103,9	100,5	96,8	91,5	85,7	80,5	75,1	68,9	62,0
2/JT8D	SEL	D	10 000,0	111,4	107,2	104,3	101,1	95,7	89,5	85,0	79,8	73,5	66,7
2/JT8D	SEL	D	12 000,0	115,1	111,1	108,4	105,5	100,2	94,3	89,9	85,0	78,8	72,1
2/JT8D	SEL	D	14 000,0	119,8	115,9	113,3	110,5	105,4	99,7	95,3	90,3	84,5	78,4
2/JT8D2	LAmix	A	4 000,0	89,8	82,7	78,0	73,2	65,6	57,3	51,1	44,5	37,7	31,3
2/JT8D2	LAmix	A	4 667,0	90,8	83,6	79,0	74,2	66,6	58,2	52,0	45,4	38,6	32,2
2/JT8D2	LAmix	A	5 333,0	91,8	84,6	79,9	75,1	67,5	59,1	52,9	46,3	39,4	33,0
2/JT8D2	LAmix	A	6 000,0	92,9	85,6	80,9	76,1	68,4	60,0	53,8	47,1	40,3	33,9
2/JT8D2	LAmix	D	9 000,0	100,6	93,9	89,5	84,8	77,3	69,0	62,9	56,1	49,2	42,5

NPD_ID	Noise metric	Op type	Power setting (the 'Power Parameter' field in the 'Aircraft' table specifies the power setting type and unit)	L_200ft	L_400ft	L_630ft	L_1000ft	L_2000ft	L_4000ft	L_6300ft	L_10000ft	L_16000ft	L_25000ft
2JT8D2	LAmx	D	11 000,0	103,0	96,3	91,9	87,2	79,6	71,2	65,0	58,2	51,2	44,4
2JT8D2	LAmx	D	13 000,0	105,4	98,7	94,2	89,5	81,8	73,3	67,1	60,2	53,1	46,3
2JT8D2	LAmx	D	15 000,0	107,8	101,1	96,6	91,8	84,1	75,5	69,2	62,2	55,1	48,2
2JT8D2	LAmx	D	17 000,0	110,2	103,5	99,0	94,2	86,4	77,6	71,3	64,2	57,0	50,1
2JT8D2	LAmx	D	19 000,0	112,6	105,9	101,4	96,5	88,6	79,8	73,4	66,2	59,0	52,0
2JT8D2	SEL	A	4 000,0	91,5	87,5	84,7	81,9	77,1	71,6	67,2	62,4	57,5	52,9
2JT8D2	SEL	A	4 667,0	92,6	88,5	85,8	82,9	78,1	72,6	68,2	63,4	58,5	53,8
2JT8D2	SEL	A	5 333,0	93,7	89,6	86,8	83,9	79,1	73,6	69,2	64,4	59,4	54,8
2JT8D2	SEL	A	6 000,0	94,7	90,6	87,8	84,9	80,1	74,6	70,2	65,4	60,4	55,7
2JT8D2	SEL	D	9 000,0	100,1	96,3	93,7	91,0	86,3	80,8	76,6	71,6	66,5	61,7
2JT8D2	SEL	D	11 000,0	102,4	98,7	96,1	93,3	88,6	83,0	78,7	73,7	68,7	63,8
2JT8D2	SEL	D	13 000,0	104,8	101,0	98,5	95,6	90,9	85,2	80,9	75,9	70,8	65,9
2JT8D2	SEL	D	15 000,0	107,1	103,4	100,8	98,0	93,1	87,4	83,1	78,0	72,9	68,0
2JT8D2	SEL	D	17 000,0	109,5	105,7	103,2	100,3	95,4	89,6	85,2	80,2	75,0	70,1
2JT8D2	SEL	D	19 000,0	111,8	108,1	105,5	102,7	97,7	91,8	87,4	82,3	77,2	72,2
2JT8DH	LAmx	A	3 000,0	88,6	83,0	76,9	71,2	62,7	54,1	48,0	41,2	33,4	25,2
2JT8DH	LAmx	A	6 000,0	93,9	88,7	84,5	79,9	72,5	64,0	57,8	50,8	42,9	34,3
2JT8DH	LAmx	D	8 000,0	101,1	94,5	90,0	85,2	77,5	68,8	62,5	55,4	47,3	38,7
2JT8DH	LAmx	D	10 000,0	103,5	96,9	92,5	87,7	79,9	71,2	64,8	57,6	49,6	41,2
2JT8DH	LAmx	D	12 000,0	108,0	101,4	97,0	92,2	84,5	75,8	69,4	62,4	54,4	45,9

NPD_ID	Noise metric	Op type	Power setting (the 'Power Parameter' field in the 'Aircraft' table specifies the power setting type and unit)	L_200ft	L_400ft	L_630ft	L_1000ft	L_2000ft	L_4000ft	L_6300ft	L_10000ft	L_16000ft	L_25000ft
2JT8DH	LAmaz	D	14 000,0	110,7	104,2	99,8	95,1	87,5	79,0	72,8	65,9	58,2	50,0
2JT8DH	SEL	A	3 000,0	92,6	88,5	85,0	81,2	75,5	69,0	64,1	58,5	51,9	44,9
2JT8DH	SEL	A	6 000,0	97,9	93,6	90,8	87,9	83,0	76,7	71,7	65,9	59,2	51,8
2JT8DH	SEL	D	8 000,0	99,5	95,8	93,2	90,3	85,4	79,0	73,8	67,9	61,1	53,6
2JT8DH	SEL	D	10 000,0	103,6	99,9	97,3	94,4	89,5	83,0	77,8	71,8	65,0	57,7
2JT8DH	SEL	D	12 000,0	107,2	103,5	100,9	98,0	93,1	86,7	81,5	75,6	68,9	61,5
2JT8DH	SEL	D	14 000,0	110,8	107,2	104,6	101,8	97,0	90,6	85,6	79,9	73,4	66,4
2JT8DL	LAmaz	A	3 000,0	92,7	85,7	80,8	75,8	67,8	59,0	52,6	45,4	37,2	28,7
2JT8DL	LAmaz	A	6 000,0	96,7	89,9	85,3	80,4	72,4	63,6	57,2	50,0	41,8	33,2
2JT8DL	LAmaz	D	8 000,0	102,0	95,2	90,7	85,8	77,8	69,0	62,6	55,5	47,3	38,7
2JT8DL	LAmaz	D	10 000,0	105,7	98,5	93,9	89,0	81,0	72,2	65,8	58,6	50,6	42,0
2JT8DL	LAmaz	D	12 000,0	109,3	102,5	98,0	93,2	85,3	76,5	70,0	62,9	54,9	46,4
2JT8DL	LAmaz	D	14 000,0	112,5	105,8	101,3	96,4	88,5	79,5	72,9	65,7	57,6	49,1
2JT8DL	SEL	A	3 000,0	94,7	90,2	87,0	83,7	78,4	71,7	66,5	60,4	53,5	46,1
2JT8DL	SEL	A	6 000,0	97,9	94,0	91,2	88,2	83,0	76,5	71,2	65,2	58,3	50,8
2JT8DL	SEL	D	8 000,0	101,2	97,3	94,5	91,5	86,3	79,7	74,5	68,5	61,6	54,1
2JT8DL	SEL	D	10 000,0	104,6	101,3	98,4	95,3	90,1	83,6	78,3	72,4	65,5	58,1
2JT8DL	SEL	D	12 000,0	108,1	104,7	101,9	99,0	94,0	87,4	82,1	76,2	69,4	62,1
2JT8DL	SEL	D	14 000,0	111,7	108,0	105,3	102,4	97,3	90,6	85,3	79,2	72,3	65,0
2JT8DN	LAmaz	A	3 000,0	90,6	84,2	79,7	74,9	67,3	59,2	53,6	47,7	41,5	35,4

NPD_ID	Noise metric	Op type	Power setting (the 'Power Parameter' field in the 'Aircraft' table specifies the power setting type and unit)	L_200ft	L_400ft	L_630ft	L_1000ft	L_2000ft	L_4000ft	L_6300ft	L_10000ft	L_16000ft	L_25000ft
2JT8DN	LAmx	A	5 000,0	95,8	89,3	84,8	80,0	72,4	64,3	58,8	52,9	46,6	40,5
2JT8DN	LAmx	D	6 000,0	96,8	90,8	86,5	81,8	74,1	65,8	59,9	53,7	47,0	40,4
2JT8DN	LAmx	D	8 000,0	101,2	95,2	90,9	86,1	78,5	70,2	64,4	58,2	51,6	45,0
2JT8DN	LAmx	D	10 000,0	105,1	99,1	94,7	90,0	82,3	73,8	67,9	61,6	54,8	48,0
2JT8DN	LAmx	D	12 000,0	108,5	102,5	98,1	93,3	85,5	77,0	71,0	64,6	57,8	51,0
2JT8DN	LAmx	D	14 000,0	111,4	105,4	101,0	96,3	88,5	80,1	74,1	67,8	60,9	54,2
2JT8DN	LAmx	D	16 000,0	113,8	107,8	103,4	98,7	90,9	82,5	76,5	70,1	63,3	56,6
2JT8DN	SEL	A	3 000,0	94,0	90,4	87,5	84,2	78,4	71,7	66,7	61,3	55,3	49,3
2JT8DN	SEL	A	5 000,0	98,5	94,9	92,1	88,8	83,0	76,3	71,4	66,0	60,0	53,9
2JT8DN	SEL	D	6 000,0	98,6	94,8	92,0	88,8	83,4	77,4	73,0	68,3	63,1	57,9
2JT8DN	SEL	D	8 000,0	102,7	99,0	96,1	92,9	87,6	81,5	77,2	72,5	67,4	62,3
2JT8DN	SEL	D	10 000,0	106,6	102,9	100,0	96,8	91,3	85,1	80,7	75,9	70,6	65,3
2JT8DN	SEL	D	12 000,0	110,2	106,4	103,5	100,2	94,7	88,4	83,9	79,0	73,7	68,3
2JT8DN	SEL	D	14 000,0	113,1	109,5	106,7	103,5	98,0	91,8	87,3	82,4	77,0	71,6
2JT8DN	SEL	D	16 000,0	115,9	112,3	109,5	106,3	100,8	94,6	90,1	85,2	79,8	74,4
2JT8DQ	LAmx	A	3 000,0	94,9	88,2	83,6	78,6	70,8	62,3	56,1	49,2	41,3	32,8
2JT8DQ	LAmx	A	6 000,0	99,1	92,4	87,8	82,8	75,0	66,5	60,3	53,4	45,5	37,0
2JT8DQ	LAmx	D	8 000,0	104,1	97,4	92,7	87,8	80,0	71,6	65,5	58,6	50,9	42,6
2JT8DQ	LAmx	D	10 000,0	109,2	102,5	98,4	92,8	85,2	76,8	70,8	64,1	56,5	48,5
2JT8DQ	LAmx	D	12 000,0	114,6	107,9	103,3	98,2	90,5	82,3	76,4	69,7	62,4	54,6

NPD_ID	Noise metric	Op type	Power setting (the 'Power Parameter' field in the 'Aircraft' table specifies the power setting type and unit)	L_200ft	L_400ft	L_630ft	L_1000ft	L_2000ft	L_4000ft	L_6300ft	L_10000ft	L_16000ft	L_25000ft
2JT8DQ	LAmx	D	14 000,0	120,1	113,4	108,8	104,0	96,1	87,9	82,1	75,6	68,4	60,9
2JT8DQ	SEL	A	3 000,0	94,6	90,8	87,9	84,8	79,8	73,4	69,0	63,6	57,2	50,2
2JT8DQ	SEL	A	6 000,0	99,8	96,0	93,1	90,0	85,0	78,9	74,2	68,8	62,4	55,4
2JT8DQ	SEL	D	8 000,0	104,3	100,6	97,7	94,7	89,7	83,7	79,1	73,8	67,6	60,8
2JT8DQ	SEL	D	10 000,0	109,0	105,2	102,5	99,5	94,6	88,6	84,1	79,0	72,9	66,3
2JT8DQ	SEL	D	12 000,0	113,8	110,1	107,4	104,5	99,6	93,8	89,3	84,2	78,4	72,1
2JT8DQ	SEL	D	14 000,0	119,1	115,4	112,8	110,0	105,1	99,4	95,0	90,1	84,4	78,4
2JT8DW	LAmx	A	3 000,0	102,6	94,6	88,6	82,3	73,8	64,5	58,0	51,0	42,8	34,4
2JT8DW	LAmx	A	6 000,0	105,4	97,9	91,5	85,8	77,2	68,5	61,9	55,1	47,1	38,5
2JT8DW	LAmx	D	8 000,0	108,6	100,7	95,6	89,9	81,8	73,2	66,5	59,9	52,0	43,8
2JT8DW	LAmx	D	10 000,0	111,6	104,3	99,5	94,6	86,3	77,7	71,8	64,9	57,2	48,9
2JT8DW	LAmx	D	12 000,0	115,9	108,9	104,3	99,4	91,1	82,8	76,8	70,1	62,8	54,6
2JT8DW	LAmx	D	14 000,0	120,8	113,4	109,4	104,5	96,4	88,2	82,3	75,8	68,6	60,9
2JT8DW	SEL	A	3 000,0	102,3	97,2	92,9	88,5	82,8	75,6	70,9	65,4	58,8	51,8
2JT8DW	SEL	A	6 000,0	106,1	100,5	96,7	93,0	87,2	80,9	76,1	70,7	64,1	56,9
2JT8DW	SEL	D	8 000,0	108,8	103,9	100,5	96,8	91,5	85,7	80,5	75,1	68,9	62,0
2JT8DW	SEL	D	10 000,0	111,4	107,2	104,3	101,1	95,7	89,5	85,0	79,8	73,5	66,7
2JT8DW	SEL	D	12 000,0	115,1	111,1	108,4	105,5	100,2	94,3	89,9	85,0	78,8	72,1
2JT8DW	SEL	D	14 000,0	119,8	115,9	113,3	110,5	105,4	99,7	95,3	90,3	84,5	78,4
2JT8QW	LAmx	A	3 000,0	94,9	88,2	83,6	78,6	70,8	62,3	56,1	49,2	41,3	32,8

NPD_ID	Noise metric	Op type	Power setting (the 'Power Parameter' field in the 'Aircraft' table specifies the power setting type and unit)	L_200ft	L_400ft	L_630ft	L_1000ft	L_2000ft	L_4000ft	L_6300ft	L_10000ft	L_16000ft	L_25000ft
2JT8QW	LAmx	A	6 000,0	99,1	92,4	87,8	82,8	75,0	66,5	60,3	53,4	45,5	37,0
2JT8QW	LAmx	D	8 000,0	104,1	97,4	92,7	87,8	80,0	71,6	65,5	58,6	50,9	42,6
2JT8QW	LAmx	D	10 000,0	109,2	102,5	98,4	92,8	85,2	76,8	70,8	64,1	56,5	48,5
2JT8QW	LAmx	D	12 000,0	114,6	107,9	103,3	98,2	90,5	82,3	76,4	69,7	62,4	54,6
2JT8QW	LAmx	D	14 000,0	120,1	113,4	108,8	104,0	96,1	87,9	82,1	75,6	68,4	60,9
2JT8QW	SEL	A	3 000,0	94,6	90,8	87,9	84,8	79,8	73,4	69,0	63,6	57,2	50,2
2JT8QW	SEL	A	6 000,0	99,8	96,0	93,1	90,0	85,0	78,9	74,2	68,8	62,4	55,4
2JT8QW	SEL	D	8 000,0	104,3	100,6	97,7	94,7	89,7	83,7	79,1	73,8	67,6	60,8
2JT8QW	SEL	D	10 000,0	109,0	105,2	102,5	99,5	94,6	88,6	84,1	79,0	72,9	66,3
2JT8QW	SEL	D	12 000,0	113,8	110,1	107,4	104,5	99,6	93,8	89,3	84,2	78,4	72,1
2JT8QW	SEL	D	14 000,0	119,1	115,4	112,8	110,0	105,1	99,4	95,0	90,1	84,4	78,4
2PW535	LAmx	A	500,0	89,5	81,8	76,3	70,3	60,6	50,0	42,6	34,6	26,2	17,7
2PW535	LAmx	A	700,0	89,6	82,2	76,9	71,1	61,6	51,2	43,9	36,1	28,7	19,5
2PW535	LAmx	D	1 200,0	96,1	87,5	81,6	75,4	65,6	55,3	48,3	40,9	33,2	25,6
2PW535	LAmx	D	1 600,0	99,2	89,9	83,7	77,2	67,2	57,0	50,2	43,1	35,8	28,8
2PW535	LAmx	D	2 000,0	100,7	92,2	86,4	80,3	70,9	61,1	54,4	47,4	40,2	33,1
2PW535	LAmx	D	3 000,0	103,5	96,4	91,5	86,1	77,3	67,9	61,3	54,3	46,8	39,4
2PW535	SEL	A	500,0	89,4	84,8	81,3	77,4	70,8	63,2	57,8	51,9	45,6	39,1
2PW535	SEL	A	700,0	89,3	85,1	81,8	78,1	71,7	64,5	59,3	53,5	47,3	41,0
2PW535	SEL	D	1 200,0	90,8	87,1	84,1	80,7	74,7	67,8	62,8	57,2	51,1	44,9

NPD_ID	Noise metric	Op type	Power setting (the 'Power Parameter' field in the 'Aircraft' table specifies the power setting type and unit)	L_200ft	L_400ft	L_630ft	L_1000ft	L_2000ft	L_4000ft	L_6300ft	L_10000ft	L_16000ft	L_25000ft
2PW535	SEL	D	1 600,0	92,6	89,0	86,2	82,9	77,2	70,6	65,8	60,5	54,7	48,8
2PW535	SEL	D	2 000,0	96,0	92,3	89,4	86,1	80,4	73,9	69,2	64,0	58,3	52,6
2PW535	SEL	D	3 000,0	102,3	98,9	96,2	93,1	87,7	81,5	77,0	72,0	66,6	61,1
2R2800	LAmx	A	30,0	92,6	86,1	81,7	77,0	69,5	61,3	55,5	49,6	43,4	36,6
2R2800	LAmx	A	100,0	103,5	97,2	92,9	88,4	81,3	73,6	68,0	61,9	55,3	47,9
2R2800	LAmx	D	30,0	92,6	86,1	81,7	77,0	69,5	61,3	55,5	49,6	43,4	36,6
2R2800	LAmx	D	100,0	103,5	97,2	92,9	88,4	81,3	73,6	68,0	61,9	55,3	47,9
2R2800	SEL	A	30,0	96,9	92,7	89,7	86,5	81,3	75,3	71,0	66,6	61,9	56,6
2R2800	SEL	A	100,0	107,5	103,0	99,9	96,6	91,3	85,4	81,0	76,2	70,7	64,5
2R2800	SEL	D	30,0	96,9	92,7	89,7	86,5	81,3	75,3	71,0	66,6	61,9	56,6
2R2800	SEL	D	100,0	107,5	103,0	99,9	96,6	91,3	85,4	81,0	76,2	70,7	64,5
3JT8D	LAmx	A	3 000,0	104,6	96,6	90,6	84,3	75,8	66,5	60,0	53,0	44,8	36,4
3JT8D	LAmx	A	6 000,0	107,4	98,9	93,5	87,8	79,2	70,5	63,9	57,1	49,1	40,5
3JT8D	LAmx	D	8 000,0	110,6	102,7	97,6	91,9	83,8	75,2	68,5	61,9	54,0	45,8
3JT8D	LAmx	D	10 000,0	113,6	106,3	101,5	96,6	88,3	79,7	73,8	66,9	59,2	50,9
3JT8D	LAmx	D	12 000,0	117,9	110,9	106,3	101,4	93,1	84,8	78,8	72,1	64,8	56,6
3JT8D	LAmx	D	14 000,0	122,8	115,4	111,4	106,5	98,4	90,2	84,3	77,8	70,6	62,8
3JT8D	SEL	A	3 000,0	104,3	99,2	94,9	90,5	84,8	77,6	72,9	67,4	60,8	53,8
3JT8D	SEL	A	6 000,0	108,1	102,5	98,7	95,0	89,2	82,9	78,1	72,7	66,1	58,9
3JT8D	SEL	D	8 000,0	110,8	105,9	102,5	98,8	93,5	87,7	82,5	77,1	70,9	64,0

NPD_ID	Noise metric	Op type	Power setting (the 'Power Parameter' field in the 'Aircraft' table specifies the power setting type and unit)	L_200ft	L_400ft	L_630ft	L_1000ft	L_2000ft	L_4000ft	L_6300ft	L_10000ft	L_16000ft	L_25000ft
3/T8D	SEL	D	10 000,0	113,4	109,2	106,3	103,1	97,7	91,5	87,0	81,8	75,5	68,7
3/T8D	SEL	D	12 000,0	117,1	113,1	110,4	107,5	102,2	96,3	91,9	87,0	80,8	74,1
3/T8D	SEL	D	14 000,0	121,8	117,9	115,3	112,5	107,4	101,7	97,3	92,3	86,5	80,4
3/T8DQ	LAmx	A	3 000,0	96,9	90,2	85,6	80,6	72,8	64,3	58,1	51,2	43,3	34,8
3/T8DQ	LAmx	A	6 000,0	101,1	94,4	89,8	84,8	77,0	68,5	62,3	55,4	47,5	39,0
3/T8DQ	LAmx	D	8 000,0	106,1	99,4	94,8	89,8	82,0	73,6	67,5	60,6	52,9	44,6
3/T8DQ	LAmx	D	10 000,0	111,2	104,5	99,9	95,0	87,2	78,8	72,8	66,1	58,5	50,5
3/T8DQ	LAmx	D	12 000,0	116,6	109,9	105,3	100,4	92,5	84,3	78,4	71,7	64,4	56,6
3/T8DQ	LAmx	D	14 000,0	122,1	115,4	110,8	106,0	98,1	89,9	84,1	77,6	70,4	62,9
3/T8DQ	SEL	A	3 000,0	96,6	92,8	89,8	86,8	81,8	75,4	71,0	65,6	59,2	52,2
3/T8DQ	SEL	A	6 000,0	101,8	98,0	95,1	92,0	87,0	80,9	76,2	70,8	64,4	57,4
3/T8DQ	SEL	D	8 000,0	106,3	102,6	99,7	96,7	91,7	85,7	81,1	75,8	69,6	62,8
3/T8DQ	SEL	D	10 000,0	111,0	107,2	104,5	101,5	96,6	90,6	86,1	81,0	74,9	68,3
3/T8DQ	SEL	D	12 000,0	115,8	112,1	109,4	106,5	101,6	95,8	91,3	86,2	80,4	74,1
3/T8DQ	SEL	D	14 000,0	121,1	117,4	114,8	112,0	107,1	101,4	97,0	92,1	86,4	80,4
3/T8E5	LAmx	A	3 000,0	96,4	89,3	84,5	79,3	71,3	62,6	56,1	49,0	41,0	32,0
3/T8E5	LAmx	A	5 000,0	98,0	91,3	86,7	81,8	74,0	65,4	59,1	52,2	44,3	35,6
3/T8E5	LAmx	D	7 000,0	104,7	97,8	93,0	87,8	79,5	70,3	63,4	55,8	47,3	38,0
3/T8E5	LAmx	D	10 000,0	109,2	102,3	97,5	92,4	84,2	75,1	68,4	61,3	53,3	44,7
3/T8E5	LAmx	D	12 000,0	112,1	105,3	100,6	95,6	87,7	79,3	73,2	66,7	59,5	51,5

NPD_ID	Noise metric	Op type	Power setting (the 'Power Parameter' field in the 'Aircraft' table specifies the power setting type and unit)	L_200ft	L_400ft	L_630ft	L_1000ft	L_2000ft	L_4000ft	L_6300ft	L_10000ft	L_16000ft	L_25000ft
3JT8E5	LAmx	D	14 000,0	115,5	108,7	104,1	99,1	91,4	83,1	77,1	70,9	63,9	56,2
3JT8E5	SEL	A	3 000,0	98,2	93,4	90,1	86,5	80,8	74,4	69,5	63,9	57,5	50,0
3JT8E5	SEL	A	5 000,0	99,8	95,4	92,3	89,0	83,5	77,2	72,5	67,1	60,8	53,6
3JT8E5	SEL	D	7 000,0	106,5	101,9	98,6	95,0	89,0	82,1	76,8	70,7	63,8	56,0
3JT8E5	SEL	D	10 000,0	111,0	106,4	103,1	99,6	93,7	86,9	81,8	76,2	69,8	62,7
3JT8E5	SEL	D	12 000,0	113,9	109,4	106,2	102,8	97,2	91,1	86,6	81,6	76,0	69,5
3JT8E5	SEL	D	14 000,0	117,3	112,8	109,7	106,3	100,9	94,9	90,5	85,8	80,4	74,2
3JT8E7	LAmx	A	3 000,0	95,1	88,3	84,0	78,3	70,1	61,1	54,4	47,2	39,2	30,4
3JT8E7	LAmx	A	5 000,0	98,1	91,3	86,5	81,3	73,1	64,1	57,4	50,2	42,2	33,4
3JT8E7	LAmx	D	7 000,0	103,9	97,0	92,2	87,0	78,7	69,5	62,6	55,0	46,5	37,2
3JT8E7	LAmx	D	10 000,0	109,1	102,2	97,4	92,2	83,9	74,7	68,0	60,8	52,9	44,0
3JT8E7	LAmx	D	12 000,0	111,9	105,2	100,4	95,4	87,4	78,6	72,1	65,1	57,0	47,9
3JT8E7	LAmx	D	14 000,0	114,6	107,9	103,2	98,2	90,3	81,7	75,2	68,3	60,5	51,7
3JT8E7	SEL	A	3 000,0	96,9	92,4	89,6	85,5	79,6	72,9	67,8	62,1	55,7	48,4
3JT8E7	SEL	A	5 000,0	99,9	95,4	92,1	88,5	82,6	75,9	70,8	65,1	58,7	51,4
3JT8E7	SEL	D	7 000,0	105,7	101,1	97,8	94,2	88,2	81,3	76,0	69,9	63,0	55,2
3JT8E7	SEL	D	10 000,0	110,9	106,3	103,0	99,4	93,4	86,5	81,4	75,7	69,4	62,0
3JT8E7	SEL	D	12 000,0	113,7	109,3	106,0	102,6	96,9	90,4	85,5	80,0	73,5	65,9
3JT8E7	SEL	D	14 000,0	116,4	112,0	108,8	105,4	99,8	93,5	88,6	83,2	77,0	69,7
4R2800	LAmx	A	30,0	95,6	89,1	84,7	80,0	72,5	64,3	58,5	52,6	46,4	39,6

NPD_ID	Noise metric	Op type	Power setting (the 'Power Parameter' field in the 'Aircraft' table specifies the power setting type and unit)	L_200ft	L_400ft	L_630ft	L_1000ft	L_2000ft	L_4000ft	L_6300ft	L_10000ft	L_16000ft	L_25000ft
4R2800	LAmx	A	100,0	106,5	100,2	95,9	91,4	84,3	76,6	71,0	64,9	58,3	50,9
4R2800	LAmx	D	30,0	95,6	89,1	84,7	80,0	72,5	64,3	58,5	52,6	46,4	39,6
4R2800	LAmx	D	100,0	106,5	100,2	95,9	91,4	84,3	76,6	71,0	64,9	58,3	50,9
4R2800	SEL	A	30,0	99,9	95,7	92,7	89,5	84,3	78,3	74,0	69,6	64,9	59,6
4R2800	SEL	A	100,0	110,5	106,0	102,9	99,6	94,3	88,4	84,0	79,2	73,7	67,5
4R2800	SEL	D	30,0	99,9	95,7	92,7	89,5	84,3	78,3	74,0	69,6	64,9	59,6
4R2800	SEL	D	100,0	110,5	106,0	102,9	99,6	94,3	88,4	84,0	79,2	73,7	67,5
501D13	LAmx	A	30,0	93,0	86,4	81,8	76,9	68,9	59,4	52,0	44,0	36,2	28,6
501D13	LAmx	A	100,0	96,8	90,3	85,9	81,3	74,3	67,0	62,1	57,0	51,5	45,4
501D13	LAmx	D	30,0	93,0	86,4	81,8	76,9	68,9	59,4	52,0	44,0	36,2	28,6
501D13	LAmx	D	100,0	96,8	90,3	85,9	81,3	74,3	67,0	62,1	57,0	51,5	45,4
501D13	SEL	A	30,0	95,0	90,7	87,6	84,2	78,4	71,2	65,3	58,8	52,5	46,4
501D13	SEL	A	100,0	97,1	92,8	89,9	86,8	82,0	77,0	73,6	69,9	66,0	61,4
501D13	SEL	D	30,0	95,0	90,7	87,6	84,2	78,4	71,2	65,3	58,8	52,5	46,4
501D13	SEL	D	100,0	97,1	92,8	89,9	86,8	82,0	77,0	73,6	69,9	66,0	61,4
A310	LAmx	A	3 000,0	92,2	86,2	81,7	77,0	69,2	60,4	54,0	47,1	39,4	31,4
A310	LAmx	A	12 000,0	95,5	89,4	84,4	79,2	70,8	61,9	55,6	48,6	40,8	32,6
A310	LAmx	D	20 000,0	101,6	93,8	88,6	82,7	73,0	63,1	56,1	48,3	40,1	31,8
A310	LAmx	D	30 000,0	103,4	95,3	89,9	84,2	75,4	66,1	59,6	52,5	44,5	36,1
A310	LAmx	D	40 000,0	104,4	96,9	91,9	86,6	78,3	69,2	62,7	55,7	48,0	39,7

NPD_ID	Noise metric	Op type	Power setting (the 'Power Parameter' field in the 'Aircraft' table specifies the power setting type and unit)	L_200ft	L_400ft	L_630ft	L_1000ft	L_2000ft	L_4000ft	L_6300ft	L_10000ft	L_16000ft	L_25000ft
A310	LAmx	D	50 000,0	108,8	101,6	96,7	91,5	83,0	73,7	67,7	61,0	53,3	44,8
A310	SEL	A	3 000,0	97,5	93,3	90,1	87,0	81,6	75,7	71,2	66,4	60,0	51,9
A310	SEL	A	12 000,0	98,9	94,5	91,3	88,0	82,6	76,4	71,8	66,4	60,5	52,3
A310	SEL	D	20 000,0	102,7	98,3	94,5	90,5	83,8	76,5	71,6	66,1	59,5	52,7
A310	SEL	D	30 000,0	103,7	99,2	95,8	92,3	86,7	80,4	75,8	70,4	64,3	57,6
A310	SEL	D	40 000,0	104,5	100,4	97,6	94,4	89,2	83,4	79,0	73,9	68,0	61,4
A310	SEL	D	50 000,0	108,0	103,9	101,2	98,2	93,3	87,8	83,6	78,6	72,9	66,4
AE3007	LAmx	A	2 000,0	85,5	78,7	74,2	69,3	61,5	52,7	46,4	39,3	31,2	22,7
AE3007	LAmx	A	3 000,0	90,4	83,5	78,7	73,5	65,5	56,8	50,6	43,6	35,4	26,9
AE3007	LAmx	D	4 000,0	90,8	84,3	79,8	75,1	67,5	58,9	52,6	45,5	37,4	28,6
AE3007	LAmx	D	5 000,0	93,0	86,6	82,1	77,4	69,8	61,2	54,9	47,8	39,8	31,3
AE3007	LAmx	D	6 000,0	96,0	89,5	85,0	80,3	72,6	64,0	57,7	50,6	42,5	34,0
AE3007	SEL	A	2 000,0	89,8	85,6	82,7	79,5	74,1	67,8	63,2	57,7	51,4	44,3
AE3007	SEL	A	3 000,0	92,7	88,6	85,6	82,3	77,0	70,9	66,3	61,0	54,8	47,9
AE3007	SEL	D	4 000,0	91,7	88,1	85,4	82,5	77,7	72,0	67,6	62,4	56,1	49,1
AE3007	SEL	D	5 000,0	93,6	90,0	87,4	84,6	79,8	74,2	69,9	64,8	58,7	51,9
AE3007	SEL	D	6 000,0	96,7	93,0	90,3	87,5	82,8	77,2	72,8	67,7	61,6	54,9
AE300C	LAmx	A	1 100,0	88,6	80,4	74,8	69,0	59,9	50,4	44,0	37,0	30,4	23,6
AE300C	LAmx	A	1 400,0	88,6	80,4	74,8	69,0	59,9	50,4	44,0	37,0	30,4	23,6
AE300C	LAmx	A	1 900,0	88,6	80,7	75,3	69,5	60,6	51,3	44,9	38,1	31,3	24,5

NPD_ID	Noise metric	Op type	Power setting (the 'Power Parameter' field in the 'Aircraft' table specifies the power setting type and unit)	L_200ft	L_400ft	L_630ft	L_1000ft	L_2000ft	L_4000ft	L_6300ft	L_10000ft	L_16000ft	L_25000ft
AE300C	LAmx	D	3 500,0	90,6	83,5	78,4	73,1	64,4	55,2	48,7	42,0	34,7	27,5
AE300C	LAmx	D	4 500,0	92,7	85,7	80,7	75,5	67,1	58,1	51,9	45,2	38,3	31,4
AE300C	LAmx	D	5 500,0	94,7	88,0	83,3	78,2	69,9	60,9	54,7	47,9	40,9	33,9
AE300C	SEL	A	1 100,0	91,1	86,1	82,6	78,7	72,5	65,8	61,1	56,0	50,8	45,5
AE300C	SEL	A	1 400,0	91,1	86,1	82,6	78,7	72,5	65,8	61,1	56,0	50,8	45,5
AE300C	SEL	A	1 900,0	92,5	87,1	83,3	79,4	73,1	66,4	61,8	56,7	51,8	46,8
AE300C	SEL	D	3 500,0	92,9	88,2	84,7	80,8	74,4	67,2	62,1	56,7	50,6	44,6
AE300C	SEL	D	4 500,0	95,2	90,4	87,0	83,2	77,1	70,4	65,7	60,6	55,2	49,8
AE300C	SEL	D	5 500,0	96,6	92,4	89,3	85,7	79,7	72,9	68,0	62,7	57,0	51,2
AL502L	LAmx	A	1 900,0	88,4	81,5	76,6	71,3	62,7	53,2	46,4	39,1	31,4	23,2
AL502L	LAmx	A	5 000,0	98,0	91,5	86,9	82,2	74,4	65,8	59,4	52,6	45,1	36,8
AL502L	LAmx	D	1 900,0	88,4	81,5	76,6	71,3	62,7	53,2	46,4	39,1	31,4	23,2
AL502L	LAmx	D	5 000,0	98,0	91,5	86,9	82,2	74,4	65,8	59,4	52,6	45,1	36,8
AL502L	SEL	A	1 900,0	90,2	85,5	82,1	78,3	72,0	64,7	59,4	53,6	47,4	40,7
AL502L	SEL	A	5 000,0	101,1	96,8	93,8	90,5	85,0	78,6	73,8	68,4	62,5	55,6
AL502L	SEL	D	1 900,0	90,2	85,5	82,1	78,3	72,0	64,7	59,4	53,6	47,4	40,7
AL502L	SEL	D	5 000,0	101,1	96,8	93,8	90,5	85,0	78,6	73,8	68,4	62,5	55,6
AL502R	LAmx	A	1 600,0	91,2	84,5	79,7	74,5	66,3	57,0	50,1	42,3	33,7	25,0
AL502R	LAmx	A	5 200,0	101,6	94,8	89,8	84,6	76,3	67,5	61,2	54,3	47,0	39,7
AL502R	LAmx	D	1 600,0	91,2	84,5	79,7	74,5	66,3	57,0	50,1	42,3	33,7	25,0

NPD_ID	Noise metric	Op type	Power setting (the 'Power Parameter' field in the 'Aircraft' table specifies the power setting type and unit)	L_200ft	L_400ft	L_630ft	L_1000ft	L_2000ft	L_4000ft	L_6300ft	L_10000ft	L_16000ft	L_25000ft
AL502R	LAmx	D	5 200.0	101,6	94,8	89,8	84,6	76,3	67,5	61,2	54,3	47,0	39,7
AL502R	SEL	A	1 600.0	92,9	89,0	86,0	82,7	77,3	70,4	65,0	58,7	51,6	44,3
AL502R	SEL	A	5 200.0	102,3	98,4	95,4	92,1	86,8	80,4	75,6	70,3	64,4	58,7
AL502R	SEL	D	1 600.0	92,9	89,0	86,0	82,7	77,3	70,4	65,0	58,7	51,6	44,3
AL502R	SEL	D	5 200.0	102,3	98,4	95,4	92,1	86,8	80,4	75,6	70,3	64,4	58,7
BR710	LAmx	A	1 830.0	87,7	80,6	75,8	70,7	62,6	54,0	47,8	41,1	33,7	26,0
BR710	LAmx	A	2 000.0	87,9	80,7	75,9	70,7	62,7	54,0	47,9	41,2	33,7	25,9
BR710	LAmx	A	3 000.0	88,9	81,7	76,7	71,5	63,4	54,8	48,6	41,7	34,1	26,1
BR710	LAmx	A	4 000.0	90,1	82,9	77,9	72,7	64,6	55,9	49,7	42,8	35,1	27,1
BR710	LAmx	A	5 000.0	92,5	85,3	80,4	75,0	66,6	57,6	51,1	44,0	35,9	27,5
BR710	LAmx	A	6 000.0	94,7	87,7	82,7	77,3	68,8	59,8	53,3	46,0	37,9	29,3
BR710	LAmx	A	7 000.0	96,7	89,7	84,7	79,3	70,9	61,8	55,2	47,9	39,7	31,1
BR710	LAmx	A	8 000.0	98,4	91,5	86,5	81,1	72,7	63,6	57,1	49,8	41,6	32,9
BR710	LAmx	A	9 000.0	99,9	93,0	88,0	82,7	74,4	65,3	58,8	51,5	43,3	34,7
BR710	LAmx	A	10 000.0	101,0	94,1	89,3	84,0	75,8	66,8	60,4	53,2	45,0	36,5
BR710	LAmx	A	11 000.0	101,6	95,0	90,2	85,1	77,0	68,2	61,8	54,7	46,7	38,3
BR710	LAmx	A	12 000.0	102,6	95,6	90,9	85,9	78,0	69,3	63,1	56,1	48,3	40,1
BR710	LAmx	A	12 900.0	102,9	95,9	91,3	86,4	78,7	70,3	64,1	57,3	49,7	41,7
BR710	LAmx	D	4 000.0	90,0	82,7	77,7	72,5	64,1	55,2	48,9	41,8	33,9	25,7
BR710	LAmx	D	5 000.0	92,5	85,3	80,4	75,0	66,6	57,6	51,1	44,0	35,9	27,5

NPD_ID	Noise metric	Op type	Power setting (the 'Power Parameter' field in the 'Aircraft' table specifies the power setting type and unit)	L_200ft	L_400ft	L_630ft	L_1000ft	L_2000ft	L_4000ft	L_6300ft	L_10000ft	L_16000ft	L_25000ft
BR710	LAmx	D	6 000,0	94,7	87,7	82,7	77,3	68,8	59,8	53,3	46,0	37,9	29,3
BR710	LAmx	D	7 000,0	96,7	89,7	84,7	79,3	70,9	61,8	55,2	47,9	39,7	31,1
BR710	LAmx	D	8 000,0	98,4	91,5	86,5	81,1	72,7	63,6	57,1	49,8	41,6	32,9
BR710	LAmx	D	9 000,0	99,9	93,0	88,0	82,7	74,4	65,3	58,8	51,5	43,3	34,7
BR710	LAmx	D	10 000,0	101,0	94,1	89,3	84,0	75,8	66,8	60,4	53,2	45,0	36,5
BR710	LAmx	D	11 000,0	101,6	95,0	90,2	85,1	77,0	68,2	61,8	54,7	46,7	38,3
BR710	LAmx	D	12 000,0	102,6	95,6	90,9	85,9	78,0	69,3	63,1	56,1	48,3	40,1
BR710	LAmx	D	12 900,0	102,9	95,9	91,3	86,4	78,7	70,3	64,1	57,3	49,7	41,7
BR710	SEL	A	1 830,0	90,3	85,8	82,8	79,6	74,3	68,3	63,8	58,7	53,0	46,8
BR710	SEL	A	2 000,0	90,3	85,9	82,9	79,7	74,4	68,4	63,9	58,8	53,0	46,8
BR710	SEL	A	3 000,0	91,0	86,6	83,6	80,3	75,0	69,1	64,6	59,5	53,6	47,2
BR710	SEL	A	4 000,0	92,2	87,6	84,5	81,2	76,0	70,1	65,7	60,6	54,7	48,2
BR710	SEL	A	5 000,0	92,7	88,5	85,6	82,3	76,9	70,8	66,3	61,1	54,9	48,1
BR710	SEL	A	6 000,0	94,7	90,5	87,6	84,2	78,8	72,7	68,1	62,9	56,7	49,9
BR710	SEL	A	7 000,0	96,5	92,4	89,4	86,1	80,6	74,5	69,9	64,7	58,5	51,7
BR710	SEL	A	8 000,0	98,1	94,1	91,1	87,8	82,3	76,2	71,7	66,4	60,3	53,5
BR710	SEL	A	9 000,0	99,6	95,6	92,6	89,4	83,9	77,9	73,4	68,1	62,0	55,3
BR710	SEL	A	10 000,0	100,9	96,9	94,0	90,8	85,5	79,5	75,0	69,8	63,8	57,1
BR710	SEL	A	11 000,0	102,1	98,1	95,3	92,2	86,9	81,0	76,6	71,5	65,5	58,9
BR710	SEL	A	12 000,0	103,1	99,1	96,4	93,4	88,3	82,5	78,1	73,1	67,2	60,7

NPD_ID	Noise metric	Op type	Power setting (the 'Power Parameter' field in the 'Aircraft' table specifies the power setting type and unit)	L_200ft	L_400ft	L_630ft	L_1000ft	L_2000ft	L_4000ft	L_6300ft	L_10000ft	L_16000ft	L_25000ft
BR710	SEL	A	12 900,0	103,8	99,9	97,3	94,4	89,5	83,8	79,5	74,5	68,7	62,3
BR710	SEL	D	4 000,0	90,5	86,4	83,5	80,2	74,9	68,9	64,4	59,2	53,0	46,2
BR710	SEL	D	5 000,0	92,7	88,5	85,6	82,3	76,9	70,8	66,3	61,1	54,9	48,1
BR710	SEL	D	6 000,0	94,7	90,5	87,6	84,2	78,8	72,7	68,1	62,9	56,7	49,9
BR710	SEL	D	7 000,0	96,5	92,4	89,4	86,1	80,6	74,5	69,9	64,7	58,5	51,7
BR710	SEL	D	8 000,0	98,1	94,1	91,1	87,8	82,3	76,2	71,7	66,4	60,3	53,5
BR710	SEL	D	9 000,0	99,6	95,6	92,6	89,4	83,9	77,9	73,4	68,1	62,0	55,3
BR710	SEL	D	10 000,0	100,9	96,9	94,0	90,8	85,5	79,5	75,0	69,8	63,8	57,1
BR710	SEL	D	11 000,0	102,1	98,1	95,3	92,2	86,9	81,0	76,6	71,5	65,5	58,9
BR710	SEL	D	12 000,0	103,1	99,1	96,4	93,4	88,3	82,5	78,1	73,1	67,2	60,7
BR710	SEL	D	12 900,0	103,8	99,9	97,3	94,4	89,5	83,8	79,5	74,5	68,7	62,3
BR715	LAmx	A	4 250,0	89,2	81,6	76,8	71,6	63,4	54,6	48,3	41,6	34,7	28,2
BR715	LAmx	A	5 000,0	89,6	82,4	77,5	72,4	64,2	55,4	49,1	42,3	35,5	28,9
BR715	LAmx	A	5 750,0	89,9	83,0	78,2	73,0	64,9	56,1	49,7	43,0	36,1	29,6
BR715	LAmx	A	9 875,0	93,8	87,0	82,4	77,6	69,8	61,4	55,3	48,6	41,8	35,3
BR715	LAmx	D	11 000,0	95,7	88,9	84,3	79,5	71,7	63,1	57,0	50,2	43,4	36,9
BR715	LAmx	D	13 000,0	98,6	91,9	87,3	82,5	74,6	66,0	59,8	52,9	46,0	39,4
BR715	LAmx	D	15 000,0	101,2	94,5	90,0	85,1	77,2	68,5	62,2	55,3	48,3	41,6
BR715	LAmx	D	17 000,0	103,5	97,0	92,4	87,5	79,6	70,7	64,4	57,4	50,4	43,7
BR715	LAmx	D	19 000,0	106,4	99,9	95,3	90,4	82,4	73,4	67,0	60,0	52,9	46,2

NPD_ID	Noise metric	Op type	Power setting (the 'Power Parameter' field in the 'Aircraft' table specifies the power setting type and unit)	L_200ft	L_400ft	L_630ft	L_1000ft	L_2000ft	L_4000ft	L_6300ft	L_10000ft	L_20000ft	L_40000ft	L_63000ft	L_100000ft	L_160000ft	L_250000ft
BR715	LAmx	D	19 750,0	107,5	101,0	96,5	91,6	83,5	74,5	68,1	61,1	53,9	47,2				
BR715	SEL	A	4 250,0	91,9	87,1	84,1	80,7	75,2	69,0	64,4	59,4	54,2	49,4				
BR715	SEL	A	5 000,0	92,2	88,0	84,9	81,5	76,1	69,9	65,3	60,3	55,2	50,3				
BR715	SEL	A	5 750,0	92,5	88,6	85,6	82,2	76,8	70,6	66,0	61,0	55,9	51,1				
BR715	SEL	A	9 875,0	95,7	91,5	88,7	85,6	80,5	74,8	70,5	65,6	60,7	56,0				
BR715	SEL	D	11 000,0	97,3	93,1	90,3	87,2	82,1	76,4	72,1	67,2	62,3	57,6				
BR715	SEL	D	13 000,0	99,8	95,7	92,9	89,8	84,7	78,9	74,7	69,8	64,9	60,2				
BR715	SEL	D	15 000,0	102,1	98,0	95,2	92,1	87,0	81,2	77,0	72,1	67,2	62,5				
BR715	SEL	D	17 000,0	104,1	100,1	97,3	94,2	89,1	83,3	79,0	74,2	69,2	64,6				
BR715	SEL	D	19 000,0	106,6	102,7	99,8	96,7	91,6	85,8	81,5	76,7	71,8	67,2				
BR715	SEL	D	19 750,0	107,6	103,7	100,8	97,7	92,6	86,8	82,5	77,7	72,8	68,2				
CF34	LAmx	A	2 000,0	87,3	80,7	76,0	71,1	63,0	54,1	47,6	40,6	33,0	24,6				
CF34	LAmx	A	3 000,0	90,6	83,8	79,0	73,9	65,6	56,5	49,8	42,7	34,9	26,5				
CF34	LAmx	D	4 000,0	93,1	86,3	81,5	76,5	68,4	59,6	53,1	46,0	38,2	29,6				
CF34	LAmx	D	5 000,0	95,0	88,2	83,5	78,6	70,6	61,9	55,6	48,7	40,9	32,3				
CF34	LAmx	D	6 000,0	97,2	90,9	86,1	81,2	73,2	64,5	58,2	51,5	43,5	34,9				
CF34	SEL	A	2 000,0	90,9	86,7	83,3	79,9	74,1	67,4	62,4	56,9	50,7	43,9				
CF34	SEL	A	3 000,0	94,3	89,8	86,5	82,9	76,9	70,0	64,8	59,2	52,9	46,0				
CF34	SEL	D	4 000,0	96,3	91,8	88,5	85,0	79,1	72,5	67,5	61,9	55,6	48,6				
CF34	SEL	D	5 000,0	97,7	93,2	90,0	86,5	80,8	74,3	69,5	64,1	57,9	50,7				

NPD_ID	Noise metric	Op type	Power setting (the 'Power Parameter' field in the 'Aircraft' table specifies the power setting type and unit)	L_200ft	L_400ft	L_630ft	L_1000ft	L_2000ft	L_4000ft	L_6300ft	L_10000ft	L_16000ft	L_25000ft
CF34	SEL	D	6 000,0	99,7	95,2	92,0	88,5	82,8	76,3	71,5	66,1	59,9	52,7
CF3410E	LAmx	A	3 000,0	90,1	83,6	79,1	74,4	66,9	58,6	52,6	45,7	37,9	29,5
CF3410E	LAmx	A	5 000,0	91,9	85,3	80,7	75,9	68,3	59,9	53,9	47,2	39,6	31,4
CF3410E	LAmx	D	8 000,0	94,9	88,5	84,0	79,3	71,9	63,7	57,7	51,0	43,3	34,8
CF3410E	LAmx	D	10 000,0	97,6	91,1	86,6	81,9	74,3	66,0	60,2	53,4	45,6	37,1
CF3410E	LAmx	D	15 000,0	103,3	96,8	92,3	87,5	79,8	71,3	65,1	58,3	50,4	42,0
CF3410E	SEL	A	3 000,0	92,5	88,8	86,1	83,2	78,4	72,7	68,3	63,3	57,2	50,5
CF3410E	SEL	A	5 000,0	93,9	90,1	87,4	84,4	79,5	73,9	69,6	64,7	58,9	52,4
CF3410E	SEL	D	8 000,0	95,9	92,2	89,6	86,7	81,8	76,3	72,1	67,1	61,2	54,5
CF3410E	SEL	D	10 000,0	98,6	94,9	92,1	89,2	84,4	78,8	74,6	69,9	63,9	57,2
CF3410E	SEL	D	15 000,0	103,8	100,2	97,5	94,6	89,8	84,1	79,9	74,9	69,1	62,6
CF348C5	LAmx	A	2 500,0	89,7	83,1	78,6	73,8	66,2	57,6	51,3	44,1	36,0	27,3
CF348C5	LAmx	A	7 250,0	91,3	84,7	80,2	75,4	67,6	58,9	52,6	45,5	37,6	29,2
CF348C5	LAmx	D	7 250,0	94,5	87,9	83,5	78,7	71,0	62,3	56,0	48,8	40,5	31,7
CF348C5	LAmx	D	16 250,0	103,6	97,1	92,6	87,9	80,2	71,6	65,3	58,3	50,3	42,0
CF348C5	SEL	A	2 500,0	93,1	89,2	86,4	83,3	78,2	72,0	67,1	61,5	54,9	47,7
CF348C5	SEL	A	7 250,0	95,2	91,0	88,1	85,0	79,8	73,6	68,8	63,2	56,8	49,9
CF348C5	SEL	D	7 250,0	96,4	92,3	89,5	86,5	81,5	75,3	70,4	64,7	58,0	50,6
CF348C5	SEL	D	16 250,0	104,7	100,9	98,2	95,3	90,4	84,4	79,6	74,0	67,6	60,7
CF348E	LAmx	A	3 000,0	91,1	84,4	79,8	74,8	66,8	57,8	51,3	44,0	35,9	27,5

NPD_ID	Noise metric	Op type	Power setting (the 'Power Parameter' field in the 'Aircraft' table specifies the power setting type and unit)	L_200ft	L_400ft	L_630ft	L_1000ft	L_2000ft	L_4000ft	L_6300ft	L_10000ft	L_20000ft	L_40000ft	L_63000ft	L_100000ft	L_160000ft	L_250000ft
CF348E	LAmx	A	4 000,0	92,0	85,3	80,7	75,8	67,8	59,0	52,5	45,5	37,6	29,6				
CF348E	LAmx	D	7 000,0	95,5	88,9	84,3	79,4	71,5	62,8	56,5	49,5	41,6	33,5				
CF348E	LAmx	D	9 000,0	99,3	92,7	88,2	83,4	75,5	66,8	60,6	53,7	46,0	38,0				
CF348E	LAmx	D	11 000,0	103,3	96,6	92,0	87,1	79,2	70,3	64,0	57,2	49,6	41,8				
CF348E	SEL	A	3 000,0	93,5	89,6	86,7	83,5	78,2	72,0	67,2	61,6	55,3	48,6				
CF348E	SEL	A	4 000,0	94,7	90,7	87,9	84,7	79,4	73,3	68,7	63,3	57,2	50,7				
CF348E	SEL	D	7 000,0	97,3	93,2	90,5	87,4	82,3	76,2	71,7	66,4	60,4	54,0				
CF348E	SEL	D	9 000,0	100,3	96,5	93,9	91,0	86,0	80,3	75,9	70,9	65,0	58,6				
CF348E	SEL	D	11 000,0	103,4	99,7	97,1	94,2	89,4	83,8	79,5	74,6	68,9	62,5				
CF565C	LAmx	A	3 000,0	93,3	86,6	82,1	77,3	69,7	61,5	55,6	48,9	41,5	33,6				
CF565C	LAmx	A	5 000,0	94,2	87,3	82,5	77,6	69,9	61,6	55,6	49,0	41,5	33,6				
CF565C	LAmx	D	12 500,0	98,9	89,4	82,8	76,4	67,3	57,8	51,3	44,2	36,3	27,7				
CF565C	LAmx	D	20 000,0	103,4	95,3	89,8	83,9	75,3	66,2	59,9	53,0	45,0	36,3				
CF565C	LAmx	D	27 500,0	106,9	99,4	94,4	89,3	81,0	71,9	65,4	58,3	50,2	41,5				
CF565C	SEL	A	3 000,0	98,7	92,8	89,9	86,8	81,7	76,0	71,7	66,6	60,8	54,3				
CF565C	SEL	A	5 000,0	99,0	93,3	90,1	86,9	81,9	76,1	71,8	66,7	60,9	54,3				
CF565C	SEL	D	12 500,0	98,8	92,6	88,7	84,8	78,6	71,9	67,1	61,6	55,4	48,5				
CF565C	SEL	D	20 000,0	105,3	99,9	96,4	92,9	87,3	81,0	76,4	70,9	64,7	57,8				
CF565C	SEL	D	27 500,0	108,0	103,5	100,5	97,4	92,1	86,2	81,7	76,2	70,7	64,6				
CF567B	LAmx	A	3 000,0	93,0	85,9	81,1	76,1	68,0	59,2	52,5	45,6	37,5	29,3				

NPD_ID	Noise metric	Op type	Power setting (the 'Power Parameter' field in the 'Aircraft' table specifies the power setting type and unit)	L_200ft	L_400ft	L_630ft	L_1000ft	L_2000ft	L_4000ft	L_6300ft	L_10000ft	L_16000ft	L_25000ft
CF567B	LAmix	A	4 000,0	93,6	86,5	81,7	76,6	68,7	59,9	53,4	46,6	37,8	29,7
CF567B	LAmix	A	5 000,0	94,1	87,0	82,2	77,2	69,2	60,5	54,1	47,4	39,0	31,1
CF567B	LAmix	A	6 000,0	94,6	87,5	82,7	77,6	69,7	61,1	54,7	48,1	40,4	32,9
CF567B	LAmix	A	7 000,0	95,0	87,9	83,0	78,0	70,1	61,5	55,2	48,7	41,8	34,5
CF567B	LAmix	D	10 000,0	95,2	87,9	83,6	78,8	71,3	63,0	57,3	50,4	44,2	36,9
CF567B	LAmix	D	13 000,0	98,1	91,0	86,7	82,0	74,5	66,3	60,7	53,9	46,9	39,6
CF567B	LAmix	D	16 000,0	100,5	93,7	89,3	84,6	77,3	69,2	63,5	56,8	49,4	42,1
CF567B	LAmix	D	19 000,0	102,7	96,0	91,7	87,1	79,7	71,7	66,1	59,5	52,2	44,9
CF567B	LAmix	D	23 500,0	107,2	100,9	96,5	91,9	84,7	76,8	71,4	64,6	57,7	50,4
CF567B	SEL	A	3 000,0	95,5	91,3	88,2	84,9	79,5	73,3	68,3	63,2	55,9	49,6
CF567B	SEL	A	4 000,0	96,2	91,9	88,8	85,6	80,2	74,1	69,4	64,3	56,8	50,7
CF567B	SEL	A	5 000,0	96,7	92,5	89,4	86,1	80,8	74,8	70,1	65,2	58,0	52,4
CF567B	SEL	A	6 000,0	97,2	93,0	89,9	86,7	81,4	75,5	70,9	66,0	59,4	54,3
CF567B	SEL	A	7 000,0	97,7	93,4	90,4	87,1	81,9	76,0	71,5	66,7	60,8	55,6
CF567B	SEL	D	10 000,0	96,3	92,1	89,4	86,3	81,4	75,9	72,0	67,0	61,3	51,9
CF567B	SEL	D	13 000,0	99,2	95,2	92,4	89,4	84,7	79,3	75,4	70,5	64,5	56,1
CF567B	SEL	D	16 000,0	101,7	97,6	95,0	92,1	87,4	82,1	78,3	73,5	67,3	60,0
CF567B	SEL	D	19 000,0	103,9	99,9	97,3	94,5	89,9	84,7	81,0	76,2	70,3	63,7
CF567B	SEL	D	23 500,0	108,4	104,5	102,0	99,3	95,0	89,9	86,4	81,5	75,5	69,5
CF66D	LAmix	A	8 000,0	99,2	92,0	86,6	81,0	72,1	63,0	56,5	49,1	40,8	32,5

NPD_ID	Noise metric	Op type	Power setting (the 'Power Parameter' field in the 'Aircraft' table specifies the power setting type and unit)	L_200ft	L_400ft	L_630ft	L_1000ft	L_2000ft	L_4000ft	L_6300ft	L_10000ft	L_16000ft	L_25000ft
CF66D	LAmx	A	14 000,0	102,1	95,0	89,9	84,5	76,0	67,0	60,6	53,3	45,1	37,1
CF66D	LAmx	D	20 000,0	104,5	97,6	92,7	87,5	79,3	70,4	64,1	56,9	48,9	41,0
CF66D	LAmx	D	28 000,0	106,2	99,4	94,6	89,5	81,5	72,6	66,4	59,3	51,3	43,6
CF66D	LAmx	D	36 000,0	107,8	101,1	96,5	91,5	83,7	74,9	68,7	61,7	53,8	46,2
CF66D	SEL	A	8 000,0	100,7	95,5	91,7	87,5	81,1	74,0	68,8	63,0	56,3	49,7
CF66D	SEL	A	14 000,0	104,4	99,5	95,9	92,0	85,9	79,0	73,9	68,3	61,7	55,2
CF66D	SEL	D	20 000,0	106,8	102,2	98,7	95,0	89,0	82,3	77,3	71,8	65,4	58,9
CF66D	SEL	D	28 000,0	109,3	104,8	101,4	98,0	92,2	85,6	80,7	75,3	69,0	62,6
CF66D	SEL	D	36 000,0	110,9	106,6	103,3	100,0	94,3	87,8	83,0	77,6	71,4	65,1
CF680C	LAmx	A	5 500,0	94,4	87,4	82,8	78,0	70,4	61,9	55,7	48,8	40,9	31,7
CF680C	LAmx	A	7 000,0	95,3	88,1	83,5	78,5	70,7	62,1	55,8	49,0	40,9	31,4
CF680C	LAmx	A	12 000,0	95,9	88,8	84,1	79,1	71,3	62,7	56,4	49,6	41,7	32,5
CF680C	LAmx	A	15 000,0	98,9	91,2	86,2	80,7	72,3	63,4	57,0	50,1	42,0	32,1
CF680C	LAmx	D	17 000,0	101,6	93,6	87,8	81,4	71,6	62,2	55,8	48,8	40,6	30,5
CF680C	LAmx	D	21 000,0	100,8	93,1	87,6	81,7	72,6	63,6	57,4	50,7	42,7	33,0
CF680C	LAmx	D	25 000,0	100,6	93,1	87,8	82,3	73,8	65,0	59,0	52,4	44,7	35,2
CF680C	LAmx	D	33 000,0	101,3	94,2	89,3	84,2	76,3	67,9	62,1	55,7	48,2	39,2
CF680C	LAmx	D	41 000,0	103,1	96,3	91,5	86,7	79,1	70,9	65,1	58,9	51,5	42,6
CF680C	LAmx	D	54 000,0	109,7	103,2	98,8	94,0	86,4	78,2	72,5	66,2	59,0	50,4
CF680C	SEL	A	5 500,0	95,9	93,2	90,4	87,2	82,1	76,2	71,6	66,4	60,4	53,5

NPD_ID	Noise metric	Op type	Power setting (the 'Power Parameter' field in the 'Aircraft' table specifies the power setting type and unit)	L_200ft	L_400ft	L_630ft	L_1000ft	L_2000ft	L_4000ft	L_6300ft	L_10000ft	L_16000ft	L_25000ft
CF680C	SEL	A	7 000,0	96,6	93,7	90,7	87,5	82,2	76,2	71,5	66,4	60,4	53,4
CF680C	SEL	A	12 000,0	98,0	94,9	91,8	88,5	83,0	76,9	72,2	67,1	61,0	53,9
CF680C	SEL	A	15 000,0	99,2	97,1	93,8	90,1	84,2	77,6	72,9	67,7	61,6	54,5
CF680C	SEL	D	17 000,0	104,5	99,3	95,3	90,7	83,1	75,4	70,6	65,4	59,2	51,4
CF680C	SEL	D	21 000,0	103,1	98,4	94,7	90,5	83,7	76,8	72,3	67,3	61,4	53,9
CF680C	SEL	D	25 000,0	102,5	98,0	94,6	90,8	84,6	78,2	73,8	69,1	63,4	56,2
CF680C	SEL	D	33 000,0	102,6	98,5	95,5	92,1	86,7	80,9	76,9	72,3	66,9	60,1
CF680C	SEL	D	41 000,0	104,0	100,1	97,3	94,2	89,2	83,8	79,9	75,4	70,1	63,5
CF680C	SEL	D	54 000,0	109,8	106,1	103,6	100,8	96,1	90,8	86,9	82,6	77,5	71,2
CF680E	LAmx	A	6 000,0	93,8	86,6	82,0	77,2	69,6	61,4	55,4	48,7	41,1	33,0
CF680E	LAmx	A	12 000,0	96,7	89,2	84,3	79,1	71,0	62,4	56,2	49,2	41,6	33,5
CF680E	LAmx	D	34 000,0	105,5	97,4	92,0	86,3	77,7	68,4	61,8	54,3	46,2	37,4
CF680E	LAmx	D	42 000,0	106,0	98,2	93,2	88,0	79,8	70,7	64,2	56,9	48,8	40,1
CF680E	LAmx	D	52 000,0	107,5	100,1	95,2	90,2	82,3	73,8	67,6	60,6	52,7	44,0
CF680E	LAmx	D	62 000,0	111,7	104,4	99,6	94,5	86,6	78,4	72,4	65,6	57,6	48,8
CF680E	SEL	A	6 000,0	99,1	93,5	90,3	87,1	81,9	76,1	71,7	66,6	60,3	53,7
CF680E	SEL	A	12 000,0	100,0	94,8	91,5	88,2	82,8	76,9	72,3	67,1	60,8	54,2
CF680E	SEL	D	34 000,0	106,7	101,4	98,1	94,5	88,6	82,2	77,6	72,2	65,9	58,9
CF680E	SEL	D	42 000,0	107,2	102,4	99,4	96,0	90,6	84,4	79,9	74,6	68,4	61,5
CF680E	SEL	D	52 000,0	108,4	104,1	101,2	98,2	93,2	87,4	83,0	77,6	71,6	64,8

NPD_ID	Noise metric	Op type	Power setting (the 'Power Parameter' field in the 'Aircraft' table specifies the power setting type and unit)	L_200ft	L_400ft	L_630ft	L_1000ft	L_2000ft	L_4000ft	L_6300ft	L_10000ft	L_16000ft	L_25000ft
CF680E	SEL	D	62 000,0	112,7	108,3	105,4	102,5	97,6	91,9	87,7	82,5	76,5	70,4
CF700	LAmx	A	850,0	98,2	90,6	84,9	78,7	68,7	59,1	52,4	45,3	37,6	29,2
CF700	LAmx	A	1 500,0	100,5	93,5	88,6	83,5	74,6	64,9	57,6	49,7	41,7	33,0
CF700	LAmx	D	2 500,0	101,0	94,0	89,1	84,0	75,9	66,9	60,2	52,8	44,8	36,1
CF700	LAmx	D	3 750,0	108,6	101,4	96,3	91,0	82,4	72,6	65,3	57,2	48,4	38,9
CF700	SEL	A	850,0	100,7	95,3	91,2	86,4	78,7	71,4	66,2	60,5	54,4	47,4
CF700	SEL	A	1 500,0	102,8	97,8	94,1	90,0	83,4	75,9	70,1	63,7	57,2	50,0
CF700	SEL	D	2 500,0	104,2	99,5	96,1	92,5	86,7	79,9	74,7	68,9	62,3	55,1
CF700	SEL	D	3 750,0	111,3	106,4	102,8	99,0	92,6	85,1	79,2	72,7	65,4	57,4
CFM562	LAmx	A	5 000,0	96,4	89,8	85,2	80,4	72,6	64,0	57,5	50,3	42,1	33,4
CFM562	LAmx	A	10 000,0	100,5	94,0	89,2	84,4	76,7	68,7	61,8	54,7	46,5	37,8
CFM562	LAmx	D	10 000,0	100,5	94,0	89,2	84,4	76,7	68,7	61,8	54,7	46,5	37,8
CFM562	LAmx	D	15 500,0	106,1	99,5	94,8	89,9	82,3	73,9	67,8	60,8	52,6	43,9
CFM562	SEL	A	5 000,0	97,9	93,5	90,4	87,1	81,9	75,6	70,7	64,9	58,2	51,0
CFM562	SEL	A	10 000,0	101,5	97,2	94,2	91,0	85,9	79,8	75,0	69,3	62,6	55,4
CFM562	SEL	D	10 000,0	101,5	97,2	94,2	91,0	85,9	79,8	75,0	69,3	62,6	55,4
CFM562	SEL	D	15 500,0	106,5	102,5	99,6	96,5	91,6	85,7	81,0	75,5	68,9	61,6
CFM563	LAmx	A	2 500,0	93,4	85,7	80,8	75,6	67,4	58,2	51,5	44,0	36,5	29,1
CFM563	LAmx	A	3 500,0	94,5	86,7	81,8	76,5	68,2	59,1	52,5	45,1	37,6	30,4
CFM563	LAmx	A	4 500,0	95,8	88,0	83,0	77,7	69,5	60,4	53,9	46,6	39,2	32,1

NPD_ID	Noise metric	Op type	Power setting (the 'Power Parameter' field in the 'Aircraft' table specifies the power setting type and unit)	L_200ft	L_400ft	L_630ft	L_1000ft	L_2000ft	L_4000ft	L_6300ft	L_10000ft	L_16000ft	L_25000ft
CFM563	LAmx	A	5 500,0	97,2	89,3	84,4	79,1	71,0	62,0	55,6	48,3	41,0	33,9
CFM563	LAmx	D	6 500,0	95,8	89,1	84,5	79,6	71,7	63,2	56,9	49,8	42,5	35,7
CFM563	LAmx	D	9 000,0	97,0	90,3	85,8	80,9	73,2	64,8	58,6	51,6	44,5	37,8
CFM563	LAmx	D	11 500,0	98,6	92,0	87,4	82,7	75,0	66,7	60,6	53,8	46,8	40,2
CFM563	LAmx	D	14 000,0	100,4	93,8	89,3	84,5	77,0	68,8	62,8	56,0	49,2	42,7
CFM563	LAmx	D	16 500,0	102,2	95,7	91,2	86,5	79,0	70,9	65,0	58,4	51,6	45,3
CFM563	LAmx	D	19 000,0	104,4	97,9	93,5	88,9	81,5	73,5	67,6	61,1	54,5	48,3
CFM563	SEL	A	2 500,0	94,7	90,2	87,1	83,7	78,1	71,5	66,7	61,1	55,4	49,8
CFM563	SEL	A	3 500,0	96,3	91,5	88,3	84,7	79,0	72,5	67,7	62,2	56,6	51,2
CFM563	SEL	A	4 500,0	97,6	92,8	89,5	85,8	80,1	73,7	69,0	63,6	58,1	52,8
CFM563	SEL	A	5 500,0	98,8	93,9	90,6	86,9	81,4	75,0	70,4	65,1	59,7	54,4
CFM563	SEL	D	6 500,0	96,4	92,3	89,3	86,1	80,9	75,2	70,8	65,6	60,3	55,4
CFM563	SEL	D	9 000,0	97,9	93,7	90,7	87,5	82,4	76,8	72,5	67,5	62,5	57,7
CFM563	SEL	D	11 500,0	99,5	95,4	92,5	89,3	84,3	78,9	74,7	69,9	64,9	60,3
CFM563	SEL	D	14 000,0	101,1	97,2	94,4	91,3	86,5	81,2	77,1	72,3	67,5	63,0
CFM563	SEL	D	16 500,0	102,8	99,0	96,3	93,5	88,8	83,6	79,6	74,9	70,2	65,8
CFM563	SEL	D	19 000,0	104,7	101,2	98,7	96,0	91,5	86,4	82,5	78,0	73,4	69,1
CFM565	LAmx	A	2 700,0	91,7	84,4	79,7	74,8	67,0	58,5	52,2	45,3	37,5	29,5
CFM565	LAmx	A	6 000,0	93,8	86,1	80,9	75,6	67,4	58,7	52,4	45,5	37,7	29,7
CFM565	LAmx	D	12 000,0	100,3	92,0	86,2	80,3	71,1	61,7	55,4	48,6	40,9	33,1

NPD_ID	Noise metric	Op type	Power setting (the 'Power Parameter' field in the 'Aircraft' table specifies the power setting type and unit)	L_200ft	L_400ft	L_630ft	L_1000ft	L_2000ft	L_4000ft	L_6300ft	L_10000ft	L_16000ft	L_25000ft
CFM565	LAmx	D	15 500,0	102,5	94,9	89,5	83,6	74,0	65,0	58,8	52,1	44,7	36,8
CFM565	LAmx	D	19 000,0	104,3	96,6	91,1	85,7	77,2	68,2	62,2	55,5	47,9	40,0
CFM565	LAmx	D	22 500,0	105,9	98,9	94,1	88,9	80,9	72,5	66,1	59,4	51,7	43,3
CFM565	SEL	A	2 700,0	96,6	90,5	87,5	84,2	78,9	72,8	68,2	62,9	56,8	50,3
CFM565	SEL	A	6 000,0	97,4	91,6	88,2	84,8	79,3	73,1	68,5	63,3	57,1	50,6
CFM565	SEL	D	12 000,0	100,9	96,2	92,4	88,3	81,9	75,5	71,1	66,0	60,0	53,8
CFM565	SEL	D	15 500,0	103,6	99,0	95,3	91,5	85,6	79,3	74,9	69,9	64,2	57,9
CFM565	SEL	D	19 000,0	104,7	100,5	97,3	93,9	88,3	82,4	78,1	73,2	67,3	61,0
CFM565	SEL	D	22 500,0	106,5	102,4	99,6	96,4	91,4	85,7	81,5	76,5	70,8	64,3
CJ610	LAmx	A	700,0	98,5	91,9	87,3	82,4	74,3	65,0	58,0	50,1	41,3	31,6
CJ610	LAmx	A	1 800,0	117,1	110,3	105,6	100,5	92,2	82,5	75,1	66,7	57,0	46,0
CJ610	LAmx	D	1 800,0	117,1	110,3	105,6	100,5	92,2	82,5	75,1	66,7	57,0	46,0
CJ610	LAmx	D	2 600,0	122,2	115,0	109,8	104,3	95,3	85,3	77,6	68,9	59,0	47,9
CJ610	SEL	A	700,0	100,8	96,4	93,3	89,9	84,0	77,0	71,5	65,1	57,8	49,6
CJ610	SEL	A	1 800,0	119,3	114,8	111,6	108,0	101,9	94,5	88,6	81,6	73,4	63,9
CJ610	SEL	D	1 800,0	119,3	114,8	111,6	108,0	101,9	94,5	88,6	81,6	73,4	63,9
CJ610	SEL	D	2 600,0	124,7	119,7	116,0	112,0	105,3	97,5	91,3	84,1	75,7	66,1
CT75	LAmx	A	30,0	86,9	80,5	76,1	71,6	64,5	57,0	51,6	45,6	38,6	30,9
CT75	LAmx	A	75,0	88,1	81,7	77,4	73,0	66,0	58,5	53,3	47,6	41,3	34,5
CT75	LAmx	D	75,0	88,1	81,7	77,4	73,0	66,0	58,5	53,3	47,6	41,3	34,5

NPD_ID	Noise metric	Op type	Power setting (the 'Power Parameter' field in the 'Aircraft' table specifies the power setting type and unit)	L_200ft	L_400ft	L_630ft	L_1000ft	L_2000ft	L_4000ft	L_6300ft	L_10000ft	L_16000ft	L_25000ft
CT75	LAmx	D	100,0	95,2	88,9	84,7	80,3	73,4	66,1	60,8	54,8	47,9	40,1
CT75	SEL	A	30,0	87,5	83,4	80,5	77,5	72,7	67,4	63,6	59,1	53,6	47,3
CT75	SEL	A	75,0	89,0	85,1	82,5	79,5	75,1	69,9	66,2	62,0	57,2	51,8
CT75	SEL	D	75,0	89,0	85,1	82,5	79,5	75,1	69,9	66,2	62,0	57,2	51,8
CT75	SEL	D	100,0	97,0	92,8	90,1	87,3	82,9	77,8	74,0	69,5	64,1	57,8
EPW118	LAmx	A	700,0	88,9	82,0	77,1	71,9	63,6	55,2	49,3	42,9	34,7	27,0
EPW118	LAmx	A	1 000,0	88,3	81,5	76,8	71,8	64,0	55,5	49,4	42,4	33,5	25,1
EPW118	LAmx	D	2 000,0	85,8	79,2	74,8	70,2	63,0	55,2	49,6	43,2	35,4	28,1
EPW118	LAmx	D	3 000,0	86,4	79,9	75,6	71,1	64,0	56,6	51,3	45,6	38,7	32,1
EPW118	LAmx	D	3 800,0	92,0	85,7	81,5	77,1	70,4	63,3	58,4	53,0	46,2	39,7
EPW118	SEL	A	700,0	94,5	87,5	82,7	77,5	69,2	60,7	54,9	48,4	40,3	32,6
EPW118	SEL	A	1 000,0	94,9	88,1	83,4	78,4	70,6	62,1	56,0	49,0	40,2	31,7
EPW118	SEL	D	2 000,0	98,4	91,9	87,4	82,8	75,6	67,8	62,2	55,9	48,1	40,7
EPW118	SEL	D	3 000,0	98,7	92,3	87,9	83,4	76,4	68,9	63,7	58,0	51,0	44,5
EPW118	SEL	D	3 800,0	100,9	94,6	90,4	86,0	79,3	72,2	67,3	61,9	55,0	48,6
FJ44-4	LAmx	A	600,0	86,7	79,1	73,8	68,1	59,1	49,4	42,7	35,7	28,2	20,8
FJ44-4	LAmx	A	900,0	89,1	81,8	76,6	70,9	61,7	51,7	44,6	37,1	29,1	21,1
FJ44-4	LAmx	D	1 700,0	96,4	88,4	82,8	76,9	67,6	57,7	50,9	43,7	36,2	28,8
FJ44-4	LAmx	D	2 400,0	98,2	91,8	87,1	81,8	73,2	63,5	56,7	49,3	41,3	33,4
FJ44-4	LAmx	D	3 000,0	101,5	95,2	90,6	85,4	76,8	67,3	60,5	53,1	45,2	37,3

NPD_ID	Noise metric	Op type	Power setting (the 'Power Parameter' field in the 'Aircraft' table specifies the power setting type and unit)	L_200ft	L_400ft	L_630ft	L_1000ft	L_2000ft	L_4000ft	L_6300ft	L_10000ft	L_16000ft	L_25000ft
FJ44-4	LAmx	D	3 300,0	103,8	97,4	92,7	87,5	78,9	69,4	62,7	55,4	47,6	39,8
FJ44-4	SEL	A	600,0	87,3	82,8	79,5	75,9	70,0	63,4	58,8	53,9	48,6	43,3
FJ44-4	SEL	A	900,0	90,4	85,5	82,0	78,1	71,8	64,9	60,0	54,8	49,2	43,6
FJ44-4	SEL	D	1 700,0	94,2	90,0	86,8	83,2	77,2	70,5	65,7	60,6	55,0	49,3
FJ44-4	SEL	D	2 400,0	98,2	94,4	91,5	88,2	82,5	76,0	71,3	66,1	60,5	54,8
FJ44-4	SEL	D	3 000,0	102,0	98,5	95,7	92,5	86,9	80,4	75,7	70,5	64,9	59,1
FJ44-4	SEL	D	3 300,0	104,5	101,0	98,2	95,0	89,5	83,2	78,6	73,5	68,0	62,4
GE90	LAmx	A	12 000,0	94,2	86,8	81,8	76,8	68,9	60,3	54,1	47,5	40,8	34,5
GE90	LAmx	A	17 000,0	95,3	87,9	82,9	77,9	69,9	61,2	55,0	48,3	41,5	35,1
GE90	LAmx	A	22 000,0	96,6	89,0	84,0	78,9	70,7	62,0	55,6	48,9	42,0	35,6
GE90	LAmx	A	27 000,0	97,9	90,0	84,9	79,7	71,4	62,5	56,2	49,4	42,5	36,0
GE90	LAmx	D	31 000,0	97,5	90,7	86,0	80,8	72,8	63,8	57,5	50,4	43,3	36,4
GE90	LAmx	D	41 000,0	98,8	92,0	87,3	82,2	74,2	65,3	59,0	52,1	45,1	38,4
GE90	LAmx	D	51 000,0	100,6	93,8	89,2	84,1	76,2	67,3	61,1	54,3	47,5	40,9
GE90	LAmx	D	61 000,0	102,8	96,0	91,4	86,4	78,5	69,7	63,6	56,9	50,1	43,5
GE90	LAmx	D	71 000,0	105,0	98,3	93,7	88,7	80,8	72,1	66,1	59,4	52,7	46,3
GE90	LAmx	D	81 000,0	109,0	102,4	97,8	92,9	85,2	76,7	70,8	64,4	58,0	52,0
GE90	SEL	A	12 000,0	97,7	92,8	89,5	86,3	80,9	74,9	70,4	65,5	60,5	55,8
GE90	SEL	A	17 000,0	98,6	93,9	90,6	87,2	81,7	75,7	71,1	66,1	61,1	56,4
GE90	SEL	A	22 000,0	99,8	94,9	91,5	88,1	82,5	76,3	71,7	66,7	61,6	56,9

NPD_ID	Noise metric	Op type	Power setting (the 'Power Parameter' field in the 'Aircraft' table specifies the power setting type and unit)	L_200ft	L_400ft	L_630ft	L_1000ft	L_2000ft	L_4000ft	L_6300ft	L_10000ft	L_16000ft	L_25000ft
GE90	SEL	A	27 000,0	101,0	95,9	92,4	88,8	83,2	76,9	72,3	67,2	62,1	57,3
GE90	SEL	D	31 000,0	100,0	95,8	92,7	89,2	83,5	76,9	72,2	66,9	61,4	56,2
GE90	SEL	D	41 000,0	101,2	97,1	94,2	90,7	85,1	78,5	73,9	68,7	63,4	58,4
GE90	SEL	D	51 000,0	102,7	98,8	95,9	92,5	87,0	80,6	76,1	71,1	66,0	61,1
GE90	SEL	D	61 000,0	104,4	100,6	97,7	94,5	89,2	82,9	78,6	73,7	68,7	64,0
GE90	SEL	D	71 000,0	106,1	102,3	99,5	96,4	91,3	85,3	81,1	76,3	71,5	66,9
GE90	SEL	D	81 000,0	109,1	105,4	102,7	99,7	95,0	89,6	85,7	81,3	77,0	73,0
GE9015	LAmx	A	12 000,0	96,1	88,9	84,3	79,4	71,6	63,2	57,1	50,5	43,8	37,5
GE9015	LAmx	A	17 333,0	96,5	89,3	84,6	79,7	71,9	63,4	57,3	50,7	43,9	37,6
GE9015	LAmx	A	22 667,0	97,2	90,0	85,3	80,3	72,5	63,9	57,6	51,0	44,1	37,7
GE9015	LAmx	A	28 000,0	98,2	90,9	86,1	81,1	73,2	64,5	58,1	51,4	44,4	37,9
GE9015	LAmx	D	39 000,0	100,4	93,2	88,4	83,4	75,3	66,5	60,1	52,9	45,6	38,6
GE9015	LAmx	D	50 600,0	101,8	94,7	89,9	84,8	76,6	67,7	61,5	54,5	47,4	40,6
GE9015	LAmx	D	62 200,0	103,5	96,6	91,8	86,7	78,5	69,6	63,3	56,4	49,4	42,7
GE9015	LAmx	D	73 800,0	105,5	98,6	93,8	88,7	80,5	71,7	65,4	58,6	51,7	45,0
GE9015	LAmx	D	85 400,0	108,5	101,7	96,9	91,9	83,8	75,1	68,9	62,1	55,3	48,8
GE9015	LAmx	D	97 000,0	114,5	107,6	103,0	98,1	90,4	81,8	75,7	68,9	61,9	55,4
GE9015	SEL	A	12 000,0	99,5	94,9	91,8	88,7	83,5	77,6	73,1	68,3	63,3	58,6
GE9015	SEL	A	17 333,0	99,9	95,2	92,1	88,9	83,6	77,7	73,2	68,3	63,2	58,5
GE9015	SEL	A	22 667,0	100,5	95,9	92,8	89,5	84,1	78,1	73,5	68,5	63,4	58,6

NPD_ID	Noise metric	Op type	Power setting (the 'Power Parameter' field in the 'Aircraft' table specifies the power setting type and unit)	L_200ft	L_400ft	L_630ft	L_1000ft	L_2000ft	L_4000ft	L_6300ft	L_10000ft	L_16000ft	L_25000ft
GE9015	SEL	A	28 000,0	101,3	96,7	93,5	90,2	84,8	78,7	74,0	68,9	63,7	58,9
GE9015	SEL	D	39 000,0	102,7	97,8	94,4	90,9	85,3	78,9	74,3	68,9	63,5	58,3
GE9015	SEL	D	50 600,0	103,6	98,9	95,7	92,3	86,7	80,4	75,9	70,7	65,5	60,6
GE9015	SEL	D	62 200,0	105,0	100,5	97,4	94,1	88,5	82,3	77,9	72,9	67,8	63,0
GE9015	SEL	D	73 800,0	106,6	102,3	99,2	96,0	90,5	84,4	80,0	75,1	70,1	65,4
GE9015	SEL	D	85 400,0	109,3	105,0	102,1	98,9	93,6	87,7	83,4	78,6	73,7	69,1
GE9015	SEL	D	97 000,0	114,7	110,6	107,7	104,7	99,7	94,1	89,9	85,1	80,2	75,6
GENX67	LAmx	A	7 000,0	99,0	91,8	87,0	82,2	74,4	65,9	59,6	52,8	45,9	39,4
GENX67	LAmx	A	12 000,0	99,6	92,4	87,6	82,8	75,0	66,5	60,2	53,3	46,4	39,9
GENX67	LAmx	A	17 000,0	100,0	92,8	88,0	83,2	75,3	66,7	60,4	53,5	46,5	40,0
GENX67	LAmx	A	22 000,0	100,4	93,2	88,3	83,4	75,4	66,8	60,4	53,5	46,5	39,9
GENX67	LAmx	D	17 000,0	101,0	94,3	89,7	84,9	77,2	68,7	62,5	55,5	48,4	41,5
GENX67	LAmx	D	25 000,0	101,5	94,8	90,2	85,3	77,5	68,8	62,6	55,6	48,4	41,6
GENX67	LAmx	D	33 000,0	102,9	96,2	91,5	86,6	78,7	70,0	63,7	56,6	49,5	42,6
GENX67	LAmx	D	41 000,0	104,8	98,0	93,4	88,5	80,5	71,7	65,4	58,3	51,0	44,1
GENX67	LAmx	D	49 000,0	107,0	100,2	95,5	90,6	82,6	73,8	67,4	60,2	53,0	46,0
GENX67	LAmx	D	57 000,0	110,1	103,4	98,7	93,8	85,8	76,9	70,5	63,2	55,9	49,0
GENX67	SEL	A	7 000,0	101,0	96,8	93,9	90,9	85,7	79,7	75,1	70,0	64,9	60,1
GENX67	SEL	A	12 000,0	101,6	97,4	94,5	91,4	86,2	80,2	75,6	70,5	65,3	60,4
GENX67	SEL	A	17 000,0	102,3	98,0	95,0	91,9	86,6	80,6	75,9	70,7	65,4	60,5

NPD_ID	Noise metric	Op type	Power setting (the 'Power Parameter' field in the 'Aircraft' table specifies the power setting type and unit)	L_200ft	L_400ft	L_630ft	L_1000ft	L_2000ft	L_4000ft	L_6300ft	L_10000ft	L_16000ft	L_25000ft
GENX67	SEL	A	22 000,0	102,8	98,5	95,5	92,3	86,9	80,8	76,1	70,8	65,4	60,4
GENX67	SEL	D	17 000,0	102,0	98,1	95,3	92,4	87,4	81,7	77,3	72,1	66,9	61,8
GENX67	SEL	D	25 000,0	102,6	98,6	95,8	92,8	87,6	81,7	77,3	72,1	66,9	61,8
GENX67	SEL	D	33 000,0	103,9	99,9	97,1	94,0	88,8	82,8	78,4	73,2	68,0	62,9
GENX67	SEL	D	41 000,0	105,5	101,6	98,8	95,7	90,5	84,5	80,1	74,9	69,7	64,7
GENX67	SEL	D	49 000,0	107,4	103,5	100,7	97,7	92,5	86,6	82,2	77,0	71,8	66,8
GENX67	SEL	D	57 000,0	110,1	106,3	103,5	100,6	95,5	89,7	85,3	80,2	75,1	70,2
GP7270	LAmx	A	5 500,0	92,0	86,2	81,9	77,4	69,8	61,4	55,3	48,6	41,2	33,5
GP7270	LAmx	A	7 500,0	92,4	86,4	82,1	77,5	69,9	61,6	55,5	48,8	41,3	33,5
GP7270	LAmx	A	12 000,0	93,4	87,0	82,5	77,9	70,3	61,9	55,8	49,1	41,6	33,7
GP7270	LAmx	A	14 000,0	94,0	87,5	82,9	78,1	70,4	62,0	55,9	49,2	41,7	33,9
GP7270	LAmx	D	40 000,0	99,3	92,8	88,5	83,7	75,9	67,2	60,9	53,9	45,9	37,3
GP7270	LAmx	D	50 000,0	102,0	95,9	91,3	86,5	78,7	70,1	63,8	56,8	48,8	40,2
GP7270	LAmx	D	60 000,0	104,1	98,2	93,8	89,1	81,6	73,0	66,8	59,7	51,7	43,1
GP7270	LAmx	D	80 000,0	111,3	105,6	101,7	97,1	90,0	81,7	75,5	68,2	61,1	52,5
GP7270	SEL	A	5 500,0	96,8	92,6	89,8	86,7	81,6	75,7	71,2	66,2	60,4	54,2
GP7270	SEL	A	7 500,0	97,3	93,0	90,0	86,9	81,8	75,9	71,5	66,4	60,6	54,3
GP7270	SEL	A	12 000,0	98,4	93,9	90,8	87,6	82,4	76,4	72,0	66,9	61,0	54,6
GP7270	SEL	A	14 000,0	99,0	94,3	91,2	88,0	82,7	76,8	72,3	67,2	61,3	54,8
GP7270	SEL	D	40 000,0	102,6	98,2	95,0	91,8	86,5	80,6	76,1	71,0	64,9	58,2

NPD_ID	Noise metric	Op type	Power setting (the 'Power Parameter' field in the 'Aircraft' table specifies the power setting type and unit)	L_200ft	L_400ft	L_630ft	L_1000ft	L_2000ft	L_4000ft	L_6300ft	L_10000ft	L_16000ft	L_25000ft
GP7270	SEL	D	50 000,0	105,6	101,0	97,9	94,8	89,7	83,8	79,5	74,3	68,3	61,6
GP7270	SEL	D	60 000,0	107,7	103,5	100,5	97,4	92,2	86,4	82,0	76,9	70,8	64,1
GP7270	SEL	D	80 000,0	114,8	111,0	108,5	105,6	100,6	94,9	90,6	85,5	79,6	72,7
IO320B	LAmx	A	55,0	79,0	72,6	68,2	63,6	56,4	48,5	43,0	36,8	30,0	22,9
IO320B	LAmx	A	107,0	79,8	73,3	68,9	64,3	56,8	48,3	42,1	35,3	27,9	20,6
IO320B	LAmx	D	201,0	86,6	79,8	75,1	70,0	62,5	54,3	48,3	41,6	34,2	26,7
IO320B	LAmx	D	214,0	89,5	82,6	77,8	72,7	64,6	56,2	50,1	43,4	35,8	28,1
IO320B	LAmx	D	339,0	96,1	89,0	84,0	78,6	70,2	61,5	55,3	48,3	40,5	32,3
IO320B	SEL	A	55,0	82,3	78,4	75,7	72,9	68,2	62,8	58,8	54,3	49,2	44,1
IO320B	SEL	A	107,0	83,5	79,8	77,1	74,2	69,1	63,0	58,5	53,5	48,0	42,8
IO320B	SEL	D	201,0	90,2	85,8	82,8	79,6	74,3	68,3	63,9	58,8	53,0	47,2
IO320B	SEL	D	214,0	93,9	89,0	85,7	82,2	76,6	70,4	65,9	60,7	54,7	48,6
IO320B	SEL	D	339,0	98,8	94,5	91,4	88,1	82,5	76,1	71,4	66,1	60,0	53,5
IO360L	LAmx	A	26,6	71,6	64,2	59,7	55,0	47,7	39,8	34,4	28,5	22,4	16,9
IO360L	LAmx	A	58,2	78,8	72,2	67,7	62,9	55,2	46,7	40,7	34,1	27,0	20,3
IO360L	LAmx	D	59,6	82,7	75,6	71,1	66,4	58,9	50,8	45,0	38,6	31,7	24,5
IO360L	LAmx	D	100,0	84,6	77,8	73,2	68,2	60,4	52,0	46,2	39,9	33,5	25,6
IO360L	SEL	A	26,6	73,0	68,7	65,8	63,0	58,6	53,6	50,0	46,2	42,4	38,8
IO360L	SEL	A	58,2	79,3	75,3	72,7	69,9	65,1	59,6	55,5	51,1	46,3	43,0
IO360L	SEL	D	59,6	83,5	79,8	77,2	74,4	69,7	64,1	59,9	55,3	50,3	45,8

NPD_ID	Noise metric	Op type	Power setting (the 'Power Parameter' field in the 'Aircraft' table specifies the power setting type and unit)	L_200ft	L_400ft	L_630ft	L_1000ft	L_2000ft	L_4000ft	L_6300ft	L_10000ft	L_16000ft	L_25000ft
IO360L	SEL	D	100,0	84,9	81,4	78,9	76,0	71,2	65,5	61,3	56,5	51,8	46,3
IO540	LAmx	A	2 400,0	82,2	75,8	71,7	67,3	60,6	53,5	48,7	43,4	37,7	31,6
IO540	LAmx	A	2 500,0	86,4	80,1	75,9	71,5	64,7	57,6	52,7	47,4	41,7	35,6
IO540	LAmx	A	2 700,0	94,6	88,2	83,8	79,3	72,0	63,9	58,2	52,2	45,6	38,8
IO540	LAmx	D	2 500,0	92,0	85,6	81,2	76,7	69,5	62,0	56,8	51,3	45,2	38,8
IO540	LAmx	D	2 700,0	99,0	92,6	88,3	83,8	76,6	68,7	63,1	56,9	50,0	42,7
IO540	SEL	A	2 400,0	82,7	79,3	77,0	74,6	70,8	66,6	63,5	60,1	56,1	51,7
IO540	SEL	A	2 500,0	86,6	83,2	80,8	78,4	74,4	70,2	67,1	63,7	59,8	55,4
IO540	SEL	A	2 700,0	92,9	89,5	87,2	84,6	80,5	75,8	72,2	68,2	63,6	58,4
IO540	SEL	D	2 500,0	91,8	88,3	85,8	83,2	78,9	74,1	70,8	67,1	63,0	58,3
IO540	SEL	D	2 700,0	96,8	93,5	91,1	88,6	84,3	79,4	75,7	71,5	66,7	61,4
JT15D1	LAmx	A	300,0	83,2	76,3	71,5	66,5	58,6	50,1	43,9	37,1	29,5	21,0
JT15D1	LAmx	A	600,0	85,7	78,8	74,0	69,0	61,1	52,6	46,4	39,6	32,0	23,5
JT15D1	LAmx	D	1 200,0	93,2	86,2	81,3	76,0	67,6	58,4	51,8	44,6	36,7	28,1
JT15D1	LAmx	D	1 550,0	95,3	88,6	83,9	79,0	71,1	62,3	55,7	48,4	40,1	31,0
JT15D1	SEL	A	300,0	85,6	81,0	77,7	74,2	68,5	62,3	57,6	52,3	46,2	39,2
JT15D1	SEL	A	600,0	86,8	82,2	78,9	75,4	69,7	63,5	58,8	53,5	47,4	40,4
JT15D1	SEL	D	1 200,0	96,4	91,7	88,2	84,5	78,3	71,4	66,3	60,6	54,2	47,1
JT15D1	SEL	D	1 550,0	98,0	93,6	90,4	87,0	81,4	74,8	69,7	63,9	57,1	49,5
JT15D5	LAmx	A	670,0	90,2	82,7	77,2	71,2	61,7	52,0	45,5	38,5	30,7	21,2

NPD_ID	Noise metric	Op type	Power setting (the 'Power Parameter' field in the 'Aircraft' table specifies the power setting type and unit)	L_200ft	L_400ft	L_630ft	L_1000ft	L_2000ft	L_4000ft	L_6300ft	L_10000ft	L_16000ft	L_25000ft
JT15D5	LAmx	A	1 500,0	101,3	94,4	89,6	84,4	75,8	67,2	61,3	54,4	46,4	37,5
JT15D5	LAmx	D	1 500,0	101,3	94,4	89,6	84,4	75,8	67,2	61,3	54,4	46,4	37,5
JT15D5	LAmx	D	2 100,0	103,7	97,2	92,6	87,8	80,1	72,0	66,0	59,2	51,1	42,2
JT15D5	SEL	A	670,0	90,2	85,6	82,2	78,4	72,3	65,3	60,3	54,7	48,4	41,4
JT15D5	SEL	A	1 500,0	104,1	99,8	96,8	93,4	87,3	81,1	76,6	71,3	64,8	57,4
JT15D5	SEL	D	1 500,0	104,1	99,8	96,8	93,4	87,3	81,1	76,6	71,3	64,8	57,4
JT15D5	SEL	D	2 100,0	106,0	102,4	99,7	96,8	91,6	85,7	81,2	75,9	69,3	61,8
JT3D	LAmx	A	4 000,0	111,8	104,5	98,9	93,0	81,8	67,8	59,2	50,9	41,8	32,9
JT3D	LAmx	A	6 000,0	114,0	106,8	101,5	95,5	84,6	71,3	63,3	55,3	46,4	37,2
JT3D	LAmx	D	8 000,0	115,9	109,0	103,7	98,0	87,6	75,4	67,7	59,8	51,1	42,1
JT3D	LAmx	D	10 000,0	117,5	110,8	105,6	100,0	90,4	79,5	71,8	63,8	55,2	46,5
JT3D	LAmx	D	12 000,0	118,2	111,5	106,4	101,0	92,1	82,0	74,5	66,8	58,6	49,7
JT3D	LAmx	D	15 000,0	119,7	113,0	107,9	102,5	94,0	85,0	78,1	70,3	62,0	53,5
JT3D	SEL	A	4 000,0	112,5	107,5	103,6	99,0	90,0	78,3	71,2	64,5	57,0	49,5
JT3D	SEL	A	6 000,0	114,8	109,8	105,9	101,5	92,8	81,8	75,2	68,9	61,7	54,1
JT3D	SEL	D	8 000,0	117,1	112,0	108,2	104,0	95,9	85,9	79,6	73,4	66,1	58,6
JT3D	SEL	D	10 000,0	119,0	113,9	110,1	106,0	98,5	90,0	83,7	77,5	70,1	62,8
JT3D	SEL	D	12 000,0	120,7	115,6	111,9	107,7	100,8	92,6	87,1	81,0	73,9	66,5
JT3D	SEL	D	15 000,0	122,5	117,4	113,6	109,5	103,1	96,4	90,8	85,1	77,9	70,4
JT3DQ	LAmx	A	3 000,0	102,8	95,2	89,6	83,1	74,3	65,0	58,4	51,0	42,6	34,0

NPD_ID	Noise metric	Op type	Power setting (the 'Power Parameter' field in the 'Aircraft' table specifies the power setting type and unit)	L_200ft	L_400ft	L_630ft	L_1000ft	L_2000ft	L_4000ft	L_6300ft	L_10000ft	L_16000ft	L_25000ft
JT3DQ	LAmx	A	5 000,0	105,2	96,2	89,9	84,4	75,7	66,2	59,5	52,1	43,9	35,5
JT3DQ	LAmx	D	11 000,0	107,5	100,8	96,3	91,4	83,5	75,0	68,7	61,7	53,6	45,3
JT3DQ	LAmx	D	15 500,0	114,2	107,7	103,2	98,7	91,4	83,7	78,2	72,0	64,9	57,3
JT3DQ	SEL	A	3 000,0	104,4	99,4	95,6	91,4	84,8	77,8	72,6	66,7	59,9	52,7
JT3DQ	SEL	A	5 000,0	105,1	100,0	96,2	91,9	85,4	78,4	73,2	67,3	60,6	53,7
JT3DQ	SEL	D	11 000,0	109,1	105,4	102,7	99,8	95,0	88,9	84,2	78,6	72,1	65,2
JT3DQ	SEL	D	15 500,0	116,9	113,3	110,8	108,1	103,5	98,1	94,1	89,4	83,9	77,7
JT4A	LAmx	A	4 000,0	109,2	101,7	96,3	90,5	80,6	69,0	61,7	54,5	45,7	36,9
JT4A	LAmx	A	6 000,0	111,1	103,6	98,2	92,5	82,7	71,2	63,7	56,3	48,1	39,5
JT4A	LAmx	D	10 000,0	116,5	109,3	104,1	98,5	89,3	79,0	71,6	63,7	54,5	45,4
JT4A	LAmx	D	12 000,0	119,6	112,4	107,4	102,0	93,1	82,9	75,3	67,4	58,4	48,8
JT4A	LAmx	D	15 000,0	125,3	118,3	113,2	108,0	99,1	89,2	81,5	73,5	64,3	54,6
JT4A	SEL	A	4 000,0	110,8	105,4	101,2	97,0	89,6	80,6	74,3	68,6	60,9	52,7
JT4A	SEL	A	6 000,0	112,7	107,3	103,3	99,0	91,8	82,9	76,8	71,1	63,6	55,7
JT4A	SEL	D	10 000,0	117,4	112,4	108,7	104,5	97,4	89,2	83,3	76,9	69,4	61,5
JT4A	SEL	D	12 000,0	120,0	115,2	111,6	107,5	100,6	92,6	86,6	80,3	72,6	64,7
JT4A	SEL	D	15 000,0	125,5	120,8	117,6	113,5	106,9	99,3	93,3	86,6	78,7	70,6
JT9D7Q	LAmx	A	8 560,0	101,8	95,4	91,0	86,3	78,6	69,9	63,6	56,7	49,0	40,9
JT9D7Q	LAmx	A	14 000,0	103,3	96,8	92,2	87,1	79,2	70,5	64,2	57,5	49,9	41,9
JT9D7Q	LAmx	D	24 370,0	106,3	99,8	95,3	90,3	82,6	74,2	68,1	61,6	54,2	46,4

NPD_ID	Noise metric	Op type	Power setting (the 'Power Parameter' field in the 'Aircraft' table specifies the power setting type and unit)	L_200ft	L_400ft	L_630ft	L_1000ft	L_2000ft	L_4000ft	L_6300ft	L_10000ft	L_16000ft	L_25000ft
JT9D7Q	LAmx	D	34 850,0	110,0	103,8	99,4	94,7	87,2	78,7	72,7	66,0	58,6	50,8
JT9D7Q	LAmx	D	40 240,0	112,5	106,3	102,0	97,3	89,9	81,4	75,3	68,6	61,2	53,4
JT9D7Q	LAmx	D	44 940,0	115,3	109,1	104,8	100,0	92,6	84,2	78,0	71,4	63,9	56,1
JT9D7Q	SEL	A	8 560,0	103,6	99,5	96,6	93,5	88,1	81,7	77,0	71,6	65,5	58,9
JT9D7Q	SEL	A	14 000,0	105,1	100,9	97,8	94,3	88,7	82,3	77,6	72,4	66,4	59,9
JT9D7Q	SEL	D	24 370,0	108,1	103,9	100,9	97,5	92,1	86,0	81,5	76,5	70,7	64,4
JT9D7Q	SEL	D	34 850,0	111,8	107,9	105,0	101,9	96,7	90,5	86,1	80,9	75,1	68,8
JT9D7Q	SEL	D	40 240,0	114,3	110,4	107,6	104,5	99,4	93,2	88,7	83,5	77,7	71,4
JT9D7Q	SEL	D	44 940,0	117,1	113,2	110,4	107,2	102,1	96,0	91,4	86,3	80,4	74,1
JT9DBD	LAmx	A	8 000,0	106,5	99,5	94,5	89,0	79,8	69,1	61,2	53,2	44,9	36,3
JT9DBD	LAmx	A	14 000,0	111,0	104,0	99,0	93,5	84,3	73,6	65,7	57,7	49,4	40,8
JT9DBD	LAmx	D	20 000,0	114,3	107,2	102,1	96,5	87,1	76,9	69,8	62,3	54,2	45,4
JT9DBD	LAmx	D	28 000,0	116,4	109,3	104,2	98,5	89,0	79,1	72,3	65,0	57,0	48,0
JT9DBD	LAmx	D	36 000,0	117,9	110,8	105,7	100,0	90,5	80,6	73,8	66,5	58,5	49,7
JT9DBD	SEL	A	8 000,0	108,2	103,5	99,9	96,0	89,1	80,6	74,2	67,6	60,9	53,7
JT9DBD	SEL	A	14 000,0	113,2	108,5	104,9	101,0	94,1	85,6	79,2	72,6	65,9	58,7
JT9DBD	SEL	D	20 000,0	116,6	111,8	108,1	104,0	96,9	89,0	83,4	77,3	70,7	63,4
JT9DBD	SEL	D	28 000,0	118,7	113,9	110,2	106,0	98,8	91,2	85,9	80,0	73,5	66,2
JT9DBD	SEL	D	36 000,0	120,2	115,4	111,7	107,5	100,3	92,7	87,4	81,5	75,0	67,7
JT9DFL	LAmx	A	8 000,0	103,0	95,5	90,2	84,3	75,1	66,0	59,7	52,6	44,5	35,6

NPD_ID	Noise metric	Op type	Power setting (the 'Power Parameter' field in the 'Aircraft' table specifies the power setting type and unit)	L_200ft	L_400ft	L_630ft	L_1000ft	L_2000ft	L_4000ft	L_6300ft	L_10000ft	L_16000ft	L_25000ft
JT9DFL	LAmx	A	16 000,0	107,1	99,6	94,3	88,4	79,2	70,1	63,8	56,7	48,6	39,7
JT9DFL	LAmx	D	24 000,0	110,6	103,1	97,8	92,1	83,3	74,5	68,3	61,5	53,7	45,4
JT9DFL	LAmx	D	32 000,0	113,5	105,9	100,6	95,1	86,5	77,9	71,9	65,3	57,7	49,7
JT9DFL	LAmx	D	40 000,0	115,7	108,1	102,8	97,3	88,7	80,1	74,1	67,5	59,9	51,9
JT9DFL	SEL	A	8 000,0	102,3	97,8	94,3	90,5	84,4	77,7	72,9	67,3	60,7	53,3
JT9DFL	SEL	A	16 000,0	106,3	101,8	98,3	94,5	88,4	81,7	76,9	71,3	64,7	57,3
JT9DFL	SEL	D	24 000,0	109,4	105,1	101,7	98,0	92,2	85,8	81,2	75,9	69,7	62,8
JT9DFL	SEL	D	32 000,0	111,8	107,4	104,1	100,5	94,9	88,7	84,2	79,1	73,1	66,5
JT9DFL	SEL	D	40 000,0	113,8	109,4	106,1	102,5	96,9	90,7	86,2	81,1	75,1	68,5
O320D3	LAmx	A	1 500,0	66,9	60,5	56,2	51,7	44,7	37,2	32,1	26,7	21,1	15,9
O320D3	LAmx	A	1 600,0	68,1	61,7	57,4	52,9	45,9	38,4	33,2	27,7	21,9	16,6
O320D3	LAmx	A	1 800,0	72,1	65,6	61,2	56,6	49,3	41,3	35,8	30,0	23,9	18,0
O320D3	LAmx	D	2 150,0	79,8	73,1	68,6	63,9	56,2	47,9	42,2	36,1	29,7	23,1
O320D3	LAmx	D	2 442,0	87,3	80,7	76,1	71,2	63,5	55,1	49,4	43,1	36,1	28,7
O320D3	LAmx	D	2 600,0	88,8	82,1	77,5	72,6	64,7	56,2	50,2	43,8	36,7	29,3
O320D3	SEL	A	1 500,0	69,0	65,6	62,8	60,2	56,0	51,3	48,0	44,5	41,3	38,2
O320D3	SEL	A	1 600,0	70,4	67,1	64,6	62,0	57,7	53,0	49,6	45,9	42,3	38,9
O320D3	SEL	A	1 800,0	74,1	70,5	68,0	65,3	60,7	55,5	51,8	47,8	43,8	39,9
O320D3	SEL	D	2 150,0	80,4	76,9	74,3	71,4	66,5	60,9	57,0	52,7	48,1	43,7
O320D3	SEL	D	2 442,0	87,9	84,2	81,5	78,5	73,4	67,9	63,9	59,5	54,4	48,9

NPD_ID	Noise metric	Op type	Power setting (the 'Power Parameter' field in the 'Aircraft' table specifies the power setting type and unit)	L_200ft	L_400ft	L_630ft	L_1000ft	L_2000ft	L_4000ft	L_6300ft	L_10000ft	L_16000ft	L_25000ft
O320D3	SEL	D	2 600,0	89,4	85,5	82,8	79,8	74,8	69,0	64,8	60,2	55,0	49,2
O470R	LAmx	A	169,0	73,3	67,1	62,9	58,6	51,8	44,6	39,6	34,1	28,1	21,8
O470R	LAmx	A	244,0	73,9	67,7	63,5	59,2	52,5	45,4	40,3	34,8	28,8	22,4
O470R	LAmx	D	533,0	87,5	81,2	77,0	72,7	65,7	58,2	52,7	46,6	39,7	32,3
O470R	LAmx	D	640,0	96,1	89,8	85,5	80,9	73,5	65,0	58,6	51,3	43,0	34,3
O470R	SEL	A	169,0	75,6	71,7	69,0	66,2	61,7	56,7	53,1	49,2	44,7	39,8
O470R	SEL	A	244,0	76,2	72,3	69,6	66,8	62,3	57,3	53,7	49,7	45,1	40,2
O470R	SEL	D	533,0	87,8	83,8	81,1	78,2	73,6	68,2	64,2	59,6	54,2	48,4
O470R	SEL	D	640,0	95,4	91,3	88,5	85,4	80,3	74,1	69,2	63,4	56,5	49,3
OLY593	LAmx	A	10 000,0	115,8	109,2	104,6	99,8	92,0	83,2	76,5	68,8	60,3	50,7
OLY593	LAmx	A	20 000,0	126,4	119,4	113,3	109,2	101,2	92,4	85,9	78,7	70,2	60,7
OLY593	LAmx	D	20 000,0	126,4	119,4	113,3	109,2	101,2	92,4	85,9	78,7	70,2	60,7
OLY593	LAmx	D	28 000,0	132,1	124,8	119,6	114,3	106,1	97,3	90,8	83,6	75,1	65,3
OLY593	LAmx	D	32 000,0	134,0	126,7	121,4	116,0	107,8	98,9	92,4	85,2	76,7	67,3
OLY593	SEL	A	10 000,0	117,7	113,4	110,3	107,0	101,5	94,8	89,6	83,5	76,5	68,3
OLY593	SEL	A	20 000,0	130,3	125,5	122,0	118,3	112,6	106,1	101,1	95,3	88,3	80,3
OLY593	SEL	D	20 000,0	130,3	125,5	122,0	118,3	112,6	106,1	101,1	95,3	88,3	80,3
OLY593	SEL	D	28 000,0	136,4	131,3	127,6	123,8	118,0	111,4	106,4	100,6	93,7	85,7
OLY593	SEL	D	32 000,0	138,4	133,2	129,4	125,5	119,6	113,0	108,0	102,2	95,3	87,4
PT6A114	LAmx	A	400,0	90,0	83,6	79,4	75,0	68,0	60,4	54,8	48,3	40,5	31,7

NPD_ID	Noise metric	Op type	Power setting (the 'Power Parameter' field in the 'Aircraft' table specifies the power setting type and unit)	L_200ft	L_400ft	L_630ft	L_1000ft	L_2000ft	L_4000ft	L_6300ft	L_10000ft	L_16000ft	L_25000ft
PT6A114	LAmx	A	427,0	90,0	83,6	79,4	75,0	68,0	60,4	54,8	48,3	40,5	31,7
PT6A114	LAmx	A	463,0	90,3	84,0	79,7	75,2	68,2	60,6	55,1	48,7	41,1	32,6
PT6A114	LAmx	D	1 009,0	88,2	82,0	77,8	73,5	66,7	59,1	53,5	47,1	39,4	30,8
PT6A114	LAmx	D	1 899,0	90,0	83,8	79,7	75,4	68,7	61,4	56,1	50,1	43,1	35,4
PT6A114	SEL	A	400,0	89,9	85,8	83,0	80,1	75,4	70,1	65,9	61,0	54,7	47,4
PT6A114	SEL	A	427,0	89,9	85,8	83,0	80,1	75,4	70,1	65,9	61,0	54,7	47,4
PT6A114	SEL	A	463,0	89,4	85,3	82,4	79,4	74,7	69,3	65,3	60,6	54,7	47,9
PT6A114	SEL	D	1 009,0	87,7	83,8	81,1	78,3	73,7	68,4	64,3	59,4	53,2	46,1
PT6A114	SEL	D	1 899,0	89,7	85,8	83,2	80,4	75,9	70,9	67,1	62,6	57,1	50,9
PT6A27	LAmx	A	30,0	90,9	84,6	80,4	76,0	69,1	61,6	56,0	49,8	42,6	34,0
PT6A27	LAmx	A	100,0	95,6	89,5	85,3	81,0	74,3	67,0	61,6	55,6	49,0	41,4
PT6A27	LAmx	D	30,0	90,9	84,6	80,4	76,0	69,1	61,6	56,0	49,8	42,6	34,0
PT6A27	LAmx	D	100,0	95,6	89,5	85,3	81,0	74,3	67,0	61,6	55,6	49,0	41,4
PT6A27	SEL	A	30,0	91,3	87,2	84,4	81,6	76,9	71,7	67,6	62,9	57,2	50,0
PT6A27	SEL	A	100,0	95,9	92,0	89,3	86,5	82,0	77,0	73,1	68,6	63,5	57,4
PT6A27	SEL	D	30,0	91,3	87,2	84,4	81,6	76,9	71,7	67,6	62,9	57,2	50,0
PT6A27	SEL	D	100,0	95,9	92,0	89,3	86,5	82,0	77,0	73,1	68,6	63,5	57,4
PT6A41	LAmx	A	300,0	83,6	77,2	72,8	68,2	60,9	52,8	47,0	40,4	32,8	24,9
PT6A41	LAmx	A	311,0	83,6	77,2	72,8	68,2	60,9	52,8	47,0	40,4	32,8	24,9
PT6A41	LAmx	D	820,0	85,2	78,9	74,7	70,3	63,5	56,0	50,6	44,4	37,2	29,1

NPD_ID	Noise metric	Op type	Power setting (the 'Power Parameter' field in the 'Aircraft' table specifies the power setting type and unit)	L_200ft	L_400ft	L_630ft	L_1000ft	L_2000ft	L_4000ft	L_6300ft	L_10000ft	L_16000ft	L_25000ft
PT6A41	LAmx	D	1 153,0	87,2	81,0	76,9	72,6	65,9	58,6	53,4	47,5	40,6	32,9
PT6A41	SEL	A	300,0	87,8	83,6	80,7	77,6	72,5	66,7	62,3	57,3	51,3	44,8
PT6A41	SEL	A	311,0	87,8	83,6	80,7	77,6	72,5	66,7	62,3	57,3	51,3	44,8
PT6A41	SEL	D	820,0	86,6	82,5	79,8	77,0	72,3	67,1	63,2	58,5	52,8	46,3
PT6A41	SEL	D	1 153,0	88,6	84,7	82,0	79,2	74,8	69,8	66,0	61,6	56,2	50,0
PT6A45	LAmx	A	35,0	87,2	81,0	76,7	72,4	65,1	57,7	52,9	48,0	41,9	35,1
PT6A45	LAmx	A	65,0	87,8	81,4	77,0	72,5	64,9	57,4	52,4	47,4	41,7	35,5
PT6A45	LAmx	D	65,0	87,8	81,4	77,0	72,5	64,9	57,4	52,4	47,4	41,7	35,5
PT6A45	LAmx	D	100,0	94,9	88,6	84,4	80,0	72,6	65,2	60,3	55,4	49,4	42,4
PT6A45	SEL	A	35,0	88,0	84,0	81,3	78,5	74,0	69,2	65,6	61,6	57,0	51,6
PT6A45	SEL	A	65,0	88,5	84,4	81,5	78,5	73,7	68,5	64,8	60,9	56,8	52,0
PT6A45	SEL	D	65,0	88,5	84,4	81,5	78,5	73,7	68,5	64,8	60,9	56,8	52,0
PT6A45	SEL	D	100,0	95,1	91,1	88,4	85,5	81,0	76,1	72,4	68,4	63,8	58,4
PT6A50	LAmx	A	35,0	83,9	78,2	74,0	68,8	60,7	51,8	45,5	38,6	31,4	24,2
PT6A50	LAmx	A	40,0	87,4	81,7	77,5	72,4	64,2	55,5	49,0	42,1	34,4	26,7
PT6A50	LAmx	D	80,0	84,7	78,5	74,4	69,8	62,5	54,0	48,1	41,3	34,0	26,4
PT6A50	LAmx	D	100,0	86,9	80,7	76,6	72,0	64,7	56,2	50,2	43,5	36,4	29,3
PT6A50	SEL	A	35,0	85,7	82,3	79,6	76,0	70,2	63,6	58,9	53,5	47,9	42,2
PT6A50	SEL	A	40,0	89,2	85,8	83,1	79,6	73,7	67,3	62,4	57,0	50,9	44,7
PT6A50	SEL	D	80,0	86,5	82,6	80,0	77,0	72,0	65,8	61,5	56,2	50,5	44,4

NPD_ID	Noise metric	Op type	Power setting (the 'Power Parameter' field in the 'Aircraft' table specifies the power setting type and unit)	L_200ft	L_400ft	L_630ft	L_1000ft	L_2000ft	L_4000ft	L_6300ft	L_10000ft	L_16000ft	L_25000ft
PT6A50	SEL	D	100,0	88,7	84,8	82,2	79,2	74,2	68,0	63,6	58,4	52,9	47,3
PT6A67	LAmx	A	400,0	87,8	81,2	76,8	72,2	64,9	56,7	50,6	43,5	35,4	27,1
PT6A67	LAmx	A	600,0	89,1	82,4	77,9	73,3	66,1	58,1	52,3	45,7	37,8	29,2
PT6A67	LAmx	D	1 000,0	90,2	83,7	79,2	74,5	67,0	58,8	52,9	46,7	39,9	33,2
PT6A67	LAmx	D	1 100,0	90,2	83,7	79,2	74,5	67,0	58,8	52,9	46,7	39,9	33,2
PT6A67	LAmx	D	1 600,0	87,9	81,5	77,2	72,7	65,7	58,1	52,7	46,9	40,5	34,0
PT6A67	LAmx	D	1 700,0	87,9	81,5	77,2	72,7	65,7	58,1	52,7	46,9	40,5	34,0
PT6A67	SEL	A	400,0	90,6	86,4	83,9	81,0	76,3	70,7	66,2	60,9	54,6	48,2
PT6A67	SEL	A	600,0	90,8	86,6	83,9	80,9	76,3	71,0	66,8	61,8	55,7	48,8
PT6A67	SEL	D	1 000,0	92,8	88,9	86,3	83,3	78,4	72,7	68,5	63,9	58,8	53,6
PT6A67	SEL	D	1 100,0	92,8	88,9	86,3	83,3	78,4	72,7	68,5	63,9	58,8	53,6
PT6A67	SEL	D	1 600,0	89,4	85,7	83,2	80,5	76,0	70,9	67,2	63,1	58,5	53,7
PT6A67	SEL	D	1 700,0	89,4	85,7	83,2	80,5	76,0	70,9	67,2	63,1	58,5	53,7
PW119C	LAmx	A	108,0	91,0	84,0	79,0	73,6	64,7	55,1	48,4	41,1	33,2	25,4
PW119C	LAmx	A	465,0	91,8	84,6	79,4	73,7	64,1	53,6	46,5	39,0	31,1	22,9
PW119C	LAmx	D	3 412,0	87,2	80,6	76,2	71,5	64,3	56,5	51,0	44,9	38,3	31,6
PW119C	LAmx	D	4 300,0	88,8	82,4	78,2	73,8	67,0	59,9	55,0	49,7	43,9	37,8
PW119C	LAmx	D	4 301,0	88,8	82,4	78,2	73,8	67,0	59,9	55,0	49,7	43,9	37,8
PW119C	SEL	A	108,0	95,0	90,3	86,8	82,8	76,2	68,8	63,6	57,8	51,4	45,1
PW119C	SEL	A	465,0	95,3	90,4	86,7	82,5	75,1	66,9	61,3	55,3	48,8	42,2

NPD_ID	Noise metric	Op type	Power setting (the 'Power Parameter' field in the 'Aircraft' table specifies the power setting type and unit)	L_200ft	L_400ft	L_630ft	L_1000ft	L_2000ft	L_4000ft	L_6300ft	L_10000ft	L_16000ft	L_25000ft
PW119C	SEL	D	3 412,0	90,0	85,7	82,7	79,6	74,6	69,1	65,0	60,5	55,4	50,1
PW119C	SEL	D	4 300,0	90,2	86,0	83,2	80,3	75,8	71,0	67,6	63,8	59,5	54,8
PW119C	SEL	D	4 301,0	90,2	86,0	83,2	80,3	75,8	71,0	67,6	63,8	59,5	54,8
PW120	LAmx	A	35,0	87,1	80,3	75,5	70,5	62,4	54,0	48,9	43,8	39,1	34,8
PW120	LAmx	A	40,0	90,0	83,7	79,2	74,3	66,7	59,0	54,0	48,8	43,4	38,1
PW120	LAmx	D	90,0	82,8	76,9	72,9	68,7	62,8	56,3	51,8	47,3	42,3	37,6
PW120	LAmx	D	100,0	85,2	79,4	75,8	71,9	65,9	59,7	55,3	51,0	46,2	41,6
PW120	LAmx	D	150,0	90,2	84,4	80,8	76,9	70,9	64,7	60,3	56,0	51,2	46,6
PW120	SEL	A	35,0	88,9	84,4	81,1	77,7	71,9	65,8	62,3	58,7	55,6	52,8
PW120	SEL	A	40,0	91,8	87,8	84,8	81,5	76,2	70,8	67,4	63,7	59,9	56,1
PW120	SEL	D	90,0	84,6	81,0	78,5	75,9	72,3	68,1	65,2	62,2	58,8	55,6
PW120	SEL	D	100,0	87,0	83,5	81,4	79,1	75,4	71,5	68,7	65,9	62,7	59,6
PW120	SEL	D	150,0	92,0	88,5	86,4	84,1	80,4	76,5	73,7	70,9	67,7	64,6
PW2037	LAmx	A	5 000,0	93,3	86,7	82,1	77,1	69,2	60,2	53,4	46,2	38,2	30,2
PW2037	LAmx	A	12 000,0	97,8	90,9	86,1	80,9	72,6	63,4	56,5	49,0	40,7	32,4
PW2037	LAmx	D	13 000,0	95,6	89,2	84,6	79,6	71,4	62,1	55,2	47,6	39,3	30,8
PW2037	LAmx	D	24 000,0	99,7	93,1	88,4	83,2	75,2	66,1	59,8	53,3	46,2	39,0
PW2037	LAmx	D	30 000,0	101,5	95,5	91,1	86,4	78,8	70,1	63,7	57,0	49,5	41,9
PW2037	LAmx	D	36 000,0	103,7	98,4	94,6	90,5	83,8	75,5	68,9	61,6	53,2	44,6
PW2037	SEL	A	5 000,0	95,1	90,8	87,7	84,3	78,7	72,0	66,8	61,1	54,7	48,2

NPD_ID	Noise metric	Op type	Power setting (the 'Power Parameter' field in the 'Aircraft' table specifies the power setting type and unit)	L_200ft	L_400ft	L_630ft	L_1000ft	L_2000ft	L_4000ft	L_6300ft	L_10000ft	L_16000ft	L_25000ft
PW2037	SEL	A	12 000,0	99,6	95,0	91,7	88,1	82,1	75,2	69,9	63,9	57,2	50,4
PW2037	SEL	D	13 000,0	97,4	93,3	90,2	86,8	80,9	73,9	68,6	62,5	55,8	48,8
PW2037	SEL	D	24 000,0	101,5	97,2	94,0	90,4	84,7	77,9	73,2	68,2	62,7	57,0
PW2037	SEL	D	30 000,0	103,3	99,6	96,7	93,6	88,3	81,9	77,1	71,9	66,0	59,9
PW2037	SEL	D	36 000,0	105,5	102,5	100,2	97,7	93,3	87,3	82,3	76,5	69,7	62,6
PW306C	LAmx	A	500,0	84,2	77,2	72,2	66,8	58,1	48,7	42,1	35,1	27,7	20,3
PW306C	LAmx	A	1 000,0	85,4	78,1	73,0	67,6	58,8	49,4	42,8	35,9	28,5	21,3
PW306C	LAmx	D	1 500,0	86,2	79,5	74,7	69,4	60,7	51,2	44,5	37,2	29,5	21,8
PW306C	LAmx	D	3 500,0	95,2	88,8	84,1	78,9	70,3	60,8	54,1	46,9	39,1	31,3
PW306C	LAmx	D	5 500,0	101,4	95,1	90,4	85,2	76,5	66,8	60,0	52,6	44,6	36,5
PW306C	SEL	A	500,0	85,4	81,5	78,6	75,2	69,3	62,7	57,8	52,6	46,8	41,0
PW306C	SEL	A	1 000,0	86,5	82,4	79,3	75,8	69,9	63,3	58,5	53,4	47,8	42,1
PW306C	SEL	D	1 500,0	85,8	82,3	79,5	76,2	70,6	64,0	59,1	53,8	47,9	41,9
PW306C	SEL	D	3 500,0	94,9	91,3	88,4	85,2	79,5	72,9	68,1	62,9	57,1	51,2
PW306C	SEL	D	5 500,0	101,3	97,9	95,1	91,9	86,3	79,8	75,0	69,7	64,0	58,1
PW4056	LAmx	A	7 000,0	99,8	92,4	87,3	82,0	74,1	65,7	59,6	52,8	45,8	39,1
PW4056	LAmx	A	10 000,0	99,9	92,4	87,3	82,0	74,2	65,8	59,7	52,8	45,8	39,0
PW4056	LAmx	A	13 000,0	100,5	92,9	87,7	82,4	74,5	66,1	60,0	53,1	46,1	39,4
PW4056	LAmx	A	16 000,0	101,4	93,6	88,2	82,9	74,9	66,5	60,4	53,6	46,6	40,0
PW4056	LAmx	D	20 000,0	101,9	94,4	89,3	83,9	75,7	67,7	61,9	55,5	49,1	42,9

NPD_ID	Noise metric	Op type	Power setting (the 'Power Parameter' field in the 'Aircraft' table specifies the power setting type and unit)	L_200ft	L_400ft	L_630ft	L_1000ft	L_2000ft	L_4000ft	L_6300ft	L_10000ft	L_16000ft	L_25000ft
PW4056	LAmx	D	26 000,0	103,4	96,2	91,2	86,1	78,0	69,7	64,0	57,6	51,1	44,9
PW4056	LAmx	D	32 000,0	105,1	98,0	93,2	88,1	80,2	71,8	66,0	59,7	53,2	47,0
PW4056	LAmx	D	38 000,0	107,0	100,1	95,3	90,4	82,5	74,1	68,3	61,9	55,4	49,2
PW4056	LAmx	D	44 000,0	109,5	102,7	98,0	93,1	85,3	76,9	71,2	64,8	58,3	52,2
PW4056	LAmx	D	50 000,0	113,3	106,5	101,7	96,9	89,1	81,0	75,3	68,9	62,5	56,4
PW4056	SEL	A	7 000,0	102,9	98,2	94,9	91,5	86,1	80,1	75,6	70,5	65,2	60,1
PW4056	SEL	A	10 000,0	103,3	98,6	95,2	91,7	86,3	80,3	75,8	70,6	65,2	60,1
PW4056	SEL	A	13 000,0	103,9	99,1	95,7	92,1	86,6	80,6	76,1	70,9	65,6	60,6
PW4056	SEL	A	16 000,0	104,6	99,8	96,3	92,6	87,0	80,9	76,5	71,4	66,3	61,4
PW4056	SEL	D	20 000,0	104,5	99,9	96,5	92,7	86,9	81,1	77,1	72,6	68,0	63,6
PW4056	SEL	D	26 000,0	105,0	100,7	97,5	94,1	88,7	83,0	79,0	74,5	70,0	65,6
PW4056	SEL	D	32 000,0	106,1	102,0	99,0	95,8	90,6	85,0	81,0	76,5	72,0	67,6
PW4056	SEL	D	38 000,0	107,6	103,6	100,8	97,7	92,7	87,2	83,3	78,8	74,3	69,9
PW4056	SEL	D	44 000,0	109,9	106,0	103,2	100,2	95,4	90,0	86,2	81,8	77,3	73,0
PW4056	SEL	D	50 000,0	113,5	109,6	106,9	104,0	99,2	94,2	90,5	86,1	81,7	77,5
PW4158	LAmx	A	4 000,0	97,0	90,1	84,8	78,9	70,6	62,1	56,0	49,2	41,5	33,6
PW4158	LAmx	A	12 000,0	99,5	92,3	86,8	81,1	72,4	63,4	57,2	50,2	42,5	34,5
PW4158	LAmx	D	23 000,0	104,9	95,7	89,4	83,0	73,2	62,8	56,1	49,2	41,7	34,0
PW4158	LAmx	D	32 000,0	107,8	99,8	94,4	88,6	79,1	68,1	61,4	54,6	47,0	39,0
PW4158	LAmx	D	41 000,0	108,7	101,0	95,9	90,3	81,0	71,5	65,1	58,2	50,5	42,4

NPD_ID	Noise metric	Op type	Power setting (the 'Power Parameter' field in the 'Aircraft' table specifies the power setting type and unit)	L_200ft	L_400ft	L_630ft	L_1000ft	L_2000ft	L_4000ft	L_6300ft	L_10000ft	L_16000ft	L_25000ft
PW4158	LAmx	D	50 000,0	111,5	103,9	98,9	93,7	85,4	76,6	70,4	63,7	56,0	47,6
PW4158	SEL	A	4 000,0	99,7	94,9	91,6	88,2	82,7	76,6	72,0	66,8	60,8	54,3
PW4158	SEL	A	12 000,0	102,5	97,8	94,1	90,2	84,2	77,8	73,1	67,8	61,6	55,1
PW4158	SEL	D	23 000,0	104,1	98,5	94,2	90,0	83,7	76,8	71,9	66,8	61,0	54,7
PW4158	SEL	D	32 000,0	106,1	101,4	97,6	94,0	88,1	81,6	77,0	72,0	66,2	60,0
PW4158	SEL	D	41 000,0	107,3	103,1	99,7	96,4	91,0	85,0	80,6	75,7	70,1	63,8
PW4158	SEL	D	50 000,0	110,6	106,5	103,4	100,2	95,1	89,5	85,3	80,4	74,6	68,1
PW4460	LAmx	A	9 300,0	99,2	92,8	87,4	82,4	74,1	65,9	59,6	53,2	46,6	40,4
PW4460	LAmx	A	22 400,0	102,5	95,6	90,5	84,9	76,3	67,5	61,2	54,8	48,1	41,7
PW4460	LAmx	D	24 960,0	101,9	94,1	89,1	84,0	76,2	67,6	61,3	54,8	47,2	40,0
PW4460	LAmx	D	37 100,0	104,4	97,1	92,4	87,5	80,2	71,9	65,8	59,1	51,7	44,7
PW4460	LAmx	D	49 010,0	107,4	100,9	96,4	91,9	84,7	76,9	70,8	64,4	56,7	50,2
PW4460	LAmx	D	53 830,0	109,6	103,2	98,6	94,0	87,3	79,4	73,8	67,1	59,7	53,2
PW4460	SEL	A	9 300,0	101,0	96,9	93,0	89,6	83,6	77,7	73,0	68,1	63,1	58,4
PW4460	SEL	A	22 400,0	104,3	99,7	96,1	92,1	85,8	79,3	74,6	69,7	64,6	59,7
PW4460	SEL	D	24 960,0	103,7	98,2	94,7	91,2	85,7	79,4	74,7	69,7	63,7	58,0
PW4460	SEL	D	37 100,0	106,2	101,2	98,0	94,7	89,7	83,7	79,2	74,0	68,2	62,7
PW4460	SEL	D	49 010,0	109,2	105,0	102,0	99,1	94,2	88,7	84,2	79,3	73,2	68,2
PW4460	SEL	D	53 830,0	111,4	107,3	104,2	101,2	96,8	91,2	87,2	82,0	76,2	71,2
PW530A	LAmx	A	500,0	88,7	81,1	75,8	70,1	60,9	51,1	44,3	37,1	29,4	21,9

NPD_ID	Noise metric	Op type	Power setting (the 'Power Parameter' field in the 'Aircraft' table specifies the power setting type and unit)	L_200ft	L_400ft	L_630ft	L_1000ft	L_2000ft	L_4000ft	L_6300ft	L_10000ft	L_16000ft	L_25000ft
PW530A	LAmx	A	800,0	90,3	82,7	77,5	71,8	62,9	53,3	46,7	39,7	32,3	25,0
PW530A	LAmx	D	1 200,0	94,0	87,0	81,9	76,3	67,2	57,2	50,1	42,6	34,5	26,4
PW530A	LAmx	D	1 600,0	95,8	89,1	84,2	78,9	70,0	60,3	53,4	45,9	38,0	30,0
PW530A	LAmx	D	2 000,0	98,5	91,8	86,8	81,4	72,4	62,5	55,5	47,9	39,8	31,7
PW530A	LAmx	D	2 400,0	100,2	93,6	88,8	83,5	74,7	65,0	58,1	50,7	42,8	34,8
PW530A	SEL	A	500,0	88,6	84,0	80,7	77,1	71,1	64,4	59,7	54,6	49,2	43,7
PW530A	SEL	A	800,0	90,4	85,8	82,5	78,9	73,0	66,6	62,0	57,1	51,8	46,6
PW530A	SEL	D	1 200,0	92,2	88,0	84,8	81,3	75,3	68,5	63,7	58,4	52,6	46,9
PW530A	SEL	D	1 600,0	95,5	91,5	88,4	84,8	78,8	71,9	66,9	61,4	55,5	49,5
PW530A	SEL	D	2 000,0	98,8	94,4	91,2	87,5	81,4	74,6	69,7	64,5	58,7	53,0
PW530A	SEL	D	2 400,0	100,2	96,4	93,5	90,1	84,2	77,4	72,5	67,0	61,1	55,0
PW545A	LAmx	A	550,0	91,5	84,2	78,9	73,1	63,6	53,3	46,0	38,2	29,9	21,6
PW545A	LAmx	A	750,0	93,0	85,6	80,3	74,5	65,1	54,7	47,4	39,6	31,3	23,0
PW545A	LAmx	D	1 750,0	94,4	87,6	82,7	77,3	68,3	58,5	51,5	44,0	35,9	27,8
PW545A	LAmx	D	2 000,0	94,6	87,6	82,5	77,1	68,3	58,7	52,1	45,0	37,5	30,0
PW545A	LAmx	D	2 500,0	96,4	89,3	84,3	78,9	70,1	60,6	53,9	46,8	39,3	31,8
PW545A	LAmx	D	3 000,0	97,4	90,8	86,1	81,0	72,6	63,5	57,1	50,2	42,8	35,5
PW545A	LAmx	D	3 500,0	99,7	93,2	88,5	83,4	75,1	66,0	59,6	52,8	45,6	38,3
PW545A	SEL	A	550,0	92,1	87,1	83,4	79,1	71,7	63,4	57,4	50,8	43,6	36,4
PW545A	SEL	A	750,0	93,6	88,6	84,8	80,5	73,2	64,9	58,9	52,4	45,3	38,1
PW545A	SEL	D	1 750,0	94,8	90,3	86,9	83,0	76,3	68,7	63,2	57,2	50,6	44,0

NPD_ID	Noise metric	Op type	Power setting (the 'Power Parameter' field in the 'Aircraft' table specifies the power setting type and unit)	L_200ft	L_400ft	L_630ft	L_1000ft	L_2000ft	L_4000ft	L_6300ft	L_10000ft	L_16000ft	L_25000ft
PW545A	SEL	D	2 000,0	95,9	91,1	87,5	83,6	77,1	69,8	64,7	59,1	53,1	47,1
PW545A	SEL	D	2 500,0	98,0	93,2	89,6	85,7	79,2	71,9	66,8	61,2	55,2	49,2
PW545A	SEL	D	3 000,0	98,7	94,4	91,2	87,6	81,5	74,6	69,7	64,3	58,5	52,6
PW545A	SEL	D	3 500,0	101,1	96,8	93,6	90,1	84,0	77,2	72,3	67,0	61,3	55,5
PW610F	LAmx	A	79,0	77,0	69,5	64,6	59,8	52,4	44,4	38,6	32,1	24,5	16,3
PW610F	LAmx	A	112,0	77,3	69,8	64,9	59,9	52,4	44,3	38,5	32,0	24,5	16,2
PW610F	LAmx	A	160,0	77,9	70,4	65,4	60,3	52,5	44,4	38,5	32,0	24,5	16,2
PW610F	LAmx	A	208,0	78,5	71,0	66,0	60,8	52,9	44,6	38,7	32,1	24,6	16,3
PW610F	LAmx	A	262,0	79,2	71,8	66,8	61,5	53,5	45,0	39,0	32,4	24,8	16,6
PW610F	LAmx	A	328,0	80,1	72,9	67,9	62,7	54,5	45,8	39,7	32,9	25,2	17,0
PW610F	LAmx	A	404,0	81,2	74,3	69,5	64,3	56,1	47,1	40,7	33,8	26,0	17,7
PW610F	LAmx	D	489,0	83,7	76,9	72,1	66,9	58,4	48,9	42,1	34,6	26,1	17,0
PW610F	LAmx	D	587,0	86,2	79,1	74,2	68,9	60,4	50,9	44,0	36,4	27,8	18,7
PW610F	LAmx	D	689,0	88,3	81,2	76,2	70,9	62,3	52,9	46,0	38,3	29,6	20,4
PW610F	LAmx	D	807,0	90,3	83,3	78,3	73,1	64,6	55,2	48,3	40,5	31,8	22,6
PW610F	LAmx	D	910,0	91,7	84,8	80,0	74,9	66,5	57,1	50,2	42,5	33,7	24,4
PW610F	LAmx	D	935,0	91,9	85,1	80,4	75,3	67,0	57,6	50,7	43,0	34,2	24,9
PW610F	SEL	A	79,0	78,5	74,3	71,3	68,3	63,5	58,1	54,0	49,2	43,4	36,9
PW610F	SEL	A	112,0	78,7	74,4	71,5	68,4	63,5	58,1	54,0	49,1	43,4	36,8
PW610F	SEL	A	160,0	79,0	74,7	71,8	68,7	63,7	58,2	54,0	49,2	43,4	36,8
PW610F	SEL	A	208,0	79,5	75,2	72,3	69,2	64,1	58,4	54,2	49,3	43,5	36,9

NPD_ID	Noise metric	Op type	Power setting (the 'Power Parameter' field in the 'Aircraft' table specifies the power setting type and unit)	L_200ft	L_400ft	L_630ft	L_1000ft	L_2000ft	L_4000ft	L_6300ft	L_10000ft	L_16000ft	L_25000ft
PW610F	SEL	A	262,0	80,1	75,9	72,9	69,8	64,7	58,9	54,7	49,7	43,8	37,2
PW610F	SEL	A	328,0	81,0	76,9	74,0	70,8	65,7	59,8	55,5	50,4	44,4	37,7
PW610F	SEL	A	404,0	82,2	78,3	75,5	72,4	67,2	61,3	56,8	51,6	45,4	38,6
PW610F	SEL	D	489,0	83,4	79,6	76,8	73,6	68,4	62,1	57,3	51,7	44,9	37,5
PW610F	SEL	D	587,0	85,7	81,9	78,9	75,7	70,4	64,2	59,4	53,8	47,0	39,6
PW610F	SEL	D	689,0	87,9	84,1	81,0	77,7	72,4	66,3	61,5	55,9	49,2	41,7
PW610F	SEL	D	807,0	90,1	86,3	83,4	80,1	74,9	68,7	64,0	58,4	51,7	44,1
PW610F	SEL	D	910,0	91,8	88,1	85,3	82,2	77,0	70,8	66,1	60,5	53,7	46,1
PW610F	SEL	D	935,0	92,2	88,4	85,7	82,7	77,5	71,3	66,6	60,9	54,2	46,6
PW615F	LAmx	A	300,0	82,8	75,7	70,6	65,1	56,1	46,3	39,5	32,2	24,4	16,6
PW615F	LAmx	A	500,0	87,1	79,9	74,7	69,0	59,8	49,7	42,6	35,0	26,9	18,8
PW615F	LAmx	D	700,0	90,2	83,5	78,6	73,1	64,1	54,0	46,9	39,2	31,0	22,7
PW615F	LAmx	D	900,0	94,8	87,7	82,6	77,0	67,7	57,5	50,3	42,5	34,2	25,9
PW615F	LAmx	D	1 100,0	96,4	89,8	85,0	79,6	70,6	60,5	53,4	45,7	37,3	28,9
PW615F	LAmx	D	1 300,0	97,4	91,1	86,4	81,2	72,5	62,7	55,8	48,3	40,2	32,0
PW615F	SEL	A	300,0	85,5	81,7	78,7	75,3	69,5	62,8	58,0	52,7	46,9	41,1
PW615F	SEL	A	500,0	87,0	82,9	79,8	76,3	70,4	63,8	59,0	53,9	48,3	42,6
PW615F	SEL	D	700,0	89,6	85,7	82,6	79,0	73,0	65,9	60,8	55,2	49,1	42,8
PW615F	SEL	D	900,0	92,9	89,0	86,0	82,5	76,5	69,6	64,6	59,2	53,2	47,1
PW615F	SEL	D	1 100,0	95,6	92,0	89,1	85,7	79,8	73,0	68,0	62,5	56,5	50,4

NPD_ID	Noise metric	Op type	Power setting (the 'Power Parameter' field in the 'Aircraft' table specifies the power setting type and unit)	L_200ft	L_400ft	L_630ft	L_1000ft	L_2000ft	L_4000ft	L_6300ft	L_10000ft	L_16000ft	L_25000ft
PW615F	SEL	D	1 300,0	97,4	94,1	91,3	88,1	82,4	75,7	70,8	65,4	59,4	53,3
RAISQP	LAmx	A	23,0	77,2	70,0	65,1	59,9	51,5	42,3	36,2	30,0	23,6	17,9
RAISQP	LAmx	A	30,0	78,3	71,3	67,4	61,7	53,9	45,6	39,8	33,6	27,0	20,1
RAISQP	LAmx	D	60,0	84,7	78,1	73,6	68,9	61,5	53,8	48,4	42,6	36,3	29,8
RAISQP	LAmx	D	85,0	89,2	82,7	78,4	74,0	67,2	60,1	55,3	50,2	44,6	38,7
RAISQP	LAmx	D	100,0	96,8	90,5	86,3	82,1	75,4	68,3	63,3	57,7	51,3	44,6
RAISQP	SEL	A	23,0	82,3	77,9	74,7	71,4	65,5	59,2	54,8	50,1	45,6	41,3
RAISQP	SEL	A	30,0	82,6	78,6	76,3	72,7	67,6	61,8	57,6	52,9	48,2	43,9
RAISQP	SEL	D	60,0	87,6	84,1	81,6	78,8	74,1	68,8	65,0	60,8	56,1	51,4
RAISQP	SEL	D	85,0	92,3	88,6	86,1	83,4	79,2	74,7	71,3	68,0	63,9	60,1
RAISQP	SEL	D	100,0	97,8	94,5	92,3	90,0	86,3	82,0	78,9	75,2	70,9	66,0
RB183	LAmx	A	1 798,0	94,7	87,6	82,6	77,6	69,3	60,8	54,7	47,4	38,9	29,9
RB183	LAmx	A	2 698,0	95,6	89,1	84,5	79,8	72,3	64,0	57,9	50,6	42,0	32,9
RB183	LAmx	A	3 147,0	98,1	91,3	86,4	81,6	74,2	65,6	59,5	52,2	43,7	34,8
RB183	LAmx	A	3 597,0	98,7	92,2	87,3	82,6	75,6	67,2	61,1	53,8	45,3	36,3
RB183	LAmx	A	4 496,0	100,4	94,3	90,1	85,4	78,8	70,4	64,3	57,0	48,5	39,5
RB183	LAmx	D	4 496,0	101,6	95,0	90,6	85,8	78,6	70,9	65,2	58,5	50,0	39,6
RB183	LAmx	D	10 116,0	119,8	113,4	108,9	104,2	96,9	89,3	83,5	76,9	68,4	58,0
RB183	SEL	A	1 798,0	96,5	91,7	88,2	84,8	78,8	72,6	68,1	62,3	55,4	47,9
RB183	SEL	A	2 698,0	97,4	93,2	90,1	87,0	81,8	75,8	71,3	65,5	58,5	50,9
RB183	SEL	A	3 147,0	99,9	95,4	92,0	88,8	83,7	77,4	72,9	67,1	60,2	52,8

NPD_ID	Noise metric	Op type	Power setting (the 'Power Parameter' field in the 'Aircraft' table specifies the power setting type and unit)	L_200ft	L_400ft	L_630ft	L_1000ft	L_2000ft	L_4000ft	L_6300ft	L_10000ft	L_16000ft	L_25000ft
RB183	SEL	A	3 597,0	100,5	96,3	92,9	89,8	85,1	79,0	74,5	68,7	61,8	54,3
RB183	SEL	A	4 496,0	102,2	98,4	95,7	92,6	88,3	82,2	77,7	71,9	65,0	57,5
RB183	SEL	D	4 496,0	103,4	99,1	96,2	93,0	88,1	82,7	78,6	73,4	66,5	57,6
RB183	SEL	D	10 116,0	121,6	117,5	114,5	111,4	106,4	101,1	96,9	91,8	84,9	76,0
RB183P	LAmx	A	1 798,0	93,7	86,9	82,3	77,3	69,1	60,6	54,2	46,5	37,4	27,6
RB183P	LAmx	A	2 698,0	94,0	87,9	83,8	79,5	72,0	63,5	57,0	49,3	40,2	30,5
RB183P	LAmx	A	3 147,0	97,0	90,5	85,9	81,3	73,7	64,9	58,5	50,8	41,9	32,4
RB183P	LAmx	A	3 597,0	97,8	91,5	87,2	82,5	74,9	66,4	59,9	52,2	43,3	33,7
RB183P	LAmx	A	4 496,0	99,9	93,8	89,6	85,3	77,8	69,3	62,8	55,1	46,1	36,4
RB183P	LAmx	D	4 496,0	101,5	94,6	89,9	84,9	77,4	69,3	63,3	56,3	47,5	36,5
RB183P	LAmx	D	10 116,0	116,3	109,6	104,9	100,1	92,5	84,4	78,4	71,4	62,5	51,5
RB183P	SEL	A	1 798,0	95,5	91,0	87,9	84,5	78,6	72,4	67,6	61,4	53,9	45,6
RB183P	SEL	A	2 698,0	95,8	92,0	89,4	86,7	81,5	75,3	70,4	64,2	56,7	48,5
RB183P	SEL	A	3 147,0	98,8	94,6	91,5	88,5	83,2	76,7	71,9	65,7	58,4	50,4
RB183P	SEL	A	3 597,0	99,6	95,6	92,8	89,7	84,4	78,2	73,3	67,1	59,8	51,7
RB183P	SEL	A	4 496,0	101,7	97,9	95,2	92,5	87,3	81,1	76,2	70,0	62,6	54,4
RB183P	SEL	D	4 496,0	103,3	98,7	95,5	92,1	86,9	81,1	76,7	71,2	64,0	54,5
RB183P	SEL	D	10 116,0	118,1	113,7	110,5	107,3	102,0	96,2	91,8	86,3	79,0	69,5
RB2112	LAmx	A	8 000,0	99,2	92,0	86,6	81,0	72,1	63,0	56,5	49,1	40,8	32,5
RB2112	LAmx	A	14 000,0	102,8	95,8	90,7	85,3	76,8	67,9	61,5	54,2	46,1	38,1

NPD_ID	Noise metric	Op type	Power setting (the 'Power Parameter' field in the 'Aircraft' table specifies the power setting type and unit)	L_200ft	L_400ft	L_630ft	L_1000ft	L_2000ft	L_4000ft	L_6300ft	L_10000ft	L_16000ft	L_25000ft
RB2112	LAmx	D	20 000,0	104,8	97,4	93,0	87,8	79,6	70,7	64,4	57,2	49,2	41,4
RB2112	LAmx	D	28 000,0	106,7	99,9	95,1	90,0	82,0	73,2	66,9	59,8	51,9	44,1
RB2112	LAmx	D	36 000,0	108,3	101,6	97,0	92,0	84,2	75,4	69,2	62,2	54,3	46,7
RB2112	SEL	A	8 000,0	100,7	95,5	91,7	87,5	81,1	74,0	68,8	63,0	56,3	49,7
RB2112	SEL	A	14 000,0	104,8	100,0	96,4	92,5	86,4	79,5	74,5	68,8	62,3	55,8
RB2112	SEL	D	20 000,0	107,3	102,6	99,1	95,5	89,5	82,8	77,8	72,3	65,8	59,5
RB2112	SEL	D	28 000,0	109,8	105,3	101,9	98,5	92,7	86,1	81,2	75,8	69,5	63,2
RB2112	SEL	D	36 000,0	111,4	107,1	103,8	100,5	94,8	88,3	83,5	78,1	71,9	65,6
RDA532	LAmx	A	32,0	96,4	88,7	82,9	76,2	65,3	55,1	48,3	41,3	34,1	26,4
RDA532	LAmx	A	73,0	98,2	91,1	86,2	81,2	73,6	65,9	60,5	54,7	48,2	40,7
RDA532	LAmx	D	73,0	98,2	91,1	86,2	81,2	73,6	65,9	60,5	54,7	48,2	40,7
RDA532	LAmx	D	100,0	98,6	92,2	87,8	83,4	76,4	68,9	63,4	57,3	50,3	42,0
RDA532	SEL	A	32,0	98,9	93,5	89,1	84,0	75,3	67,3	62,0	56,5	50,8	44,6
RDA532	SEL	A	73,0	100,2	95,4	92,0	88,4	83,1	77,7	73,8	69,5	64,5	58,5
RDA532	SEL	D	73,0	100,2	95,4	92,0	88,4	83,1	77,7	73,8	69,5	64,5	58,5
RDA532	SEL	D	100,0	101,3	97,2	94,3	91,4	86,7	81,4	77,5	72,8	67,3	60,6
RR535E	LAmx	A	6 000,0	91,9	84,7	80,1	75,2	67,4	58,6	52,1	45,1	38,1	31,4
RR535E	LAmx	A	7 000,0	92,0	84,9	80,3	75,4	67,6	58,8	52,4	45,4	38,4	31,8
RR535E	LAmx	A	8 000,0	92,2	85,2	80,6	75,6	67,8	59,0	52,7	45,8	38,8	32,2
RR535E	LAmx	A	9 000,0	92,5	85,5	80,8	75,9	68,0	59,3	53,0	46,2	39,2	32,7

NPD_ID	Noise metric	Op type	Power setting (the 'Power Parameter' field in the 'Aircraft' table specifies the power setting type and unit)	L_200ft	L_400ft	L_630ft	L_1000ft	L_2000ft	L_4000ft	L_6300ft	L_10000ft	L_16000ft	L_25000ft
RR535E	LAmx	D	10 000,0	91,0	84,0	79,7	75,1	67,5	59,1	53,0	46,3	39,4	33,0
RR535E	LAmx	D	15 000,0	95,7	87,9	83,1	78,4	70,8	62,3	56,3	49,8	43,1	36,8
RR535E	LAmx	D	20 000,0	99,1	91,1	86,3	81,5	73,8	65,4	59,5	53,0	46,4	40,1
RR535E	LAmx	D	25 000,0	101,6	93,9	89,1	84,3	76,7	68,3	62,4	55,9	49,2	43,0
RR535E	LAmx	D	30 000,0	103,7	96,5	91,9	87,2	79,6	71,2	65,3	58,7	52,0	45,8
RR535E	LAmx	D	35 000,0	106,2	100,3	96,1	91,6	84,1	75,8	69,7	63,0	56,2	49,9
RR535E	SEL	A	6 000,0	95,9	90,9	87,8	84,6	79,2	72,9	68,1	62,9	57,6	52,5
RR535E	SEL	A	7 000,0	95,8	91,0	88,0	84,7	79,3	73,1	68,4	63,2	58,0	53,0
RR535E	SEL	A	8 000,0	95,9	91,2	88,2	84,9	79,6	73,4	68,7	63,6	58,4	53,5
RR535E	SEL	A	9 000,0	96,0	91,5	88,5	85,2	79,8	73,7	69,1	64,0	58,9	54,1
RR535E	SEL	D	10 000,0	93,9	89,5	86,4	83,5	78,3	72,4	68,0	63,0	57,9	53,2
RR535E	SEL	D	15 000,0	98,4	93,9	90,7	87,5	82,1	76,1	71,8	67,0	62,1	57,6
RR535E	SEL	D	20 000,0	101,6	97,1	94,0	90,8	85,4	79,4	75,1	70,4	65,7	61,2
RR535E	SEL	D	25 000,0	104,0	99,7	96,6	93,5	88,2	82,3	78,1	73,5	68,8	64,4
RR535E	SEL	D	30 000,0	106,0	101,8	98,8	95,9	90,8	85,1	81,0	76,5	71,8	67,5
RR535E	SEL	D	35 000,0	108,3	104,5	101,8	99,4	94,6	89,4	85,4	80,9	76,2	71,9
SPEYHK	LAmx	A	1 000,0	86,5	80,4	76,1	71,5	64,1	56,3	50,8	45,0	38,9	32,8
SPEYHK	LAmx	A	2 000,0	90,6	84,5	80,2	75,6	68,2	60,4	54,9	49,1	43,0	36,9
SPEYHK	LAmx	A	4 000,0	98,8	92,7	88,4	83,8	76,4	68,6	63,1	57,3	51,2	45,1
SPEYHK	LAmx	A	6 000,0	108,7	102,6	98,3	93,7	86,3	78,5	73,0	67,2	61,1	55,0

NPD_ID	Noise metric	Op type	Power setting (the 'Power Parameter' field in the 'Aircraft' table specifies the power setting type and unit)	L_200ft	L_400ft	L_630ft	L_1000ft	L_2000ft	L_4000ft	L_6300ft	L_10000ft	L_16000ft	L_25000ft
SPEYHK	LAmx	A	8 000,0	113,5	107,4	103,1	98,5	91,1	83,3	77,8	72,0	65,9	59,8
SPEYHK	LAmx	A	10 000,0	119,4	113,3	109,0	104,4	97,0	89,2	83,7	77,9	71,8	65,7
SPEYHK	LAmx	D	1 000,0	86,5	80,4	76,1	71,5	64,1	56,3	50,8	45,0	38,9	32,8
SPEYHK	LAmx	D	2 000,0	90,6	84,5	80,2	75,6	68,2	60,4	54,9	49,1	43,0	36,9
SPEYHK	LAmx	D	4 000,0	98,8	92,7	88,4	83,8	76,4	68,6	63,1	57,3	51,2	45,1
SPEYHK	LAmx	D	6 000,0	108,7	102,6	98,3	93,7	86,3	78,5	73,0	67,2	61,1	55,0
SPEYHK	LAmx	D	8 000,0	113,5	107,4	103,1	98,5	91,1	83,3	77,8	72,0	65,9	59,8
SPEYHK	LAmx	D	10 000,0	119,4	113,3	109,0	104,4	97,0	89,2	83,7	77,9	71,8	65,7
SPEYHK	SEL	A	1 000,0	89,4	85,5	82,5	79,1	73,3	66,8	62,1	56,9	51,3	45,6
SPEYHK	SEL	A	2 000,0	93,5	89,6	86,6	83,2	77,4	70,9	66,2	61,0	55,4	49,7
SPEYHK	SEL	A	4 000,0	101,7	97,8	94,8	91,4	85,6	79,1	74,4	69,2	63,6	57,9
SPEYHK	SEL	A	6 000,0	111,8	107,9	104,9	101,5	95,7	89,2	84,5	79,3	73,7	68,0
SPEYHK	SEL	A	8 000,0	117,3	113,4	110,4	107,0	101,2	94,7	90,0	84,8	79,2	73,5
SPEYHK	SEL	A	10 000,0	123,9	120,0	117,0	113,6	107,8	101,3	96,6	91,4	85,8	80,1
SPEYHK	SEL	D	1 000,0	89,4	85,5	82,5	79,1	73,3	66,8	62,1	56,9	51,3	45,6
SPEYHK	SEL	D	2 000,0	93,5	89,6	86,6	83,2	77,4	70,9	66,2	61,0	55,4	49,7
SPEYHK	SEL	D	4 000,0	101,7	97,8	94,8	91,4	85,6	79,1	74,4	69,2	63,6	57,9
SPEYHK	SEL	D	6 000,0	111,8	107,9	104,9	101,5	95,7	89,2	84,5	79,3	73,7	68,0
SPEYHK	SEL	D	8 000,0	117,3	113,4	110,4	107,0	101,2	94,7	90,0	84,8	79,2	73,5
SPEYHK	SEL	D	10 000,0	123,9	120,0	117,0	113,6	107,8	101,3	96,6	91,4	85,8	80,1

NPD_ID	Noise metric	Op type	Power setting (the 'Power Parameter' field in the 'Aircraft' table specifies the power setting type and unit)	L_200ft	L_400ft	L_630ft	L_1000ft	L_2000ft	L_4000ft	L_6300ft	L_10000ft	L_16000ft	L_25000ft
T1KBFP	LAmx	A	5 250,0	92,3	85,1	80,3	75,4	67,4	58,8	52,6	45,9	39,1	32,7
T1KBFP	LAmx	A	10 500,0	92,7	85,5	80,7	75,7	67,8	59,2	53,0	46,3	39,6	33,3
T1KBFP	LAmx	A	15 750,0	93,6	86,4	81,5	76,5	68,6	60,0	53,9	47,2	40,5	34,3
T1KBFP	LAmx	A	21 000,0	94,6	87,4	82,5	77,5	69,5	61,0	54,9	48,3	41,7	35,5
T1KBFP	LAmx	D	20 000,0	92,9	85,9	81,3	76,4	68,5	60,0	53,9	47,0	40,1	33,6
T1KBFP	LAmx	D	29 000,0	94,8	88,0	83,3	78,2	70,1	61,4	55,2	48,5	41,7	35,4
T1KBFP	LAmx	D	38 000,0	97,1	90,2	85,7	80,4	72,3	63,5	57,3	50,7	44,0	37,8
T1KBFP	LAmx	D	47 000,0	99,5	92,5	88,2	82,8	74,6	65,9	59,8	53,2	46,6	40,4
T1KBFP	LAmx	D	56 000,0	101,9	94,8	90,8	85,1	77,0	68,4	62,4	55,9	49,3	43,2
T1KBFP	LAmx	D	65 000,0	105,2	97,8	94,2	88,3	80,3	71,9	66,0	59,6	53,2	47,2
T1KBFP	SEL	A	5 250,0	94,9	90,5	87,4	84,3	79,1	73,1	68,5	63,4	58,3	53,5
T1KBFP	SEL	A	10 500,0	95,9	91,3	88,2	84,9	79,4	73,3	68,7	63,7	58,6	53,9
T1KBFP	SEL	A	15 750,0	97,1	92,5	89,2	85,8	80,2	74,1	69,6	64,7	59,6	55,0
T1KBFP	SEL	A	21 000,0	98,4	93,7	90,2	86,8	81,2	75,2	70,8	65,9	61,0	56,4
T1KBFP	SEL	D	20 000,0	96,4	91,8	88,6	84,8	79,1	73,0	68,5	63,5	58,4	53,6
T1KBFP	SEL	D	29 000,0	97,1	92,7	90,0	86,1	80,5	74,5	70,1	65,2	60,3	55,8
T1KBFP	SEL	D	38 000,0	98,6	94,3	91,8	87,9	82,4	76,6	72,3	67,5	62,8	58,4
T1KBFP	SEL	D	47 000,0	100,5	96,2	94,0	89,9	84,7	78,9	74,8	70,1	65,5	61,2
T1KBFP	SEL	D	56 000,0	102,5	98,3	96,2	92,1	87,0	81,5	77,4	72,9	68,3	64,1
T1KBFP	SEL	D	65 000,0	105,4	101,2	99,3	95,1	90,2	84,9	81,0	76,6	72,2	68,2

NPD_ID	Noise metric	Op type	Power setting (the 'Power Parameter' field in the 'Aircraft' table specifies the power setting type and unit)	L_200ft	L_400ft	L_630ft	L_1000ft	L_2000ft	L_4000ft	L_6300ft	L_10000ft	L_16000ft	L_25000ft
T56A7	LAmx	A	30,0	96,0	89,4	84,8	79,9	71,9	62,4	55,0	47,0	39,2	31,6
T56A7	LAmx	A	100,0	99,8	93,3	88,9	84,3	77,3	70,0	65,1	60,0	54,5	48,4
T56A7	LAmx	D	30,0	96,0	89,4	84,8	79,9	71,9	62,4	55,0	47,0	39,2	31,6
T56A7	LAmx	D	100,0	99,8	93,3	88,9	84,3	77,3	70,0	65,1	60,0	54,5	48,4
T56A7	SEL	A	30,0	98,0	93,7	90,6	87,2	81,4	74,2	68,3	61,8	55,5	49,4
T56A7	SEL	A	100,0	100,1	95,8	92,9	89,8	85,0	80,0	76,6	72,9	69,0	64,4
T56A7	SEL	D	30,0	98,0	93,7	90,6	87,2	81,4	74,2	68,3	61,8	55,5	49,4
T56A7	SEL	D	100,0	100,1	95,8	92,9	89,8	85,0	80,0	76,6	72,9	69,0	64,4
TAY620	LAmx	A	3 372,0	89,1	82,7	78,4	73,9	66,8	58,9	53,1	46,9	40,4	34,3
TAY620	LAmx	A	5 620,0	93,0	86,8	82,6	78,0	70,7	62,6	56,8	50,3	43,6	37,2
TAY620	LAmx	D	4 496,0	91,5	85,3	81,0	76,1	68,7	60,2	54,3	48,0	41,4	35,7
TAY620	LAmx	D	13 489,0	106,2	100,2	96,1	91,5	84,4	76,4	70,3	63,6	56,4	50,3
TAY620	SEL	A	3 372,0	90,9	86,8	84,0	81,1	76,3	70,7	66,5	61,8	56,9	52,3
TAY620	SEL	A	5 620,0	94,8	90,9	88,2	85,2	80,2	74,4	70,2	65,2	60,1	55,2
TAY620	SEL	D	4 496,0	93,3	89,4	86,6	83,3	78,2	72,0	67,7	62,9	57,9	53,7
TAY620	SEL	D	13 489,0	108,0	104,3	101,7	98,7	93,9	88,2	83,7	78,5	72,9	68,3
TAY650	LAmx	A	3 372,0	89,3	82,9	78,6	74,0	66,7	58,8	53,1	46,9	40,4	34,3
TAY650	LAmx	A	5 620,0	92,3	86,0	81,7	77,1	69,7	61,7	56,0	49,8	43,3	37,2
TAY650	LAmx	D	4 496,0	91,3	84,8	80,2	75,0	67,3	58,6	53,0	47,2	41,1	35,8
TAY650	LAmx	D	13 488,0	104,7	98,8	94,6	90,2	83,2	75,5	69,8	63,6	57,1	51,5

NPD_ID	Noise metric	Op type	Power setting (the 'Power Parameter' field in the 'Aircraft' table specifies the power setting type and unit)	L_200ft	L_400ft	L_630ft	L_1000ft	L_2000ft	L_4000ft	L_6300ft	L_10000ft	L_16000ft	L_25000ft
TAY650	SEL	A	3 372,0	91,1	87,0	84,2	81,2	76,2	70,6	66,5	61,8	56,9	52,3
TAY650	SEL	A	5 620,0	94,1	90,1	87,3	84,3	79,2	73,5	69,4	64,7	59,8	55,2
TAY650	SEL	D	4 496,0	93,1	88,9	85,8	82,2	76,8	70,4	66,4	62,1	57,6	53,8
TAY650	SEL	D	13 488,0	106,5	102,9	100,2	97,4	92,7	87,3	83,2	78,5	73,6	69,5
TAY651	LAmx	A	5 000,0	91,4	84,7	80,1	75,3	67,7	59,5	53,7	47,3	40,8	34,6
TAY651	LAmx	A	7 000,0	97,9	91,2	86,7	82,0	74,4	66,0	60,1	53,4	46,6	40,1
TAY651	LAmx	D	9 000,0	101,2	94,6	90,1	85,4	77,8	69,4	63,3	56,6	49,8	43,3
TAY651	LAmx	D	11 000,0	104,0	97,4	92,9	88,2	80,6	72,2	66,2	59,4	52,5	45,9
TAY651	LAmx	D	13 000,0	108,4	101,8	97,4	92,7	85,1	76,8	70,8	64,4	57,9	51,7
TAY651	SEL	A	5 000,0	95,7	91,1	87,8	84,4	79,0	73,0	68,7	63,7	58,6	53,8
TAY651	SEL	A	7 000,0	100,5	96,1	93,1	89,8	84,5	78,4	73,9	68,7	63,4	58,4
TAY651	SEL	D	9 000,0	103,5	99,1	96,2	92,9	87,6	81,5	76,9	71,7	66,4	61,3
TAY651	SEL	D	11 000,0	106,3	101,9	98,9	95,7	90,4	84,3	79,7	74,3	68,8	63,6
TAY651	SEL	D	13 000,0	110,2	105,9	102,9	99,7	94,4	88,3	83,8	78,7	73,5	68,6
TAYGIV	LAmx	A	2 000,0	86,0	79,9	75,6	71,0	63,7	55,8	50,3	44,5	38,4	32,4
TAYGIV	LAmx	A	3 000,0	87,2	81,1	76,8	72,2	64,8	57,0	51,5	45,7	39,6	33,5
TAYGIV	LAmx	A	4 000,0	88,5	82,4	78,1	73,5	66,2	58,3	52,8	47,0	40,9	34,9
TAYGIV	LAmx	A	6 000,0	91,5	85,4	81,1	76,5	69,2	61,3	55,8	50,0	43,9	37,9
TAYGIV	LAmx	A	8 000,0	95,1	88,9	84,7	80,0	72,7	64,8	59,4	53,6	47,4	41,4
TAYGIV	LAmx	A	10 000,0	99,1	93,0	88,7	84,1	76,7	68,9	63,4	57,6	51,5	45,4

NPD_ID	Noise metric	Op type	Power setting (the 'Power Parameter' field in the 'Aircraft' table specifies the power setting type and unit)	L_200ft	L_400ft	L_630ft	L_1000ft	L_2000ft	L_4000ft	L_6300ft	L_10000ft	L_20000ft	L_40000ft	L_63000ft	L_100000ft	L_160000ft	L_250000ft
TAYGIV	LAmx	D	2 000,0	86,0	79,9	75,6	71,0	63,7	55,8	50,3	44,5	38,4	32,4				
TAYGIV	LAmx	D	3 000,0	87,2	81,1	76,8	72,2	64,8	57,0	51,5	45,7	39,6	33,5				
TAYGIV	LAmx	D	4 000,0	88,5	82,4	78,1	73,5	66,2	58,3	52,8	47,0	40,9	34,9				
TAYGIV	LAmx	D	6 000,0	91,5	85,4	81,1	76,5	69,2	61,3	55,8	50,0	43,9	37,9				
TAYGIV	LAmx	D	8 000,0	95,1	88,9	84,7	80,0	72,7	64,8	59,4	53,6	47,4	41,4				
TAYGIV	LAmx	D	10 000,0	99,1	93,0	88,7	84,1	76,7	68,9	63,4	57,6	51,5	45,4				
TAYGIV	LAmx	D	11 000,0	101,0	95,0	91,0	86,0	79,0	71,0	65,5	60,0	54,0	47,5				
TAYGIV	LAmx	D	11 200,0	101,5	95,5	91,5	86,5	79,5	71,5	66,0	60,5	54,5	48,0				
TAYGIV	SEL	A	2 000,0	89,9	86,0	83,0	79,6	73,9	67,3	62,6	57,4	51,8	46,2				
TAYGIV	SEL	A	3 000,0	90,7	86,8	83,8	80,4	74,6	68,0	63,3	58,2	52,6	46,9				
TAYGIV	SEL	A	4 000,0	91,6	87,7	84,7	81,3	75,5	69,0	64,2	59,1	53,5	47,8				
TAYGIV	SEL	A	6 000,0	93,9	90,0	87,0	83,6	77,8	71,3	66,5	61,4	55,8	50,1				
TAYGIV	SEL	A	8 000,0	96,8	92,9	89,9	86,5	80,8	74,2	69,5	64,3	58,7	53,1				
TAYGIV	SEL	A	10 000,0	100,4	96,5	93,5	90,1	84,4	77,8	73,1	67,9	62,3	56,6				
TAYGIV	SEL	D	2 000,0	89,9	86,0	83,0	79,6	73,9	67,3	62,6	57,4	51,8	46,2				
TAYGIV	SEL	D	3 000,0	90,7	86,8	83,8	80,4	74,6	68,0	63,3	58,2	52,6	46,9				
TAYGIV	SEL	D	4 000,0	91,6	87,7	84,7	81,3	75,5	69,0	64,2	59,1	53,5	47,8				
TAYGIV	SEL	D	6 000,0	93,9	90,0	87,0	83,6	77,8	71,3	66,5	61,4	55,8	50,1				
TAYGIV	SEL	D	8 000,0	96,8	92,9	89,9	86,5	80,8	74,2	69,5	64,3	58,7	53,1				
TAYGIV	SEL	D	10 000,0	100,4	96,5	93,5	90,1	84,4	77,8	73,1	67,9	62,3	56,6				
TAYGIV	SEL	D	2 000,0	89,9	86,0	83,0	79,6	73,9	67,3	62,6	57,4	51,8	46,2				
TAYGIV	SEL	D	3 000,0	90,7	86,8	83,8	80,4	74,6	68,0	63,3	58,2	52,6	46,9				
TAYGIV	SEL	D	4 000,0	91,6	87,7	84,7	81,3	75,5	69,0	64,2	59,1	53,5	47,8				
TAYGIV	SEL	D	6 000,0	93,9	90,0	87,0	83,6	77,8	71,3	66,5	61,4	55,8	50,1				
TAYGIV	SEL	D	8 000,0	96,8	92,9	89,9	86,5	80,8	74,2	69,5	64,3	58,7	53,1				
TAYGIV	SEL	D	10 000,0	100,4	96,5	93,5	90,1	84,4	77,8	73,1	67,9	62,3	56,6				

NPD_ID	Noise metric	Op type	Power setting (the 'Power Parameter' field in the 'Aircraft' table specifies the power setting type and unit)	L_200ft	L_400ft	L_630ft	L_1000ft	L_2000ft	L_4000ft	L_6300ft	L_10000ft	L_16000ft	L_25000ft
TAYGIV	SEL	D	11 000,0	102,0	98,0	95,5	92,0	86,0	79,5	74,5	70,0	64,0	58,5
TAYGIV	SEL	D	11 200,0	102,5	98,5	96,0	92,5	86,5	80,0	75,0	70,5	64,5	59,0
TF7312	LAmx	A	1 000,0	91,1	84,2	79,2	73,9	65,5	56,6	50,2	43,5	36,3	28,6
TF7312	LAmx	A	1 500,0	96,1	89,3	84,4	79,3	71,0	61,9	55,2	48,0	40,1	31,6
TF7312	LAmx	D	1 500,0	96,1	89,3	84,4	79,3	71,0	61,9	55,2	48,0	40,1	31,6
TF7312	LAmx	D	2 650,0	107,5	99,8	94,4	88,9	80,1	70,3	62,9	54,6	45,3	35,0
TF7312	SEL	A	1 000,0	93,7	89,0	85,6	81,8	75,6	68,9	64,1	58,8	53,1	46,9
TF7312	SEL	A	1 500,0	99,3	94,8	91,4	87,8	81,8	74,9	69,7	64,0	57,6	50,6
TF7312	SEL	D	1 500,0	99,3	94,8	91,4	87,8	81,8	74,9	69,7	64,0	57,6	50,6
TF7312	SEL	D	2 650,0	110,5	105,0	101,1	97,1	90,6	83,0	77,1	70,3	62,5	53,8
TF7313	LAmx	A	880,0	85,8	78,6	73,4	67,9	59,1	50,0	43,6	36,6	28,8	20,7
TF7313	LAmx	A	2 300,0	95,2	88,6	84,1	79,3	71,7	63,4	57,3	50,1	41,6	32,2
TF7313	LAmx	D	2 300,0	95,2	88,6	84,1	79,3	71,7	63,4	57,3	50,1	41,6	32,2
TF7313	LAmx	D	3 000,0	101,0	94,4	89,8	85,0	77,4	69,1	63,0	55,9	47,6	38,6
TF7313	SEL	A	880,0	87,1	82,9	79,8	76,4	70,8	64,3	59,3	53,8	47,6	41,0
TF7313	SEL	A	2 300,0	95,9	92,0	89,3	86,3	81,3	75,4	70,8	65,1	58,1	50,2
TF7313	SEL	D	2 300,0	95,9	92,0	89,3	86,3	81,3	75,4	70,8	65,1	58,1	50,2
TF7313	SEL	D	3 000,0	103,4	99,4	96,4	93,8	88,8	82,9	78,3	72,7	65,9	58,3
TIO540	LAmx	A	1 900,0	77,7	70,8	65,6	61,2	54,5	47,5	42,6	37,3	31,4	25,3
TIO540	LAmx	A	2 300,0	83,6	77,1	72,7	68,1	60,9	53,4	48,1	42,5	36,3	29,8

NPD_ID	Noise metric	Op type	Power setting (the 'Power Parameter' field in the 'Aircraft' table specifies the power setting type and unit)	L_200ft	L_400ft	L_630ft	L_1000ft	L_2000ft	L_4000ft	L_6300ft	L_10000ft	L_16000ft	L_25000ft
TIO540	LAmx	D	2 400,0	85,2	78,7	74,4	69,9	62,8	55,5	50,4	45,0	39,0	32,7
TIO540	LAmx	D	2 500,0	89,5	83,1	78,8	74,3	67,3	60,1	55,1	49,7	43,7	37,4
TIO540	SEL	A	1 900,0	78,6	74,8	72,3	69,7	65,9	61,7	58,6	55,1	50,9	46,4
TIO540	SEL	A	2 300,0	84,3	80,8	78,4	75,9	71,8	67,3	64,0	60,3	55,7	50,6
TIO540	SEL	D	2 400,0	86,0	82,5	80,1	77,5	73,5	69,0	65,7	62,1	57,7	52,9
TIO540	SEL	D	2 500,0	88,9	85,4	82,9	80,4	76,4	72,0	68,8	65,2	61,0	56,2
TIO542	LAmx	A	2 380,0	85,1	78,8	74,6	70,2	63,4	56,2	51,1	45,4	39,2	32,5
TIO542	LAmx	A	2 400,0	86,8	80,5	76,3	71,9	65,0	57,6	52,3	46,5	40,1	33,4
TIO542	LAmx	D	2 190,0	85,9	79,4	75,0	70,5	63,4	56,0	51,0	45,6	39,7	33,6
TIO542	LAmx	D	2 280,0	88,2	81,7	77,4	72,8	65,7	58,1	53,0	47,4	41,4	35,0
TIO542	LAmx	D	2 500,0	92,1	85,7	81,3	76,7	69,4	61,7	56,2	50,3	43,8	37,0
TIO542	SEL	A	2 380,0	85,2	81,6	79,3	76,8	72,9	68,4	65,2	61,5	57,1	52,4
TIO542	SEL	A	2 400,0	86,8	83,2	80,9	78,4	74,3	69,8	66,4	62,5	58,0	53,2
TIO542	SEL	D	2 190,0	87,8	84,1	81,6	78,8	74,4	69,5	66,0	62,1	57,9	53,3
TIO542	SEL	D	2 280,0	89,5	85,6	82,9	80,2	75,7	70,9	67,4	63,5	59,1	54,3
TIO542	SEL	D	2 500,0	93,1	89,4	87,0	84,3	80,0	75,0	71,4	67,3	62,4	57,2
TPE331	LAmx	A	30,0	83,9	77,6	73,4	69,0	62,1	54,6	49,0	42,8	35,6	27,0
TPE331	LAmx	A	100,0	88,4	82,3	78,2	74,0	67,5	60,5	55,4	49,8	43,5	36,4
TPE331	LAmx	D	30,0	83,9	77,6	73,4	69,0	62,1	54,6	49,0	42,8	35,6	27,0
TPE331	LAmx	D	100,0	88,4	82,3	78,2	74,0	67,5	60,5	55,4	49,8	43,5	36,4

NPD_ID	Noise metric	Op type	Power setting (the 'Power Parameter' field in the 'Aircraft' table specifies the power setting type and unit)	L_200ft	L_400ft	L_630ft	L_1000ft	L_2000ft	L_4000ft	L_6300ft	L_10000ft	L_16000ft	L_25000ft
TPE331	SEL	A	30,0	84,3	80,2	77,4	74,6	69,9	64,7	60,6	55,9	50,2	43,7
TPE331	SEL	A	100,0	88,5	84,6	82,0	79,3	75,0	70,3	66,7	62,7	57,9	52,2
TPE331	SEL	D	30,0	84,3	80,2	77,4	74,6	69,9	64,7	60,6	55,9	50,2	43,7
TPE331	SEL	D	100,0	88,5	84,6	82,0	79,3	75,0	70,3	66,7	62,7	57,9	52,2
TPE331-5	LAmx	A	300,0	85,5	78,8	74,3	69,5	61,8	53,5	47,6	41,1	33,7	26,0
TPE331-5	LAmx	A	306,0	85,5	78,8	74,3	69,5	61,8	53,5	47,6	41,1	33,7	26,0
TPE331-5	LAmx	A	460,0	84,2	77,5	73,0	68,2	60,5	52,2	46,2	39,5	32,1	24,5
TPE331-5	LAmx	D	1 491,0	86,9	80,5	76,1	71,5	64,3	56,6	51,1	45,3	39,1	32,9
TPE331-5	LAmx	D	1 791,0	88,1	81,6	77,2	72,6	65,3	57,3	51,5	45,2	38,4	31,5
TPE331-5	LAmx	D	1 800,0	88,1	81,6	77,2	72,6	65,3	57,3	51,5	45,2	38,4	31,5
TPE331-5	SEL	A	300,0	88,5	84,1	81,1	77,8	72,4	66,4	61,9	56,9	51,0	44,8
TPE331-5	SEL	A	306,0	88,5	84,1	81,1	77,8	72,4	66,4	61,9	56,9	51,0	44,8
TPE331-5	SEL	A	460,0	86,7	82,3	79,3	76,0	70,6	64,5	59,9	54,8	48,9	42,7
TPE331-5	SEL	D	1 491,0	89,7	85,5	82,6	79,6	74,6	69,1	65,1	60,8	56,2	51,4
TPE331-5	SEL	D	1 791,0	89,9	85,7	82,8	79,7	74,6	68,9	64,6	59,8	54,5	49,1
TPE331-5	SEL	D	1 800,0	89,9	85,7	82,8	79,7	74,6	68,9	64,6	59,8	54,5	49,1
TRENT5	LAmx	A	3 000,0	94,6	88,1	83,3	78,3	70,5	61,8	55,6	48,7	41,1	33,2
TRENT5	LAmx	A	5 000,0	95,6	88,8	84,0	78,9	70,9	62,1	55,8	48,9	41,2	33,3
TRENT5	LAmx	A	7 000,0	96,2	89,6	84,6	79,5	71,3	62,6	56,3	49,3	41,7	33,9
TRENT5	LAmx	A	9 000,0	97,2	90,7	85,7	80,5	72,2	63,2	56,8	49,8	42,1	34,1

NPD_ID	Noise metric	Op type	Power setting (the 'Power Parameter' field in the 'Aircraft' table specifies the power setting type and unit)	L_200ft	L_400ft	L_630ft	L_1000ft	L_2000ft	L_4000ft	L_6300ft	L_10000ft	L_16000ft	L_25000ft
TRENT5	LAmx	D	30 000,0	104,0	96,3	91,0	85,5	77,0	67,8	61,1	53,8	45,9	37,8
TRENT5	LAmx	D	35 000,0	104,8	97,3	92,2	86,9	78,6	69,5	62,8	55,7	47,8	39,7
TRENT5	LAmx	D	40 000,0	105,8	98,5	93,5	88,3	80,1	71,0	64,4	57,0	49,3	41,1
TRENT5	LAmx	D	47 000,0	107,8	100,4	95,4	90,3	82,2	73,2	66,6	59,3	51,3	43,0
TRENT5	SEL	A	3 000,0	99,0	94,3	91,0	87,7	82,3	76,1	71,5	66,3	60,4	53,9
TRENT5	SEL	A	5 000,0	99,6	94,8	91,6	88,2	82,7	76,4	71,8	66,5	60,5	54,1
TRENT5	SEL	A	7 000,0	100,5	95,5	92,3	88,8	83,3	76,9	72,2	66,9	60,9	54,4
TRENT5	SEL	A	9 000,0	101,5	96,4	93,1	89,5	83,9	77,5	72,8	67,5	61,4	54,9
TRENT5	SEL	D	30 000,0	104,9	100,0	97,0	93,6	88,2	82,0	77,4	72,0	65,9	59,0
TRENT5	SEL	D	35 000,0	106,0	101,4	98,4	95,1	89,8	83,7	79,2	73,8	67,6	60,9
TRENT5	SEL	D	40 000,0	107,1	102,7	99,7	96,5	91,4	85,4	80,9	75,6	69,4	62,7
TRENT5	SEL	D	47 000,0	108,6	104,4	101,5	98,4	93,3	87,3	82,8	77,6	71,6	65,1
TRENT7	LAmx	A	4 000,0	93,6	86,6	81,9	77,1	69,4	61,2	55,3	48,7	41,2	33,4
TRENT7	LAmx	A	12 000,0	95,1	88,1	83,3	78,4	70,7	62,3	56,2	49,4	41,8	33,8
TRENT7	LAmx	D	31 000,0	102,6	95,4	90,6	85,5	77,3	68,0	61,1	53,3	45,0	36,6
TRENT7	LAmx	D	41 000,0	102,6	95,3	90,5	85,4	77,4	68,5	62,0	54,7	46,6	38,1
TRENT7	LAmx	D	52 000,0	105,6	98,5	93,8	88,8	80,8	72,0	65,5	58,3	50,2	41,8
TRENT7	LAmx	D	62 000,0	108,7	101,6	96,9	91,9	83,9	75,1	68,9	62,0	54,1	45,5
TRENT7	SEL	A	4 000,0	97,4	93,0	89,8	86,6	81,5	75,7	71,4	66,3	60,5	54,1
TRENT7	SEL	A	12 000,0	98,4	94,0	90,8	87,6	82,4	76,5	72,1	67,0	61,1	54,6

NPD_ID	Noise metric	Op type	Power setting (the 'Power Parameter' field in the 'Aircraft' table specifies the power setting type and unit)	L_200ft	L_400ft	L_630ft	L_1000ft	L_2000ft	L_4000ft	L_6300ft	L_10000ft	L_16000ft	L_25000ft
TRENT7	SEL	D	31 000,0	104,2	99,6	96,5	93,1	87,7	81,2	76,2	70,6	64,3	57,6
TRENT7	SEL	D	41 000,0	104,0	99,8	96,9	93,7	88,3	82,2	77,7	72,3	66,2	59,7
TRENT7	SEL	D	52 000,0	106,4	102,4	99,6	96,6	91,5	85,5	81,1	75,9	69,9	63,4
TRENT7	SEL	D	62 000,0	109,1	105,1	102,4	99,5	94,6	88,9	84,5	79,4	73,4	67,3
TRENT8	LAmx	A	7 000,0	93,6	85,9	80,9	75,9	68,1	59,5	53,3	46,7	39,2	30,3
TRENT8	LAmx	A	14 000,0	96,4	88,7	83,6	78,3	70,1	61,2	54,9	48,2	40,6	31,8
TRENT8	LAmx	A	22 000,0	98,7	90,8	85,6	80,2	71,8	62,8	56,5	49,7	42,0	33,1
TRENT8	LAmx	A	28 000,0	100,2	91,9	86,7	81,3	72,9	63,8	57,5	50,8	43,2	34,4
TRENT8	LAmx	D	32 000,0	100,4	93,4	88,5	83,3	74,9	65,7	59,4	52,6	44,8	35,6
TRENT8	LAmx	D	42 000,0	102,1	95,3	90,6	85,5	77,2	68,1	61,9	55,3	47,7	38,6
TRENT8	LAmx	D	52 000,0	103,8	97,1	92,5	87,5	79,3	70,4	64,3	57,8	50,3	41,3
TRENT8	LAmx	D	62 000,0	105,7	99,0	94,4	89,6	81,6	72,9	66,9	60,4	52,8	43,8
TRENT8	LAmx	D	72 000,0	107,9	101,3	96,9	92,1	84,6	76,2	70,3	63,8	56,3	47,4
TRENT8	LAmx	D	80 000,0	110,5	104,0	99,6	95,1	88,0	80,3	74,4	67,9	60,5	52,0
TRENT8	SEL	A	7 000,0	97,4	92,1	88,8	85,3	80,0	74,0	69,6	64,8	59,3	52,8
TRENT8	SEL	A	14 000,0	99,6	94,6	91,3	87,8	82,2	75,9	71,2	66,2	60,4	53,7
TRENT8	SEL	A	22 000,0	101,6	96,7	93,3	89,7	83,9	77,4	72,7	67,6	61,8	55,2
TRENT8	SEL	A	28 000,0	103,1	97,9	94,5	90,8	84,9	78,3	73,6	68,6	63,0	56,6
TRENT8	SEL	D	32 000,0	102,6	98,4	95,3	91,8	85,9	79,1	74,2	69,1	63,5	57,2
TRENT8	SEL	D	42 000,0	104,5	100,4	97,4	94,0	88,2	81,5	76,8	71,9	66,5	60,4

NPD_ID	Noise metric	Op type	Power setting (the 'Power Parameter' field in the 'Aircraft' table specifies the power setting type and unit)	L_200ft	L_400ft	L_630ft	L_1000ft	L_2000ft	L_4000ft	L_6300ft	L_10000ft	L_16000ft	L_25000ft
TRENT8	SEL	D	52 000,0	106,1	102,1	99,2	95,9	90,3	83,9	79,3	74,4	69,1	63,1
TRENT8	SEL	D	62 000,0	107,6	103,8	101,0	97,8	92,4	86,2	81,7	77,0	71,6	65,3
TRENT8	SEL	D	72 000,0	109,5	105,8	103,1	100,1	95,0	89,2	84,9	80,2	74,8	68,3
TRENT8	SEL	D	80 000,0	111,6	108,0	105,4	102,7	98,0	92,7	88,7	84,2	78,7	72,0
TRENT9	LAmx	A	4 000,0	93,1	86,6	82,2	77,5	69,9	61,4	55,3	48,6	41,2	33,5
TRENT9	LAmx	A	6 000,0	93,4	86,8	82,3	77,6	70,0	61,5	55,5	48,8	41,4	33,6
TRENT9	LAmx	A	9 000,0	93,9	87,2	82,6	77,9	70,3	61,8	55,7	49,1	41,6	33,9
TRENT9	LAmx	A	13 000,0	94,2	87,7	83,2	78,5	71,0	62,5	56,4	49,7	42,1	34,3
TRENT9	LAmx	D	40 000,0	98,9	92,4	87,8	83,0	75,1	66,4	60,2	53,3	45,6	37,4
TRENT9	LAmx	D	50 000,0	101,1	94,9	90,3	85,5	77,6	68,9	62,7	55,8	48,2	40,1
TRENT9	LAmx	D	60 000,0	104,1	98,0	93,5	88,6	80,8	72,0	65,7	58,7	50,9	42,7
TRENT9	LAmx	D	80 000,0	107,0	101,2	97,0	92,3	84,6	76,0	69,8	62,8	55,0	46,8
TRENT9	SEL	A	4 000,0	98,5	93,7	90,5	87,2	82,0	76,0	71,5	66,4	60,6	54,3
TRENT9	SEL	A	6 000,0	98,7	93,8	90,6	87,3	82,1	76,1	71,6	66,6	60,8	54,5
TRENT9	SEL	A	9 000,0	99,2	94,2	91,0	87,7	82,4	76,4	72,0	66,9	61,1	54,8
TRENT9	SEL	A	13 000,0	99,8	95,0	91,8	88,5	83,2	77,3	72,8	67,7	61,7	55,2
TRENT9	SEL	D	40 000,0	102,7	98,2	95,0	91,6	86,3	80,3	75,8	70,8	64,9	58,5
TRENT9	SEL	D	50 000,0	104,7	100,4	97,4	94,1	88,9	83,0	79,0	73,6	67,8	61,4
TRENT9	SEL	D	60 000,0	107,5	103,5	100,6	97,4	92,2	86,2	81,8	76,7	70,8	64,4
TRENT9	SEL	D	80 000,0	110,3	106,6	103,7	100,7	95,7	89,9	85,5	80,4	74,6	68,4

NPD_ID	Noise metric	Op type	Power setting (the 'Power Parameter' field in the 'Aircraft' table specifies the power setting type and unit)	L_200ft	L_400ft	L_630ft	L_1000ft	L_2000ft	L_4000ft	L_6300ft	L_10000ft	L_16000ft	L_25000ft
TSIO52	LAmx	A	30,0	83,1	76,9	72,6	68,3	61,5	54,1	48,7	42,8	36,4	29,5
TSIO52	LAmx	A	100,0	95,4	89,1	84,9	80,5	73,7	66,3	60,9	55,1	48,8	42,0
TSIO52	LAmx	D	30,0	83,1	76,9	72,6	68,3	61,5	54,1	48,7	42,8	36,4	29,5
TSIO52	LAmx	D	100,0	95,4	89,1	84,9	80,5	73,7	66,3	60,9	55,1	48,8	42,0
TSIO52	SEL	A	30,0	84,6	80,6	77,9	75,1	70,5	65,3	61,4	57,1	52,2	46,8
TSIO52	SEL	A	100,0	97,6	93,6	90,9	88,0	83,4	78,3	74,4	70,1	65,3	59,9
TSIO52	SEL	D	30,0	84,6	80,6	77,9	75,1	70,5	65,3	61,4	57,1	52,2	46,8
TSIO52	SEL	D	100,0	97,6	93,6	90,9	88,0	83,4	78,3	74,4	70,1	65,3	59,9
V2522A	LAmx	A	2 000,0	89,7	83,1	78,5	73,4	65,3	56,3	49,8	42,6	34,5	26,3
V2522A	LAmx	A	2 700,0	89,9	83,3	78,6	73,6	65,5	56,5	49,9	42,8	34,7	26,6
V2522A	LAmx	A	6 000,0	91,8	85,0	80,0	74,8	66,6	57,6	51,0	43,7	35,5	27,2
V2522A	LAmx	D	10 000,0	94,8	86,3	80,5	74,7	66,4	57,4	50,9	43,8	36,0	27,9
V2522A	LAmx	D	14 000,0	96,6	88,4	83,2	78,2	70,3	61,5	55,1	47,9	39,8	31,5
V2522A	LAmx	D	18 000,0	101,4	93,9	89,1	84,0	76,1	67,2	60,8	53,6	46,0	37,7
V2522A	LAmx	D	21 000,0	103,1	95,8	91,0	86,1	78,2	69,4	63,2	56,3	48,6	40,5
V2522A	SEL	A	2 000,0	93,7	89,5	86,3	82,8	77,0	70,6	65,6	60,2	53,9	47,2
V2522A	SEL	A	2 700,0	93,9	89,7	86,4	82,9	77,1	70,7	65,8	60,4	54,0	47,4
V2522A	SEL	A	6 000,0	95,6	91,3	87,9	84,1	78,2	71,5	66,7	61,2	54,7	47,9
V2522A	SEL	D	10 000,0	94,9	90,1	86,7	83,3	77,9	71,7	67,0	61,7	55,7	49,1
V2522A	SEL	D	14 000,0	98,2	94,0	90,9	87,6	82,1	75,7	71,0	65,4	59,2	52,6

NPD_ID	Noise metric	Op type	Power setting (the 'Power Parameter' field in the 'Aircraft' table specifies the power setting type and unit)	L_200ft	L_400ft	L_630ft	L_1000ft	L_2000ft	L_4000ft	L_6300ft	L_10000ft	L_16000ft	L_25000ft
V2522A	SEL	D	18 000,0	102,6	98,6	95,6	92,5	87,2	81,1	76,6	71,3	65,3	58,9
V2522A	SEL	D	21 000,0	103,9	100,0	97,1	94,1	89,0	83,0	78,7	73,6	67,8	61,7
V2525	LAmix	A	3 000,0	89,2	83,0	78,2	73,7	66,0	57,5	51,0	44,1	36,5	28,3
V2525	LAmix	A	6 950,0	91,0	84,5	80,0	75,0	67,7	58,9	53,0	46,0	38,2	30,0
V2525	LAmix	D	10 500,0	93,1	86,5	82,0	77,2	69,9	61,1	55,3	48,7	41,2	33,4
V2525	LAmix	D	13 150,0	95,2	88,8	84,0	79,5	72,1	63,5	57,9	51,0	43,8	36,0
V2525	LAmix	D	18 500,0	100,0	93,4	88,8	84,0	76,7	68,1	62,2	56,0	48,6	40,8
V2525	LAmix	D	23 000,0	104,8	98,5	93,9	89,0	81,8	73,3	67,8	61,0	53,5	45,4
V2525	SEL	A	3 000,0	91,9	88,5	85,4	81,9	76,7	71,2	66,9	61,7	55,7	49,1
V2525	SEL	A	6 950,0	94,3	90,2	86,6	83,5	78,3	72,8	68,4	63,7	57,5	51,5
V2525	SEL	D	10 500,0	95,8	91,6	88,5	85,3	80,2	74,7	70,2	65,7	59,5	54,1
V2525	SEL	D	13 150,0	98,1	94,0	91,0	87,9	82,7	76,9	72,7	68,2	62,7	56,7
V2525	SEL	D	18 500,0	102,4	98,5	95,7	92,7	87,7	82,2	78,2	73,2	67,8	61,7
V2525	SEL	D	23 000,0	106,2	102,7	99,7	97,0	92,2	86,7	82,7	78,0	72,7	66,5
V2527A	LAmix	A	2 000,0	89,3	82,8	78,2	73,4	65,8	57,4	51,2	44,4	36,7	28,6
V2527A	LAmix	A	2 700,0	89,5	83,0	78,3	73,5	65,8	57,4	51,3	44,4	36,7	28,6
V2527A	LAmix	A	6 000,0	91,6	84,7	79,5	74,2	66,5	58,0	51,9	45,0	37,2	29,1
V2527A	LAmix	D	10 000,0	94,8	86,3	80,5	74,8	66,5	57,6	51,1	44,0	36,2	28,2
V2527A	LAmix	D	14 000,0	96,7	88,6	83,5	78,4	70,5	61,7	55,3	48,1	40,1	31,8
V2527A	LAmix	D	19 000,0	101,2	93,9	89,0	84,0	76,1	67,3	61,1	54,1	46,3	38,2

NPD_ID	Noise metric	Op type	Power setting (the 'Power Parameter' field in the 'Aircraft' table specifies the power setting type and unit)	L_200ft	L_400ft	L_630ft	L_1000ft	L_2000ft	L_4000ft	L_6300ft	L_10000ft	L_16000ft	L_25000ft
V2527A	LAmx	D	23 000,0	104,0	96,9	92,2	87,3	79,4	70,8	64,7	57,9	50,3	42,0
V2527A	SEL	A	2 000,0	93,1	89,1	86,1	82,9	77,7	71,7	67,1	61,9	55,8	49,2
V2527A	SEL	A	2 700,0	93,3	89,2	86,2	83,0	77,7	71,8	67,2	62,0	55,8	49,3
V2527A	SEL	A	6 000,0	94,7	90,5	87,4	83,9	78,5	72,3	67,7	62,5	56,3	49,7
V2527A	SEL	D	10 000,0	95,0	90,2	86,8	83,5	78,1	71,8	67,2	61,9	55,9	49,4
V2527A	SEL	D	14 000,0	98,3	93,9	90,9	87,6	82,1	75,8	71,1	65,6	59,4	52,8
V2527A	SEL	D	19 000,0	102,5	98,4	95,5	92,3	87,2	81,1	76,7	71,5	65,7	59,4
V2527A	SEL	D	23 000,0	104,6	100,7	98,0	95,0	90,0	84,3	80,0	75,1	69,5	63,3
V2530	LAmx	A	2 000,0	91,8	84,4	79,6	74,5	66,3	57,2	50,5	43,2	35,2	26,9
V2530	LAmx	A	6 000,0	93,3	86,1	81,2	75,9	67,6	58,5	51,8	44,4	36,2	27,8
V2530	LAmx	D	13 000,0	96,8	88,3	83,2	78,2	70,3	61,4	54,9	47,6	39,6	31,3
V2530	LAmx	D	18 000,0	99,6	92,1	87,3	82,3	74,3	65,4	59,0	51,9	44,1	35,9
V2530	LAmx	D	22 000,0	103,3	96,1	91,4	86,4	78,5	69,8	63,6	56,9	49,2	41,1
V2530	LAmx	D	27 000,0	107,0	100,0	95,3	90,4	82,6	74,2	68,1	61,5	54,0	45,8
V2530	SEL	A	2 000,0	94,6	90,2	86,9	83,4	77,7	71,2	66,2	60,5	54,3	47,6
V2530	SEL	A	6 000,0	96,0	91,4	88,1	84,6	78,8	72,3	67,4	61,7	55,4	48,6
V2530	SEL	D	13 000,0	98,3	94,3	91,2	87,8	82,2	75,8	71,0	65,5	59,2	52,5
V2530	SEL	D	18 000,0	100,8	96,8	93,8	90,7	85,4	79,4	74,8	69,5	63,6	57,1
V2530	SEL	D	22 000,0	104,1	100,1	97,3	94,3	89,3	83,5	79,1	74,0	68,4	62,2
V2530	SEL	D	27 000,0	107,5	103,5	100,9	98,0	93,2	87,6	83,4	78,6	73,0	67,1

Table I-10

Spectral classes

Spectral Class ID	Op Type	Description	L _{50Hz}	L _{63Hz}	L _{80Hz}	L _{100Hz}	L _{125Hz}	L _{160Hz}	L _{200Hz}	L _{250Hz}	L _{315Hz}	L _{400Hz}	L _{500Hz}
101	Departure	2/3-Engine.LowByPass.Tfan	59,5	61,6	62,8	73,1	80,8	78,3	72,3	75,8	75,9	73,6	71,8
102	Departure	2-Engine.HighByPass.Tfan	59,7	60,0	68,5	73,0	73,8	70,4	67,6	71,4	68,7	72,8	73,2
103	Departure	2-Engine.HighByPass.Tfan	56,7	66,1	70,1	72,8	76,6	73,0	74,5	77,0	75,3	72,2	72,2
104	Departure	2-Engine.Low/MidByPass.Tfan	57,3	56,3	61,5	67,7	71,4	73,7	67,0	72,1	73,8	74,1	71,3
105	Departure	2-Engine.HighByPass.Tfan	66,5	60,4	67,1	75,0	78,2	79,3	71,5	76,7	74,4	74,6	72,3
106	Departure	4-Engine.Tfan+Supersonic	62,5	57,4	66,9	73,7	75,5	74,0	71,4	73,4	73,4	75,7	75,8
107	Departure	4-Engine.Tfan	58,6	62,7	69,1	74,1	76,0	74,3	74,1	74,4	74,0	73,6	73,2
108	Departure	4-Engine.Tfan	66,2	66,2	66,2	72,2	80,8	67,9	67,6	72,0	70,0	70,7	71,1
109	Departure	2-Engine.Tprop+1/2-Engine.Piston	64,7	67,1	73,1	89,4	84,5	76,3	89,3	80,7	79,3	79,3	81,6
110	Departure	2-Engine.Tprop+4-Engine.Piston	71,4	69,9	79,9	87,4	76,5	80,9	86,2	86,0	85,6	81,2	76,8
111	Departure	2-Engine.Tprop	78,0	76,0	90,0	103,0	82,0	85,0	97,0	89,0	94,0	80,0	79,0

Spectral Class ID	Op Type	Description	L _{50Hz}	L _{63Hz}	L _{80Hz}	L _{100Hz}	L _{125Hz}	L _{160Hz}	L _{200Hz}	L _{250Hz}	L _{315Hz}	L _{400Hz}	L _{500Hz}
112	Departure	2/4-Engine.Tprop	74,0	95,0	92,0	75,0	96,0	90,0	74,9	78,0	75,0	75,0	74,1
113	Departure	2-Engine.Tjet+Tfan.Business	58,5	57,9	60,7	67,0	71,2	72,6	70,3	72,7	72,9	73,5	72,8
136	Departure	2-Engine.Tfan.Business	59,7	60,0	68,5	73,0	73,8	70,4	67,6	71,4	68,7	72,8	73,2
137	Departure	2-Engine.Tfan.Business	58,6	62,7	69,1	74,1	76,0	74,3	74,1	74,4	74,0	73,6	73,2
138	Departure	2-Engine.Tfan.Business	66,2	66,2	66,2	72,2	80,8	67,9	67,6	72,0	70,0	70,7	71,1
201	Approach	2/3-Engine.LowByPass.Tfan	64,9	65,5	66,2	66,7	73,0	77,6	74,8	70,7	76,6	72,5	74,4
202	Approach	2-Engine.Low/HighByPass.Tfan	68,5	68,5	68,5	68,4	68,5	70,9	73,3	67,3	72,6	72,5	72,1
203	Approach	2-Engine.HighByPass.Tfan+Business	67,3	68,9	69,6	70,0	70,2	74,0	74,7	73,1	71,3	74,1	72,9
204	Approach	2-Engine.Low/MidByPass.Tfan	58,8	57,1	59,4	68,0	72,8	73,7	69,1	72,3	74,8	75,6	73,6
205	Approach	2-Engine.HighByPass.Tfan	68,3	60,7	64,6	67,4	78,4	74,8	71,4	72,4	72,0	72,4	71,6
206	Approach	4-Engine.Tjet+Tfan	63,3	65,4	64,1	63,2	66,0	66,6	69,6	70,1	71,5	67,1	71,0
207	Approach	4-Engine.Tfan	67,0	61,1	62,7	64,1	70,4	74,4	71,8	68,4	76,3	72,3	73,5

Spectral Class ID	Op Type	Description	L _{50Hz}	L _{63Hz}	L _{80Hz}	L _{100Hz}	L _{125Hz}	L _{160Hz}	L _{200Hz}	L _{250Hz}	L _{315Hz}	L _{400Hz}	L _{500Hz}
208	Approach	4-Engine.Tjet+Tfan	66,7	65,0	61,7	65,4	72,9	76,2	73,0	68,1	72,7	70,7	72,1
209	Approach	4-Engine.Tfan	60,0	59,0	60,0	69,0	71,0	70,0	69,0	69,0	69,0	69,0	70,0
210	Approach	2-Engine.Tprop	65,0	70,0	65,0	72,0	77,0	68,0	78,0	85,0	86,0	79,0	73,0
211	Approach	2-Engine.Tprop	71,3	65,4	74,7	88,1	77,1	80,3	86,9	80,0	86,8	78,2	75,5
212	Approach	2-Engine.Tprop	72,0	68,0	79,0	71,0	73,0	84,0	74,0	75,0	73,0	72,0	71,0
213	Approach	4-Engine.Tprop+Piston	64,0	73,0	76,0	71,0	82,0	83,0	67,0	71,0	70,0	69,0	69,0
214	Approach	2/4-Engine.Tprop	61,8	69,8	61,8	58,8	67,8	70,8	62,8	59,8	62,8	60,8	60,8
215	Approach	1/2-Engine.Piston	83,0	98,0	83,0	79,0	91,0	80,0	85,0	76,0	75,0	73,0	72,0
216	Approach	2-Engine.Tjet+Tfan	68,0	63,1	64,7	71,2	74,3	75,0	70,3	72,6	72,1	73,3	71,3
235	Approach	2-Engine.Tfan.Business	67,3	68,9	69,6	70,0	70,2	74,0	74,7	73,1	71,3	74,1	72,9
236	Approach	2-Engine.Tfan.Business	62,7	64,8	63,5	62,6	65,4	66,0	69,0	69,5	70,8	66,5	70,4
237	Approach	2-Engine.Tfan.Business	67,0	61,1	62,7	64,1	70,4	74,4	71,8	68,4	76,3	72,3	73,5
238	Approach	2-Engine.Tfan.Business	60,0	59,0	60,0	69,0	71,0	70,0	69,0	69,0	69,0	69,0	70,0

Spectral Class ID	Op. Type	Description	L150Hz	L160Hz	L175Hz	L200Hz	L250Hz	L315Hz	L400Hz	L500Hz	L630Hz	L800Hz	L1000Hz	L1250Hz	L1600Hz	L2000Hz	L2500Hz	L3150Hz	L4000Hz	L5000Hz	L6300Hz	L8000Hz	L10000Hz	
213	Approach	4-Engine.Tprop +Piston	64,0	73,0	76,0	71,0	67,0	70,0	69,0	69,0	68,0	67,0	70,0	70,0	69,0	67,0	64,0	60,0	57,0	54,0	49,0	42,0	32,0	20,0
214	Approach	2/4-Engine.Tprop	61,8	69,8	61,8	62,8	60,8	60,8	60,8	60,8	59,8	60,8	70,0	70,0	67,8	59,8	56,8	52,8	49,8	47,8	45,8	35,8	27,8	
215	Approach	1/2-Engine.Piston	83,0	98,0	83,0	75,0	72,0	71,0	73,0	72,0	73,0	71,0	70,0	80,0	85,0	65,0	64,0	60,0	57,0	53,0	49,0	43,0	32,0	
216	Approach	2-Engine.Tjet +Tfan	68,0	63,1	64,7	72,1	71,3	70,3	73,3	71,3	70,7	70,3	70,0	74,3	70,3	67,8	66,3	64,4	62,0	57,2	64,2	52,2	43,5	33,1
235	Approach	2-Engine.Tfan. Business	67,3	68,9	69,6	73,1	74,1	71,6	74,1	72,9	73,1	71,6	70,0	70,2	74,7	67,4	70,8	69,7	72,1	64,2	58,2	49,6	38,9	
236	Approach	2-Engine.Tfan. Business	62,7	64,8	63,5	70,8	66,5	71,2	66,5	70,4	69,8	71,2	69,4	65,4	69,0	62,3	61,4	62,1	58,5	58,2	52,7	49,6	40,0	
237	Approach	2-Engine.Tfan. Business	67,0	61,1	62,7	76,3	72,3	70,5	72,3	73,5	71,2	70,5	70,0	70,4	71,8	67,5	69,4	71,1	72,5	65,7	59,3	52,2	45,6	
238	Approach	2-Engine.Tfan. Business	60,0	59,0	60,0	69,0	69,0	69,0	69,0	70,0	69,0	69,0	70,0	71,0	70,0	72,0	72,0	70,0	66,0	63,0	57,0	49,0	38,0	

This section introduces complementary data for general aviation aircraft.

GASEPF and GASEPV data

Table I-11

GASEPF and GASEPV aircraft types

ACFTID	Description	Engine Type	Numb of Engines	Weight Class	Owner Category	MGTOW (lb)	MCLAW (lb)	Max Landing Dist (ft)	Max Sea Level Static Thrust (lb)	Noise Chapter	NPD_ID	Power Parameter	Approach Spectral Class ID	Departure Spectral Class ID	Lateral Directivity Identifier
GASEPF	Single-engine fixed pitch propeller aircraft	Piston	1	Small	General Aviation	2 200	2 200	1 160	560	0	GASEPF	Percent	215	109	Prop
GASEPV	Single-engine variable pitch propeller aircraft	Piston	1	Small	General Aviation	3 000	3 000	1 111	790	0	GASEPV	Percent	215	109	Prop

(the associated spectral data are available in the ANP 'Spectral Classes' table)

Table I-12

Departure and Arrival flight profile data for GASEPF and GASEPV aircraft

ACFTID	Op type	Profile_ID	Stage length	Point number	Distance (ft)	Altitude AFE (ft)	TAS (kt)	Percentage of Max Static Thrust (%)
GASEPF	A	APP_3_DEG	1	1	- 114 486,8	6 000,0	109,4	34,21
GASEPF	A	APP_3_DEG	1	2	- 57 243,4	3 000,0	71,8	37,57
GASEPF	A	APP_3_DEG	1	3	- 28 621,7	1 500,0	60,0	40,59
GASEPF	A	APP_3_DEG	1	4	- 19 081,1	1 000,0	59,6	39,85
GASEPF	A	APP_3_DEG	1	5	0,0	0,0	58,7	38,43
GASEPF	A	APP_3_DEG	1	6	47,2	0,0	55,7	27,20

ACFTID	Op type	Profile_ID	Stage length	Point number	Distance (ft)	Altitude AFE (ft)	TAS (kt)	Percentage of Max Static Thrust (%)
GASEPF	A	APP_3_DEG	1	7	472,0	0,0	30,0	10,00
GASEPF	A	APP_5_DEG	1	1	-68 580,3	6 000,0	109,4	18,03
GASEPF	A	APP_5_DEG	1	2	-34 290,2	3 000,0	71,8	22,59
GASEPF	A	APP_5_DEG	1	3	-17 145,1	1 500,0	60,0	26,14
GASEPF	A	APP_5_DEG	1	4	-11 430,1	1 000,0	59,6	25,67
GASEPF	A	APP_5_DEG	1	5	0,0	0,0	58,7	24,75
GASEPF	A	APP_5_DEG	1	6	47,2	0,0	55,7	27,20
GASEPF	A	APP_5_DEG	1	7	472,0	0,0	30,0	10,00
GASEPF	D	DEFAULT_DEP	1	1	0,0	0,0	0,0	113,06
GASEPF	D	DEFAULT_DEP	1	2	972,8	0,0	62,1	113,06
GASEPF	D	DEFAULT_DEP	1	3	2 077,9	51,4	73,1	96,32
GASEPF	D	DEFAULT_DEP	1	4	13 665,7	1 000,0	74,1	98,31
GASEPF	D	DEFAULT_DEP	1	5	16 079,7	1 097,7	84,3	86,65
GASEPF	D	DEFAULT_DEP	1	6	17 079,7	1 155,4	84,4	81,16
GASEPF	D	DEFAULT_DEP	1	7	49 057,1	3 000,0	86,8	84,60
GASEPF	D	DEFAULT_DEP	1	8	97 253,2	5 500,0	90,1	89,42
GASEPF	D	DEFAULT_DEP	1	9	140 694,0	7 500,0	92,9	93,53
GASEPF	D	DEFAULT_DEP	1	10	202 700,4	10 000,0	96,6	99,04
GASEPV	A	APP_3_DEG	1	1	-114 486,8	6 000,0	109,4	24,34
GASEPV	A	APP_3_DEG	1	2	-57 243,4	3 000,0	79,4	26,37
GASEPV	A	APP_3_DEG	1	3	-28 621,7	1 500,0	67,5	45,05

ACFTID	Op type	Profile_ID	Stage length	Point number	Distance (ft)	Altitude AFE (ft)	TAS (kt)	Percentage of Max Static Thrust (%)
GASEPV	A	APP_3_DEG	1	4	- 19 081,1	1 000,0	67,0	44,24
GASEPV	A	APP_3_DEG	1	5	0,0	0,0	66,0	42,66
GASEPV	A	APP_3_DEG	1	6	42,8	0,0	62,6	31,00
GASEPV	A	APP_3_DEG	1	7	428,0	0,0	30,0	10,00
GASEPV	A	APP_5_DEG	1	1	- 68 580,3	6 000,0	109,4	8,70
GASEPV	A	APP_5_DEG	1	2	- 34 290,2	3 000,0	79,4	12,04
GASEPV	A	APP_5_DEG	1	3	- 17 145,1	1 500,0	67,5	31,28
GASEPV	A	APP_5_DEG	1	4	- 11 430,1	1 000,0	67,0	30,72
GASEPV	A	APP_5_DEG	1	5	0,0	0,0	66,0	29,62
GASEPV	A	APP_5_DEG	1	6	42,8	0,0	62,6	31,00
GASEPV	A	APP_5_DEG	1	7	428,0	0,0	30,0	10,00
GASEPV	D	DEFAULT_DEP	1	1	0,0	0,0	0,0	163,92
GASEPV	D	DEFAULT_DEP	1	2	861,8	0,0	55,6	163,92
GASEPV	D	DEFAULT_DEP	1	3	1 302,6	42,7	66,0	138,25
GASEPV	D	DEFAULT_DEP	1	4	2 963,7	172,0	90,2	101,67
GASEPV	D	DEFAULT_DEP	1	5	9 389,6	1 000,0	91,3	103,50
GASEPV	D	DEFAULT_DEP	1	6	10 985,9	1 102,9	101,6	93,36
GASEPV	D	DEFAULT_DEP	1	7	11 985,9	1 200,6	101,8	86,89
GASEPV	D	DEFAULT_DEP	1	8	30 407,6	3 000,0	104,5	90,57
GASEPV	D	DEFAULT_DEP	1	9	57 858,2	5 500,0	108,5	95,72
GASEPV	D	DEFAULT_DEP	1	10	81 543,2	7 500,0	111,9	100,13
GASEPV	D	DEFAULT_DEP	1	11	113 618,2	10 000,0	116,4	106,03

Table I-13

NPD data for GASEPF and GASEPV aircraft

NPD_ID	Noise metric	Op type	Power setting — Percentage of Maximum Static Thrust (%)	L_200ft	L_400ft	L_630ft	L_1000ft	L_2000ft	L_4000ft	L_6300ft	L_10000ft	L_16000ft	L_25000ft
GASEPF	LAmx	A	30,00	72,2	65,9	61,6	57,2	50,3	43,1	38,0	32,7	27,0	20,9
GASEPF	LAmx	A	100,00	84,9	78,6	74,4	70,0	63,2	55,8	50,4	44,6	38,3	31,5
GASEPF	LAmx	D	30,00	72,2	65,9	61,6	57,2	50,3	43,1	38,0	32,7	27,0	20,9
GASEPF	LAmx	D	100,00	84,9	78,6	74,4	70,0	63,2	55,8	50,4	44,6	38,3	31,5
GASEPF	SEL	A	30,00	74,2	70,1	67,3	64,4	59,8	54,8	51,2	47,4	43,2	38,6
GASEPF	SEL	A	100,00	87,1	83,1	80,4	77,5	72,9	67,8	63,9	59,6	54,8	49,4
GASEPF	SEL	D	30,00	74,2	70,1	67,3	64,4	59,8	54,8	51,2	47,4	43,2	38,6
GASEPF	SEL	D	100,00	87,1	83,1	80,4	77,5	72,9	67,8	63,9	59,6	54,8	49,4
GASEPV	LAmx	A	30,00	82,8	73,9	69,6	65,2	58,3	51,1	46,0	40,7	35,0	28,9
GASEPV	LAmx	A	100,00	92,4	86,1	81,9	77,5	70,7	63,3	57,9	52,1	45,8	39,0
GASEPV	LAmx	D	30,00	82,8	73,9	69,6	65,2	58,3	51,1	46,0	40,7	35,0	28,9
GASEPV	LAmx	D	100,00	92,4	86,1	81,9	77,5	70,7	63,3	57,9	52,1	45,8	39,0
GASEPV	SEL	A	30,00	81,7	77,6	74,8	71,9	67,3	62,3	58,7	54,9	50,7	46,1
GASEPV	SEL	A	100,00	94,6	90,6	87,9	85,0	80,4	75,3	71,4	67,1	62,3	56,9
GASEPV	SEL	D	30,00	81,7	77,6	74,8	71,9	67,3	62,3	58,7	54,9	50,7	46,1
GASEPV	SEL	D	100,00	94,6	90,6	87,9	85,0	80,4	75,3	71,4	67,1	62,3	56,9

Aircraft classes data

Aircraft group	Examples of aircraft types (maximum take-off mass)
P 1.0	Dewald Sunny, Flightstar II, Ikarus C42, Quicksilver MXL II, Sherpa, Stratos, Tecnam P92 Echo
P 1.1	DG-400 (500 kg), Grob 109B (900 kg), H 36 Dimona (800 kg), Scheibe SF 25C (700 kg)
P 1.2	DR 400/180R (1 000 kg), H 36 Dimona (800 kg), PZL-104 'Wilga 35' (1 200 kg), Scheibe SF 25 (700 kg)
P 1.3	DR 400/180R (1 000 kg), Cessna 172N (1 000 kg), Piper PA-28-181 (1 200 kg), Piper PA-34-200 (1 900 kg)

Aircraft Noise and Performance data for the four classes are presented in the following tables:

Table I-14

Noise group data for P 1.0, P 1.1, P 1.2, P 1.3 aircraft classes

NOISE_ID,C,12	THRSET_TYP,C,1	MODEL_TYPE,C,1	SPECT_APP,N,3,0	SPECT_DEP,N,3,0	SPECT_AFB,N,3,0
P1.0	P	I	215	109	0
P1.1	P	I	215	109	0
P1.2	P	I	215	109	0
P1.3	P	I	215	109	0

ACFT_ID,C,12	ACFT_DESCR,C,40	WGT_CAT,C,1	OWNER_CAT,C,1	ENG_TYPE,C,1	NOISE_CAT,C,1	NOISE_ID,C,12	NUMB_ENG,N,1,0	THR_RESTOR,C,1	MX_GW_TKO,N,7,0	MX_GW_LND,N,7,0	MX_DS_STOP,N,5,0	COEFF_TYPE,C,1	THR_STATIC,N,6,0
P1.0	Ultralights	S	G	P	0	P1.0	1	N	0	0	0	P	100
P1.1	Motorgliders	S	G	P	0	P1.1	1	N	0	0	0	P	100
P1.2	Prop MTOM <= 2 t towing gliders	S	G	P	0	P1.2	1	N	0	0	0	P	100
P1.3	Prop MTOM <= 2 t	S	G	P	0	P1.3	1	N	0	0	0	P	100

Table I-15

Arrival and Departure flight profile data for P 1.0, P 1.1, P 1.2, P 1.3 aircraft classes

ACFT_ID,C,12	OP_TYPE,C,1	PROF_ID1,C,8	PROF_ID2,C,1	WEIGHT,N,7,0
P1.0	A	DEFAULT	1	100
P1.0	D	DEFAULT	1	100
P1.1	A	DEFAULT	1	100
P1.1	D	DEFAULT	1	100
P1.2	A	DEFAULT	1	100
P1.2	D	DEFAULT	1	100
P1.3	A	DEFAULT	1	100
P1.3	D	DEFAULT	1	100

Table I-16

Noise Profile points data for P 1.0, P 1.1, P 1.2, P 1.3 aircraft classes

ACFT_ID,C,12	OP_TYPE,C,1	PROF_ID1,C,8	PROF_ID2,C,1	PT_NUM,N,3,0	DISTANCE,N,10,1	ALTITUDE,N,7,1	SPEED,N,5,1	THR_SET,N,9,2	OP_MODE,C,1
P1.0	A	DEFAULT	1	1	- 114 486	6 000	50,5	70	A
P1.0	A	DEFAULT	1	2	- 18 917,1	1 000	50,5	70	A
P1.0	A	DEFAULT	1	3	- 15 636,3	828,1	50,5	70	A
P1.0	A	DEFAULT	1	4	164	0	50,5	70	A
P1.0	A	DEFAULT	1	5	656,2	0	19,4	30	A
P1.0	D	DEFAULT	1	1	0	0	19,4	100	D
P1.0	D	DEFAULT	1	2	328,1	0	62,2	100	D
P1.0	D	DEFAULT	1	3	12 986,3	1 000	62,2	100	D

ACFT_ID,C,12	OP_TYPE,C,1	PROF_ID1,C,8	PROF_ID2,C,1	PT_NUM,N,3,0	DISTANCE,N,10,1	ALTITUDE,N,7,1	SPEED,N,5,1	THR_SET,N,9,2	OP_MODE,C,1
P1.0	D	DEFAULT	1	4	42 000	3 000	65	100	D
P1.0	D	DEFAULT	1	5	200 000	10 000	68	100	D
P1.1	A	DEFAULT	1	1	- 114 486	6 000	50,5	70	A
P1.1	A	DEFAULT	1	2	- 18 589	1 000	50,5	70	A
P1.1	A	DEFAULT	1	3	- 15 308,2	828,1	50,5	70	A
P1.1	A	DEFAULT	1	4	492,1	0	50,5	70	A
P1.1	A	DEFAULT	1	5	656,2	0	19,4	30	A
P1.1	D	DEFAULT	1	1	0	0	19,4	100	D
P1.1	D	DEFAULT	1	2	656,2	0	66,1	100	D
P1.1	D	DEFAULT	1	3	13 314,4	1 000	66,1	100	D
P1.1	D	DEFAULT	1	4	43 000	3 000	70	100	D
P1.1	D	DEFAULT	1	5	200 000	10 000	73,9	100	D
P1.2	A	DEFAULT	1	1	- 114 486	6 000	60,3	70	A
P1.2	A	DEFAULT	1	2	- 18 589	1 000	60,3	70	A
P1.2	A	DEFAULT	1	3	- 15 308,2	828,1	60,3	70	A
P1.2	A	DEFAULT	1	4	492,1	0	60,3	70	A
P1.2	A	DEFAULT	1	5	1 476,4	0	19,4	30	A
P1.2	D	DEFAULT	1	1	0	0	19,4	100	D
P1.2	D	DEFAULT	1	2	1 312,3	0	62,2	100	D
P1.2	D	DEFAULT	1	3	17 705,8	1 000	62,2	100	D
P1.2	D	DEFAULT	1	4	50 000	3 000	64	100	D
P1.2	D	DEFAULT	1	5	200 000	10 000	66,1	100	D

ACFT_ID,C,12	OP_TYPE,C,1	PROF_ID1,C,8	PROF_ID2,C,1	PT_NUM,N,3,0	DISTANCE,N,10,1	ALTITUDE,N,7,1	SPEED,N,5,1	THR_SET,N,9,2	OP_MODE,C,1
P1.3	A	DEFAULT	1	1	- 114 486	6 000	60,3	70	A
P1.3	A	DEFAULT	1	2	- 18 589	1 000	60,3	70	A
P1.3	A	DEFAULT	1	3	- 15 308,2	828,1	60,3	70	A
P1.3	A	DEFAULT	1	4	492,1	0	60,3	70	A
P1.3	A	DEFAULT	1	5	1 476,4	0	19,4	30	A
P1.3	D	DEFAULT	1	1	0	0	19,4	100	D
P1.3	D	DEFAULT	1	2	820,2	0	70	100	D
P1.3	D	DEFAULT	1	3	10 344	1 000	70	100	D
P1.3	D	DEFAULT	1	4	40 000	3 000	75	100	D
P1.3	D	DEFAULT	1	5	200 000	10 000	83	100	D

Table I-17

NPD data for P 1.0, P 1.1, P 1.2, P 1.3 aircraft classes

NOISE_ID, C,12	NOISE_ TYPE,C,1	OP_MODE, C,1	THR_SET, N,9,2	L_200,N,5,1	L_400,N,5,1	L_630,N,5,1	L_1000, N,5,1	L_2000, N,5,1	L_4000, N,5,1	L_6300, N,5,1	L_10000, N,5,1	L_16000, N,5,1	L_25000, N,5,1
P1.0	M	A	30	55,2	49	44,8	40,4	33,6	26,3	21,2	15,6	9,3	2,8
P1.0	M	A	70	65,2	59	54,8	50,4	43,6	36,3	31,2	25,6	19,3	12,8
P1.0	M	D	88	71,2	65	60,8	56,4	49,6	42,3	37,2	31,6	25,3	18,8
P1.0	M	D	100	75,2	69	64,8	60,4	53,6	46,3	41,2	35,6	29,3	22,8
P1.0	S	A	30	54,7	51,4	49,1	46,7	42,8	38,4	35,2	31,4	27,1	22,3
P1.0	S	A	70	64,7	61,4	59,1	56,7	52,8	48,4	45,2	41,4	37,1	32,3
P1.0	S	D	88	70,7	67,4	65,1	62,7	58,8	54,4	51,2	47,4	43,1	38,3

NOISE_ID, C,1,2	NOISE TYPE,C,1	OP_MODE, C,1	THR_SET, N,9,2	L_200,N,5,1	L_400,N,5,1	L_630,N,5,1	L_1000, N,5,1	L_2000, N,5,1	L_4000, N,5,1	L_6300, N,5,1	L_10000, N,5,1	L_16000, N,5,1	L_25000, N,5,1
P1.0	S	D	100	74,7	71,4	69,1	66,7	62,8	58,4	55,2	51,4	47,1	42,3
P1.1	M	A	30	60,2	54	49,8	45,4	38,6	31,3	26,2	20,6	14,3	7,8
P1.1	M	A	70	70,2	64	59,8	55,4	48,6	41,3	36,2	30,6	24,3	17,8
P1.1	M	D	82	74,2	68	63,8	59,4	52,6	45,3	40,2	34,6	28,3	21,8
P1.1	M	D	100	80,2	74	69,8	65,4	58,6	51,3	46,2	40,6	34,3	27,8
P1.1	S	A	30	59,7	56,4	54,1	51,7	47,8	43,4	40,2	36,4	32,1	27,3
P1.1	S	A	70	69,7	66,4	64,1	61,7	57,8	53,4	50,2	46,4	42,1	37,3
P1.1	S	D	82	73,7	70,4	68,1	65,7	61,8	57,4	54,2	50,4	46,1	41,3
P1.1	S	D	100	79,7	76,4	74,1	71,7	67,8	63,4	60,2	56,4	52,1	47,3
P1.2	M	A	30	64,4	58,2	53,9	49,5	42,6	35,1	29,8	24	17,5	10,6
P1.2	M	A	70	74,4	68,2	63,9	59,5	52,6	45,1	39,8	34	27,5	20,6
P1.2	M	D	76	76,4	70,2	65,9	61,5	54,6	47,1	41,8	36	29,5	22,6
P1.2	M	D	100	84,4	78,2	73,9	69,5	62,6	55,1	49,8	44	37,5	30,6
P1.2	S	A	30	63,9	60,5	58,2	55,8	51,8	47,2	43,8	39,8	35,2	30,1
P1.2	S	A	70	73,9	70,5	68,2	65,8	61,8	57,2	53,8	49,8	45,2	40,1
P1.2	S	D	76	75,9	72,5	70,2	67,8	63,8	59,2	55,8	51,8	47,2	42,1
P1.2	S	D	100	83,9	80,5	78,2	75,8	71,8	67,2	63,8	59,8	55,2	50,1
P1.3	M	A	30	66,4	60,2	55,9	51,5	44,6	37,1	31,8	26	19,5	12,6
P1.3	M	A	70	76,4	70,2	65,9	61,5	54,6	47,1	41,8	36	29,5	22,6
P1.3	M	D	76	78,4	72,2	67,9	63,5	56,6	49,1	43,8	38	31,5	24,6
P1.3	M	D	100	86,4	80,2	75,9	71,5	64,6	57,1	51,8	46	39,5	32,6
P1.3	S	A	30	65,9	62,5	60,2	57,8	53,8	49,2	45,8	41,8	37,2	32,1

NOISE_ID, C,12	NOISE TYPE,C,1	OP_MODE, C,1	THR_SET, N,9,2	L_200,N,5,1	L_400,N,5,1	L_630,N,5,1	L_1000, N,5,1	L_2000, N,5,1	L_4000, N,5,1	L_6300, N,5,1	L_10000, N,5,1	L_16000, N,5,1	L_25000, N,5,1
P1.3	S	A	70	75,9	72,5	70,2	67,8	63,8	59,2	55,8	51,8	47,2	42,1
P1.3	S	D	76	77,9	74,5	72,2	69,8	65,8	61,2	57,8	53,8	49,2	44,1
P1.3	S	D	100	85,9	82,5	80,2	77,8	73,8	69,2	65,8	61,8	57,2	52,1

Helicopter Noise and Performance Data Set 1

This includes data for five helicopters classes, based on helicopter MTOM:

Table I-18

Helicopter Data Set 1 Description Table

ACFT_ID	Description	EngineTYPE	Number of Engines	Weight Class	Owner Category	MGTOW (lb)	MGLW (lb)	Max Landing Dist (ft)	Max Sea Level Static Thrust (lb)	Noise Chapter	NPD ID	Power Parameter	Approach Spectral Class ID	Departure Spectral Class ID	Lateral Dir- activity Identifier
H1.0	Helicopters with MTOM <= 1 t	Propeller	0	0	Helicopter	0	0	0	100	0	H1.0	SHP (% of Max Static Thrust)	215	109	Prop
H1.1	Helicopters with MTOM 1-3 t	Propeller	0	0	Helicopter	0	0	0	100	0	H1.1	SHP (% of Max Static Thrust)	215	109	Prop
H1.2	Helicopters with MTOM 3-5 t	Propeller	0	0	Helicopter	0	0	0	100	0	H1.2	SHP (% of Max Static Thrust)	215	109	Prop
H2.1	Helicopters with MTOM 5-10 t	Propeller	0	0	Helicopter	0	0	0	100	0	H2.1	SHP (% of Max Static Thrust)	215	109	Prop
H2.2	Helicopters with MTOM > 10 t	Propeller	0	0	Helicopter	0	0	0	100	0	H2.2	SHP (% of Max Static Thrust)	215	109	Prop

Table I-19

Helicopter Data Set 1 Departure Profiles

ACFT_ID	OP_TYPE	PROF_ID1	PROF_ID2	PT_NUM	DISTANCE (ft)	ALTITUDE (ft)	SPEED (kt)	THR_SET (%)	OP_MODE
H1.0	D	H1.0_S	1	1	0,0	0,0	3,9	100,00	D
H1.0	D	H1.0_S	1	2	9,8	6,6	5,8	100,00	D
H1.0	D	H1.0_S	1	3	32,8	16,4	9,7	100,00	D
H1.0	D	H1.0_S	1	4	295,3	49,2	40,8	100,00	D
H1.0	D	H1.0_S	1	5	5 687,5	1 000,0	60,3	100,00	D
H1.0	D	H1.0_S	1	6	8 968,3	1 000,0	64,1	100,00	D
H1.0	D	H1.0_S	1	7	200 000,0	1 000,0	64,1	100,00	D
H1.1	D	H1.1_S	1	1	0,0	0,0	3,9	100,00	D
H1.1	D	H1.1_S	1	2	9,8	6,6	5,8	100,00	D
H1.1	D	H1.1_S	1	3	32,8	16,4	9,7	100,00	D
H1.1	D	H1.1_S	1	4	295,3	49,2	40,8	100,00	D
H1.1	D	H1.1_S	1	5	6 298,3	1 000,0	64,1	100,00	D
H1.1	D	H1.1_S	1	6	9 579,2	1 000,0	70,0	100,00	D
H1.1	D	H1.1_S	1	7	200 000,0	1 000,0	70,0	100,00	D
H1.2	D	H1.2_S	1	1	0,0	0,0	3,9	100,00	D
H1.2	D	H1.2_S	1	2	9,8	6,6	5,8	100,00	D
H1.2	D	H1.2_S	1	3	32,8	16,4	9,7	100,00	D
H1.2	D	H1.2_S	1	4	295,3	49,2	40,8	100,00	D
H1.2	D	H1.2_S	1	5	6 298,3	1 000,0	70,0	100,00	D
H1.2	D	H1.2_S	1	6	9 579,2	1 000,0	75,8	100,00	D

ACFT_ID	OP_TYPE	PROF_ID1	PROF_ID2	PT_NUM	DISTANCE (ft)	ALTITUDE (ft)	SPEED (kt)	THR_SET (%)	OP_MODE
H1.2	D	H1.2_S	1	7	200 000,0	1 000,0	75,8	100,00	D
H2.1	D	H2.1_S	1	1	0,0	0,0	3,9	100,00	D
H2.1	D	H2.1_S	1	2	9,8	6,6	5,8	100,00	D
H2.1	D	H2.1_S	1	3	32,8	16,4	9,7	100,00	D
H2.1	D	H2.1_S	1	4	295,3	49,2	40,8	100,00	D
H2.1	D	H2.1_S	1	5	6 298,3	1 000,0	70,0	100,00	D
H2.1	D	H2.1_S	1	6	9 579,2	1 000,0	75,8	100,00	D
H2.1	D	H2.1_S	1	7	200 000,0	1 000,0	75,8	100,00	D
H2.2	D	H2.2_S	1	1	0,0	0,0	3,9	100,00	D
H2.2	D	H2.2_S	1	2	9,8	0,0	5,8	100,00	D
H2.2	D	H2.2_S	1	3	32,8	16,4	9,7	100,00	D
H2.2	D	H2.2_S	1	4	295,3	49,2	40,8	100,00	D
H2.2	D	H2.2_S	1	5	6 298,3	1 000,0	70,0	100,00	D
H2.2	D	H2.2_S	1	6	9 579,2	1 000,0	75,8	100,00	D
H2.2	D	H2.2_S	1	7	200 000,0	1 000,0	75,8	100,00	D

Table I-20

Helicopter Data Set 1 Arrival Profiles

ACFT_ID	OP_TYPE	PROF_ID1	PROF_ID2	PT_NUM	DISTANCE	ALTITUDE	SPEED	THR_SET	OP_MODE
H1.0	A	H1.0_L	1	1	- 200 000,0	1 000,0	64,1	100,00	A
H1.0	A	H1.0_L	1	2	- 10 836,6	1 000,0	64,1	100,00	A
H1.0	A	H1.0_L	1	3	- 7 555,8	1 000,0	60,3	100,00	A
H1.0	A	H1.0_L	1	4	- 295,3	44,1	40,8	100,00	A

ACFT_ID	OP_TYPE	PROF_ID1	PROF_ID2	PT_NUM	DISTANCE	ALTITUDE	SPEED	THR_SET	OP_MODE
H1.0	A	H1.0_L	1	5	- 32,8	9,6	9,7	100,00	A
H1.0	A	H1.0_L	1	6	- 9,8	6,6	5,8	100,00	A
H1.0	A	H1.0_L	1	7	0,0	0,0	3,9	100,00	A
H1.1	A	H1.1_L	1	1	- 200 000,0	1 000,0	70,0	100,00	A
H1.1	A	H1.1_L	1	2	- 8 401,5	1 000,0	70,0	100,00	A
H1.1	A	H1.1_L	1	3	- 5 120,6	1 000,0	64,1	100,00	A
H1.1	A	H1.1_L	1	4	- 295,3	62,0	40,8	100,00	A
H1.1	A	H1.1_L	1	5	- 32,8	11,0	9,7	100,00	A
H1.1	A	H1.1_L	1	6	- 9,8	6,6	5,8	100,00	A
H1.1	A	H1.1_L	1	7	0,0	0,0	3,9	100,00	A
H1.2	A	H1.2_L	1	1	- 200 000,0	1 000,0	75,8	100,00	A
H1.2	A	H1.2_L	1	2	- 9 563,0	1 000,0	75,8	100,00	A
H1.2	A	H1.2_L	1	3	- 6 282,2	1 000,0	70,0	100,00	A
H1.2	A	H1.2_L	1	4	- 295,3	51,8	40,8	100,00	A
H1.2	A	H1.2_L	1	5	- 32,8	10,2	9,7	100,00	A
H1.2	A	H1.2_L	1	6	- 9,8	6,6	5,8	100,00	A
H1.2	A	H1.2_L	1	7	0,0	0,0	3,9	100,00	A
H2.1	A	H2.1_L	1	1	- 200 000,0	1 000,0	75,8	100,00	A
H2.1	A	H2.1_L	1	2	- 9 563,0	1 000,0	75,8	100,00	A
H2.1	A	H2.1_L	1	3	- 6 282,2	1 000,0	70,0	100,00	A
H2.1	A	H2.1_L	1	4	- 295,3	51,8	40,8	100,00	A
H2.1	A	H2.1_L	1	5	- 32,8	10,2	9,7	100,00	A
H2.1	A	H2.1_L	1	6	- 9,8	6,6	5,8	100,00	A
H2.1	A	H2.1_L	1	6	- 9,8	6,6	5,8	100,00	A

ACFT_ID	OP_TYPE	PROF_ID1	PROF_ID2	PT_NUM	DISTANCE	ALTITUDE	SPEED	THR_SET	OP_MODE
H2.1	A	H2.1_L	1	7	0,0	0,0	3,9	100,00	A
H2.2	A	H2.2_L	1	1	- 200 000,0	1 000,0	75,8	100,00	A
H2.2	A	H2.2_L	1	2	- 9 604,4	1 000,0	75,8	100,00	A
H2.2	A	H2.2_L	1	3	- 6 323,6	1 000,0	70,0	100,00	A
H2.2	A	H2.2_L	1	4	- 295,3	45,2	40,8	100,00	A
H2.2	A	H2.2_L	1	5	- 32,8	3,6	9,7	100,00	A
H2.2	A	H2.2_L	1	6	- 9,8	0,0	5,8	100,00	A
H2.2	A	H2.2_L	1	7	0,0	0,0	3,9	100,00	A

Table I-21

Noise Characteristic data for Helicopter Data Set 1

NOISE_ID	THRSET_TYP	MODEL_TYPE	SPECT_APP	SPECT_DEP	SPECT_AFB
H1.0	Propeller	I	215	109	0
H1.1	Propeller	I	215	109	0
H1.2	Propeller	I	215	109	0
H2.1	Propeller	I	215	109	0
H2.2	Propeller	I	215	109	0

Table I-22
Noise Power Distance (NPD) data for Helicopter Data Set 1

NOISE_ID	NOISE_TYPE	OP_MODE	THR_SET	L_200	L_400	L_630	L_1000	L_2000	L_4000	L_6300	L_10000	L_16000	L_25000
H1.0	M	A	80,00	81,3	75,0	70,7	66,3	59,2	51,4	45,6	39,1	31,5	23,1
H1.0	M	A	100,00	84,3	78,0	73,7	69,3	62,2	54,4	48,6	42,1	34,5	26,1
H1.0	M	D	80,00	81,3	75,0	70,7	66,3	59,2	51,4	45,6	39,1	31,5	23,1
H1.0	M	D	100,00	84,3	78,0	73,7	69,3	62,2	54,4	48,6	42,1	34,5	26,1
H1.0	S	A	80,00	82,0	78,6	76,2	73,6	69,2	64,1	60,1	55,3	49,4	42,8
H1.0	S	A	100,00	85,0	81,6	79,2	76,6	72,2	67,1	63,1	58,3	52,4	45,8
H1.0	S	D	80,00	82,0	78,6	76,2	73,6	69,2	64,1	60,1	55,3	49,4	42,8
H1.0	S	D	100,00	85,0	81,6	79,2	76,6	72,2	67,1	63,1	58,3	52,4	45,8
H1.1	M	A	80,00	86,5	80,2	75,9	71,5	64,4	56,6	50,8	44,3	36,7	28,3
H1.1	M	A	100,00	89,5	83,2	78,9	74,5	67,4	59,6	53,8	47,3	39,7	31,3
H1.1	M	D	80,00	86,5	80,2	75,9	71,5	64,4	56,6	50,8	44,3	36,7	28,3
H1.1	M	D	100,00	89,5	83,2	78,9	74,5	67,4	59,6	53,8	47,3	39,7	31,3
H1.1	S	A	80,00	87,2	83,8	81,4	78,8	74,4	69,3	65,3	60,5	54,6	48,0
H1.1	S	A	100,00	90,2	86,8	84,4	81,8	77,4	72,3	68,3	63,5	57,6	51,0
H1.1	S	D	80,00	87,2	83,8	81,4	78,8	74,4	69,3	65,3	60,5	54,6	48,0
H1.1	S	D	100,00	90,2	86,8	84,4	81,8	77,4	72,3	68,3	63,5	57,6	51,0
H1.2	M	A	80,00	89,1	82,8	78,5	74,1	67,0	59,2	53,4	46,9	39,3	30,9
H1.2	M	A	100,00	92,1	85,8	81,5	77,1	70,0	62,2	56,4	49,9	42,3	33,9
H1.2	M	D	80,00	89,1	82,8	78,5	74,1	67,0	59,2	53,4	46,9	39,3	30,9
H1.2	M	D	100,00	92,1	85,8	81,5	77,1	70,0	62,2	56,4	49,9	42,3	33,9
H1.2	S	A	80,00	89,8	86,4	84,0	81,4	77,0	71,9	67,9	63,1	57,2	50,6
H1.2	S	A	100,00	92,8	89,4	87,0	84,4	80,0	74,9	70,9	66,1	60,2	53,6

NOISE_ID	NOISE_TYPE	OP_MODE	THR_SET	L_200	L_400	L_630	L_1000	L_2000	L_4000	L_6300	L_10000	L_16000	L_25000
H1.2	S	D	80,00	89,8	86,4	84,0	81,4	77,0	71,9	67,9	63,1	57,2	50,6
H1.2	S	D	100,00	92,8	89,4	87,0	84,4	80,0	74,9	70,9	66,1	60,2	53,6
H2.1	M	A	80,00	91,3	85,0	80,7	76,3	69,2	61,4	55,6	49,1	41,5	33,1
H2.1	M	A	100,00	94,3	88,0	83,7	79,3	72,2	64,4	58,6	52,1	44,5	36,1
H2.1	M	D	80,00	91,3	85,0	80,7	76,3	69,2	61,4	55,6	49,1	41,5	33,1
H2.1	M	D	100,00	94,3	88,0	83,7	79,3	72,2	64,4	58,6	52,1	44,5	36,1
H2.1	S	A	80,00	92,0	88,6	86,2	83,6	79,2	74,1	70,1	65,3	59,4	52,8
H2.1	S	A	100,00	95,0	91,6	89,2	86,6	82,2	77,1	73,1	68,3	62,4	55,8
H2.1	S	D	80,00	92,0	88,6	86,2	83,6	79,2	74,1	70,1	65,3	59,4	52,8
H2.1	S	D	100,00	95,0	91,6	89,2	86,6	82,2	77,1	73,1	68,3	62,4	55,8
H2.2	M	A	80,00	94,3	88,0	83,7	79,3	72,2	64,4	58,6	52,1	44,5	36,1
H2.2	M	A	100,00	97,3	91,0	86,7	82,3	75,2	67,4	61,6	55,1	47,5	39,1
H2.2	M	D	80,00	94,3	88,0	83,7	79,3	72,2	64,4	58,6	52,1	44,5	36,1
H2.2	M	D	100,00	97,3	91,0	86,7	82,3	75,2	67,4	61,6	55,1	47,5	39,1
H2.2	S	A	80,00	95,0	91,6	89,2	86,6	82,2	77,1	73,1	68,3	62,4	55,8
H2.2	S	A	100,00	98,0	94,6	92,2	89,6	85,2	80,1	76,1	71,3	65,4	58,8
H2.2	S	D	80,00	95,0	91,6	89,2	86,6	82,2	77,1	73,1	68,3	62,4	55,8
H2.2	S	D	100,00	98,0	94,6	92,2	89,6	85,2	80,1	76,1	71,3	65,4	58,8

Helicopter Noise and Performance Data Set 2

Data is provided for three helicopter classes, based on maximum take-off mass:

1. Light helicopter (LHEL) MTOM < 3 000 kg
2. Medium helicopter (MHEL) 3 000 kg < MTOM < 6 000 kg
3. Heavy helicopter (THEL) MTOM > 6 000 kg

Default arrival and departure flight profiles are provided as fixed point profiles. Default departure flight profiles assume climb to a level flight altitude of 1 000 ft (305 m) for each helicopter class. Where the level flight portion on departure or arrival differs locally from these values, it is recommended that the default profiles are adapted to reflect local circumstances.

Table I-23

Helicopter Data Set 2 Description Table

ACFT_ID	Description	EngineTYPE	Number of Engines	Weight Class	Owner Category	MGLOW (lb)	Max Landing Dist (ft)	Max Sea Level Static Thrust (lb)	Noise Chapter	NPD_ID	Power Parameter	Approach Spectral Class ID	Departure Spectral Class ID	Lateral Directivity Identifier
LHEL	Helicopters with MTOM ≤ 1 t	Turboprop	0	0	Helicopter	0	0	100	0	LHEL	SHP (% of Max Static Thrust)	215	112	Prop
MHEL	Helicopters with MTOM 1-3 t	Turboprop	0	0	Helicopter	0	0	100	0	MHEL	SHP (% of Max Static Thrust)	215	112	Prop
THEL	Helicopters with MTOM 3-5 t	Turboprop	0	0	Helicopter	0	0	100	0	THEL	SHP (% of Max Static Thrust)	215	112	Prop

Table I-24

Helicopter Data Set 2 Departure Profiles

ACFT_ID	Op Type	Profile ID	Stage Length	Point Number	Distance (ft)	Altitude (ft)	TAS (kt)	Corrected Net Thrust (%)	OP_MODE
LHEL	D	DEFAULT	1	1	0	0	1	50	X
LHEL	D	DEFAULT	1	2	10	0	3	50	X
LHEL	D	DEFAULT	1	3	20	16	5	50	X
LHEL	D	DEFAULT	1	4	102	16	5	60	D
LHEL	D	DEFAULT	1	5	561	30	50	60	D
LHEL	D	DEFAULT	1	6	2 297	515	70	60	D
LHEL	D	DEFAULT	1	7	4 032	1 001	90	70	D

ACFT_ID	Op Type	Profile ID	Stage Length	Point Number	Distance (ft)	Altitude (ft)	TAS (kt)	Corrected Net Thrust (%)	OP_MODE
LHEL	D	DEFAULT	1	8	7 014	1 001	100	70	D
LHEL	D	DEFAULT	1	9	10 000	1 001	110	70	D
MHEL	D	DEFAULT	1	1	0	0	1	50	D
MHEL	D	DEFAULT	1	2	10	0	2	50	D
MHEL	D	DEFAULT	1	3	20	16	3	50	D
MHEL	D	DEFAULT	1	4	102	16	30	50	D
MHEL	D	DEFAULT	1	5	561	30	60	50	D
MHEL	D	DEFAULT	1	6	4 032	1 001	65	75	D
MHEL	D	DEFAULT	1	7	6 785	1 001	100	75	D
MHEL	D	DEFAULT	1	8	10 000	1 001	126	75	D
THEL	D	DEFAULT	1	1	0	0	1	100	X
THEL	D	DEFAULT	1	2	10	0	2	100	X
THEL	D	DEFAULT	1	3	20	16	3	50	D
THEL	D	DEFAULT	1	4	102	16	30	50	D
THEL	D	DEFAULT	1	5	1 001	151	60	50	D
THEL	D	DEFAULT	1	5	4 679	1 000	65	75	D
THEL	D	DEFAULT	1	5	6 681	1 000	83	75	D
THEL	D	DEFAULT	1	5	8 679	1 000	100	75	D
THEL	D	DEFAULT	1	5	13 679	1 000	113	75	D
THEL	D	DEFAULT	1	5	18 679	1 000	126	75	D

Table I-25

Helicopter Data Set 2 Arrival Profiles

ACFT_ID	Op Type	Profile ID	Stage Length	Point Number	Distance (ft)	Altitude (ft)	TAS (kt)	Corrected Net Thrust (%)	OP_MODE
LHEL	D	DEFAULT	1	3	- 50 003	1 000	115	70	X
LHEL	D	DEFAULT	1	4	- 9 332	1 000	113	70	X
LHEL	D	DEFAULT	1	5	- 6 340	686	110	80	A
LHEL	D	DEFAULT	1	6	- 4 029	443	95	80	A
LHEL	D	DEFAULT	1	7	- 1 686	197	80	80	A
LHEL	D	DEFAULT	1	8	- 843	108	60	80	A
LHEL	D	DEFAULT	1	9	0	20	5	80	A
LHEL	D	DEFAULT	1	9	102	0	3	80	A
LHEL	D	DEFAULT	1	9	121	0	1	80	A
MHEL	D	DEFAULT	1	2	- 40 229	1 000	135	75	X
MHEL	D	DEFAULT	1	3	- 36 322	1 000	123	75	X
MHEL	D	DEFAULT	1	4	- 32 411	1 000	112	75	X
MHEL	D	DEFAULT	1	5	- 28 504	1 000	100	75	X
MHEL	D	DEFAULT	1	6	- 22 145	1 000	90	75	X
MHEL	D	DEFAULT	1	7	- 15 784	1 000	80	75	X
MHEL	D	DEFAULT	1	8	- 9 426	1 000	70	75	X
MHEL	D	DEFAULT	1	8	- 5 153	551	60	60	A
MHEL	D	DEFAULT	1	8	- 750	89	50	60	A
MHEL	D	DEFAULT	1	8	- 62	16	20	60	A
MHEL	D	DEFAULT	1	8	0	10	5	60	A
MHEL	D	DEFAULT	1	8	102	0	2	60	A

ACFT_ID	Op Type	Profile ID	Stage Length	Point Number	Distance (ft)	Altitude (ft)	TAS (kt)	Corrected Net Thrust (%)	OP_MODE
MHEL	D	DEFAULT	1	8	121	0	1	60	A
MHEL	D	DEFAULT	1	8	-40 229	1 000	135	75	X
MHEL	D	DEFAULT	1	8	-36 322	1 000	123	75	X
MHEL	D	DEFAULT	1	8	-32 411	1 000	112	75	X
MHEL	D	DEFAULT	1	8	-28 504	1 000	100	75	X
MHEL	D	DEFAULT	1	8	-22 145	1 000	90	75	X
MHEL	D	DEFAULT	1	8	-15 784	1 000	80	75	X
MHEL	D	DEFAULT	1	8	-9 426	1 000	70	75	X
MHEL	D	DEFAULT	1	8	-5 153	551	60	60	A
MHEL	D	DEFAULT	1	8	-750	89	50	60	A
MHEL	D	DEFAULT	1	8	-62	16	20	60	A
MHEL	D	DEFAULT	1	8	0	10	5	60	A
MHEL	D	DEFAULT	1	8	102	0	2	60	A
MHEL	D	DEFAULT	1	8	121	0	1	60	A

Table I-26

Noise Characteristic data for Helicopter Data Set 2

NOISE_ID	THRSET_TYP	MODEL_TTYPE	SPECT_APP	SPECT_DEP	SPECT_AFB
LHEL	P	I	215	109	0
MHEL	P	I	215	109	0
THEL	P	I	215	109	0

Table I-27

Noise Power Distance (NPD) data for three helicopter classes

NPD Identifier	Noise Descriptor	Power Setting	Op Mode	L_200ft	L_400ft	L_630ft	L_1000ft	L_2000ft	L_4000ft	L_6300ft	L_10000ft	L_16000ft	L_25000ft
LHEL	MAX	80	A	84,6	79,1	75,7	71,6	65,8	60,1	56	48,8	41,6	34,4
LHEL	MAX	70	X	88,4	82,9	79,5	75,6	70,3	65	61,6	55,4	49,2	43
LHEL	MAX	60	D	83,6	78,2	75,1	70,3	66,5	61,7	58,9	53,3	47,7	42,1
LHEL	MAX	50	S	91,7	85,3	81,5	76,5	69,4	61,5	56,5	49,6	42,7	35,8
LHEL	SEL	80	A	90,5	87,1	84,9	82,1	77,6	72,1	67,9	62,4	56,9	51,4
LHEL	SEL	70	X	90,4	87	84,7	81,9	77,5	72	68,1	62,9	57,7	52,5
LHEL	SEL	60	D	85,9	82,5	80,4	77,7	73,4	68,4	64,6	59,6	54,6	49,6
LHEL	SEL	50	S	85,9	82,5	80,4	77,7	73,4	68,4	64,6	59,6	54,6	49,6
MHEL	MAX	50	D	91,8	85,2	80,6	75,7	67,5	58,1	51,2	42,6	34	25,4
MHEL	MAX	60	A	90,2	83,9	80	75,3	68,4	60,9	55,8	49,5	43,2	36,9
MHEL	MAX	75	X	92,4	86	82	77,2	70	62,3	57,1	50,8	44,5	38,2
MHEL	SEL	50	D	91,2	87,2	84,8	80,8	75	68,1	63,7	57,6	51,5	45,4
MHEL	SEL	60	A	94,2	90,1	88,1	84,7	80	74,7	71,3	66	60,7	55,4
MHEL	SEL	75	X	89,3	85,3	82,8	78,9	73,1	66,6	62,6	57	51,4	45,8
THEL	MAX	50	D	91,2	85,2	81,7	76,3	68,8	60,4	54,9	46	37,1	28,2
THEL	MAX	60	A	90	84,1	80,7	75,5	68,5	60,6	55,3	48	40,7	33,4
THEL	MAX	75	X	92,4	86,4	82,9	77,5	70,1	61,6	55,7	48,1	40,5	32,9
THEL	MAX	100	S	100,2	93,8	90,3	84,9	77,5	69,3	64,3	56,5	48,7	40,9
THEL	SEL	50	D	92,8	89,3	87,4	84	79,2	73,5	69,6	63,7	57,8	51,9

NPD Identifier	Noise Descriptor	Power Setting	Op Mode	L_200ft	L_400ft	L_630ft	L_1000ft	L_2000ft	L_4000ft	L_6300ft	L_10000ft	L_16000ft	L_25000ft
THEL	SEL	60	A	91,6	88,2	86,4	83,2	78,8	73,7	70	64,7	59,4	54,1
THEL	SEL	75	X	94	90,5	88,6	85,2	80,5	74,7	70,4	64,8	59,2	53,6
THEL	SEL	100	S	92,8	89,3	87,4	84	79,2	73,5	69,6	63,7	57,8	51,9